

Welch Allyn[®]
ELI[®] 150c/250c
12-LEAD RESTING ELECTROCARDIOGRAPH
SERVICE MANUAL

Manufactured by Welch Allyn, Inc., Skaneateles Falls, NY U.S.A.

CE
0459



CAUTION: Federal law restricts this device to sale by or on the order of a physician.

©2019 Welch Allyn This document contains confidential information that belongs to Welch Allyn, Inc. No part of this document may be transmitted, reproduced, used, or disclosed outside of the receiving organization without the express written consent of Welch Allyn, Inc. Welch Allyn is a registered trademark of Welch Allyn, Inc. E-Scribe, ELI, and VERITAS are trademarks of Welch Allyn, Inc. Cisco® is the registered trademark of Cisco Systems, Inc. DICOM® is the registered trademark of the National Electrical Manufacturers Association for its standards publications relating to digital communications of medical information.

For patent information, please visit www.welchallyn.com/patents

For information about any Welch Allyn product, visit: <https://www.welchallyn.com/en/about-us/locations.html>

Customer Service and Technical Support: <https://www.welchallyn.com/en/other/contact-us.html> 1.888.667.8272,
mor_tech.support@hillrom.com



9516-177-50-ENG Rev T (also refer to TDR pages when making revision changes)
Revision Date: 2023-01



(150c) 901129 ELECTROCARDIOGRAPH
(250c) 901131 ELECTROCARDIOGRAPH



Welch Allyn, Inc.
4341 State Street Road
Skaneateles Falls, NY 13153 USA

www.welchallyn.com

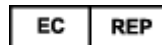

EU IMPORTER

Welch Allyn Limited
Navan Business Park, Dublin Road,
Navan, Co. Meath C15 AW22
Ireland

TABLE OF CONTENTS

NOTICES	1
MANUFACTURER’S RESPONSIBILITY	1
RESPONSIBILITY OF THE CUSTOMER.....	1
EQUIPMENT IDENTIFICATION.....	1
COPYRIGHT AND TRADEMARK NOTICES.....	1
OTHER IMPORTANT INFORMATION	1
NOTICE TO EU USERS AND/OR PATIENTS	1
DISPOSAL.....	1
WARRANTY INFORMATION	2
YOUR WELCH ALLYN WARRANTY.....	2
USER SAFETY INFORMATION	3
WARNING(S)	3
CAUTION(S).....	6
NOTE(S)	7
WIRELESS DATA TRANSMISSION	8
WLAN OPTION	8
EQUIPMENT SYMBOLS AND MARKINGS	11
SYMBOL DELINEATION.....	11
ELECTROMAGNETIC COMPATIBILITY (EMC)	13
GUIDANCE AND MANUFACTURER’S DECLARATION: ELECTROMAGNETIC EMISSIONS	14
GUIDANCE AND MANUFACTURER’S DECLARATION: ELECTROMAGNETIC IMMUNITY	14
GUIDANCE AND MANUFACTURER’S DECLARATION: ELECTROMAGNETIC IMMUNITY	15
RECOMMENDED SEPARATION DISTANCES BETWEEN PORTABLE AND MOBILE RF COMMUNICATIONS EQUIPMENT AND THE EQUIPMENT	16
REGULATORY RADIO COMPLIANCE	17
<i>Federal Communications Commission (FCC)</i>	17
<i>Industry Canada (IC) Emissions</i>	18
<i>Declaración de conformidad Mexico</i>	18
<i>European Union</i>	19
RADIO COMPLIANCE TABLE	20
MAINTENANCE & CLEANING	22
RECOMMENDED TOOLS AND SUPPLIES.....	22
PREVENTIVE MAINTENANCE	23
DEVICE CLEANING & DISINFECTING.....	27
ELI 150/250c PREVENTIVE MAINTENANCE REPORT.....	28
DEVICE CONFIGURATION	29
SETTING TECHNICIAN PASSWORD	29
CONFIGURATION MENUS	29
SUMMARY OF CONFIGURATION MENUS.....	30
CONFIGURATION SETTINGS.....	33
UNIT DISASSEMBLY	42
REMOVAL OF THE UNIT FROM CART	43
COVER ASSEMBLY REMOVAL.....	434
WRITER REMOVAL.....	455
KEYBOARD REMOVAL	522

INSTALLATION OF THE RIBBON CABLE TO THE KEYPAD ASSEMBLY	555
I/O BOARD REMOVAL	566
BATTERY REPLACEMENT.....	599
ITEM DESCRIPTION LISTING (150C)	61
ITEM DESCRIPTION LISTING (250C)	64
ITEM IDENTIFICATION TABLE (BOTH MODELS).....	67
DEVICE SPECIFICATIONS.....	855
ELI 150c SPECIFICATIONS.....	855
ELI 250c SPECIFICATIONS.....	866
TROUBLESHOOTING.....	877
SYSTEM TROUBLESHOOTING CHART	877
ECG TROUBLESHOOTING CHART	877
TRANSMISSION TROUBLESHOOTING CHART	877
TRANSMISSION TROUBLESHOOTING CHART (CONTINUED)	888
PAPER CUE FAULT	888
TEST MENU.....	888
CONFORMANCE TESTING.....	90
CONFORMANCE TESTING	90
POWER TESTING.....	90
FUNCTIONAL TESTING.....	91
DEVICE CLEANING.....	933
SAFETY TESTING	933
ELI 150C/250C TEST DATA RECORD	944
ELI 150C/250C COMMUNICATION OPTIONS	955
COMMUNICATION OPTIONS	955
COMMUNICATION ERROR MESSAGES	955
COMMUNICATION OPTIONS (SOFTWARE ONLY).....	966
COMMUNICATION OPTIONS (HARDWARE + SOFTWARE)	966
Modem	966

NOTICES

Manufacturer's Responsibility

Welch Allyn, Inc. is responsible for the effects on safety and performance only if:

- Assembly operations, extensions, readjustments, modifications, or repairs are carried out only by persons authorized by Welch Allyn, Inc.
- The device is used in accordance with the instructions for use.

Responsibility of the Customer

The user of this device is responsible for ensuring the implementation of a satisfactory maintenance schedule. Failure to do so may cause undue failure and possible health hazards.

Equipment Identification

Welch Allyn, Inc. equipment is identified by a serial and reference number on the back of the device. Care should be taken so that these numbers are not defaced.

Copyright and Trademark Notices

This document contains information that is protected by copyright. All rights are reserved. No part of this document may be photocopied, reproduced, or translated to another language without prior written consent of Welch Allyn, Inc.

Other Important Information

The information in this document is subject to change without notice.

Welch Allyn, Inc. makes no warranty of any kind with regard to this material including, but not limited to, implied warranties of merchantability and fitness for a particular purpose. Welch Allyn, Inc. assumes no responsibility for any errors or omissions that may appear in this document. Welch Allyn, Inc. makes no commitment to update or to keep current the information contained in this document.

Notice to EU Users and/or Patients

Any serious incident that has occurred in relation to the device, should be reported to the manufacturer and the competent authority of the Member State in which the user and/or patient is established.

Disposal

This product and its accessories must be disposed of according to the local laws and regulations. Do not dispose of this product as unsorted municipal waste. For more specific disposal information see www.welchallyn.com/weee.

WARRANTY INFORMATION

Your Welch Allyn Warranty

WELCH ALLYN, INC. (hereafter referred to as “Welch Allyn”) warrants that components within Welch Allyn products (hereafter referred to as “Product/s”) will be free from defects in workmanship and materials for the number of years specified on documentation accompanying the product, or previously agreed to by the purchaser and Welch Allyn, or if not otherwise noted, for a period of twenty-four (24) months from the date of shipment.

Consumable, disposable or single use products such as, but not limited to, PAPER or ELECTRODES are warranted to be free from defects in workmanship and materials for a period of 90 days from the date of shipment or the date of first use, whichever is sooner.

Reusable product such as, but not limited to, BATTERIES, BLOOD PRESSURE CUFFS, BLOOD PRESSURE HOSES, TRANSDUCER CABLES, Y-CABLES, PATIENT CABLES, LEAD WIRES, MAGNETIC STORAGE MEDIUMS, CARRY CASES or MOUNTS, are warranted to be free from defects in workmanship and materials for a period of 90 days. This warranty does not apply to damage to the Product/s caused by any or all of the following circumstances or conditions:

- a) Freight damage;
- b) Parts and/or accessories of the Product/s not obtained from or approved by Welch Allyn;
- c) Misapplication, misuse, abuse, and/or failure to follow the Product/s instruction sheets and/or information guides;
- d) Accident; a disaster affecting the Product/s;
- e) Alterations and/or modifications to the Product/s not authorized by Welch Allyn;
- f) Other events outside of Welch Allyn’s reasonable control or not arising under normal operating conditions.

THE REMEDY UNDER THIS WARRANTY IS LIMITED TO THE REPAIR OR REPLACEMENT WITHOUT CHARGE FOR LABOR OR MATERIALS, OR ANY PRODUCT/S FOUND UPON EXAMINATION BY WELCH ALLYN TO HAVE BEEN DEFECTIVE. This remedy shall be conditioned upon receipt of notice by Welch Allyn of any alleged defects promptly after discovery thereof within the warranty period. Welch Allyn’s obligations under the foregoing warranty will further be conditioned upon the assumption by the purchaser of the Product/s (i) of all carrier charges with respect to any Product/s returned to Welch Allyn’s principal place or any other place as specifically designated by Welch Allyn or an authorized distributor or representative of Welch Allyn, and (ii) all risk of loss in transit. It is expressly agreed that the liability of Welch Allyn is limited and that Welch Allyn does not function as an insurer. A purchaser of a Product/s, by its acceptance and purchase thereof, acknowledges and agrees that Welch Allyn is not liable for loss, harm, or damage due directly or indirectly to an occurrence or consequence therefrom relating to the Product/s. If Welch Allyn should be found liable to anyone under any theory (except the expressed warranty set forth herein) for loss, harm, or damage, the liability of Welch Allyn shall be limited to the lesser of the actual loss, harm, or damage, or the original purchase price of the Product/s when sold.

EXCEPT AS SET FORTH HEREIN WITH RESPECT TO REIMBURSEMENT OF LABOR CHARGES, A PURCHASER’S SOLE EXCLUSIVE REMEDY AGAINST WELCH ALLYN FOR CLAIMS RELATING TO THE PRODUCT/S FOR ANY AND ALL LOSSES AND DAMAGES RESULTING FROM ANY CAUSE SHALL BE THE REPAIR OR REPLACEMENT OF DEFECTIVE PRODUCT/S TO THE EXTENT THAT THE DEFECT IS NOTICED AND WELCH ALLYN IS NOTIFIED WITHIN THE WARRANTY PERIOD. IN NO EVENT, INCLUDING THE CLAIM FOR NEGLIGENCE, SHALL WELCH ALLYN BE LIABLE FOR INCIDENTAL, SPECIAL, OR CONSEQUENTIAL DAMAGES, OR FOR ANY OTHER LOSS, DAMAGE, OR EXPENSE OF ANY KIND, INCLUDING LOSS OF PROFITS, WHETHER UNDER TORT, NEGLIGENCE OR STRICT LIABILITY THEORIES OF LAW, OR OTHERWISE. THIS WARRANTY IS EXPRESSLY IN LIEU OF ANY OTHER WARRANTIES, EXPRESS OR IMPLIED, INCLUDING, BUT NOT LIMITED TO THE IMPLIED WARRANTY OF MERCHANTABILITY AND THE WARRANTY OF FITNESS FOR A PARTICULAR PURPOSE.

USER SAFETY INFORMATION



WARNING:

Means there is the possibility of personal injury to you or others.



Caution:

Means there is the possibility of damage to the device.

Note:

Provides information to further assist in the use of the device.



WARNING(S)

- This manual gives important information about the use and safety of this device. Deviating from operating procedures, misuse or misapplication of the device, or ignoring specifications and recommendations could result in increased risk of harm to users, patients and bystanders, or damage to the device.
- Device captures and presents data reflecting a patient's physiological condition that when reviewed by a trained physician or clinician can be useful in determining a diagnosis; however, the data should not be used as a sole means for determining a patient's diagnosis.
- Users are expected to be licensed clinical professionals knowledgeable about medical procedures and patient care, and adequately trained in the use of this device. Before attempting to use this device for clinical applications, the operator must read and understand the contents of the user manual and other accompanying documents. Inadequate knowledge or training could result in increased risk of harm to users, patients and bystanders, or damage to the device. Contact Welch Allyn service for additional training options.
- To ensure that electrical safety is maintained during operation from AC (~) power, the device must be plugged into a hospital-grade outlet.
- Only use parts and accessories supplied with the device and available through Welch Allyn, Inc.
- Patient cables intended for use with the device include series resistance (9 Kohm minimum) in each lead for defibrillation protection. Patient cables should be checked for cracks or breakage prior to use.
- Conductive parts of the patient cable, electrodes, and associated connections of type CF applied parts, including the neutral conductor of the patient cable and electrodes, should not come into contact with other conductive parts including earth ground.
- ECG electrodes could cause skin irritation; patients should be examined for signs of irritation or inflammation.
- To avoid the possibility of serious injury or death during patient defibrillation, do not come into contact with device or patient cables. Additionally, proper placement of defibrillator paddles in relation to the electrodes is required to minimize harm to the patient.

- This device was designed to use the electrodes specified in the user manual. Proper clinical procedure must be employed to prep the electrode sites and to monitor the patient for excessive skin irritation, inflammation, or other adverse reactions. Electrodes are intended for short-term use and should be removed from the patient promptly following testing.
- To avoid potential for spread of disease or infection, single-use disposable components (e.g., electrodes) must not be reused. To maintain safety and effectiveness, electrodes must not be used beyond their expiration date.
- A possible explosion hazard exists. Do not use the device in the presence of a flammable anesthetic mixture.
- Where the integrity of external protective earth conductor arrangement is in doubt, the device shall be operated from its internal electrical power source.
- To improve immunity to potential interfering electromagnetic signals, shielded cabling is recommended when connecting the device to a network.
- Medical devices have been designed to have a higher degree of protection against electric shock than, for instance, information technology equipment because patients often are connected to multiple devices and also may be more prone to the adverse effect of electric currents than healthy persons. All equipment that is connected to the patient, can be touched by the patient, or can be touched by another person while that person touches the patient at the same time, should have the same level of protection against electric shock as medical equipment. The ELI 150c and ELI 250c are medical devices that have been designed to be connected to other devices for the purpose of receiving and transmitting data. Certain measures must be taken to prevent the risk of excessive electric current flow through the operator or patient when connected:
- All electrical equipment that is **not medical electrical equipment** must be placed outside of the “patient environment,” defined by applicable safety standards to be at least 1.5 meters (5 feet) from the patient. Alternatively, non-medical equipment may be provided with additional protection such as an additional protective earth connection.
- All **medical electrical equipment** that has a physical connection to the ELI 150c/ELI 250c or the patient or is in the patient environment must comply with applicable safety standards for medical electrical devices.
- All electrical equipment that is **not medical electrical equipment** and has a physical connection to the ELI 150c/ELI 250c must comply with applicable safety standards, such as IEC 60950 for information technology equipment. This includes information network equipment connected through the LAN connector.
- Conductive (metal) parts that can be touched by the operator in normal use and that are connected to **non-medical equipment** should not be brought into the patient environment. Examples are connectors for shielded Ethernet or USB cables.
- If **multiple devices** are connected to each other or to the patient, device chassis and patient leakage currents may be increased, and should be measured for compliance with applicable standards for medical electrical systems.
- Avoid the use of **portable multiple socket outlets**. If used and not compliant with medical electrical device standards, an additional protective earth connection is required.

- After defibrillation pulse, electrocardiograph has a maximum recovery time of 5 seconds.
- To prevent electric shock due to unequal ground potentials that may exist between points of a distributed network system or fault conditions in external network connected equipment, network cable shielding (where used) must be connected to protective earth ground appropriate to the area where the device is used.
- The device has not been designed for use with high-frequency (HF) surgical equipment and does not provide a protective means against hazards to the patient.
- When the 40 Hz filter is used, the frequency response requirement for diagnostic ECG equipment cannot be met. The 40 Hz filter significantly reduces high-frequency components of the ECG and pacemaker spike amplitudes, and is recommended only if high-frequency noise cannot be reduced by proper procedures.
- The quality of the signal produced by the device may be adversely affected by the use of other medical equipment, including but not limited to defibrillators and ultrasound machines.
- For proper operation and the safety of users or patients and bystanders, equipment and accessories must be connected only as described in this manual. Do not connect a telephone line cable to the LAN connector.
- Some Welch Allyn electrocardiographs can be equipped with a GPRS (cellular modem) or wireless LAN (WLAN) module for transmitting ECG records. Device labeling and the presence of an antenna port will indicate if your device is equipped with such a module. If so equipped, the following notices apply:
 - The GPRS module operates in allocated frequency bands depending on the model. Identification of the installed GPRS module can be found on a label on the bottom of the device.
 - MultiTech Systems, Inc. Model MTSMC-H5: 850/900/1700(AWS)/1900/2100 MHz
 - The WLAN identification can be found on a label on the bottom of the device.
 - B&B Electronics Model WLNN-AN-MR551: 2400 MHz
(model subject to change without notice)

- Use of the GPRS or WLAN module may interfere with other equipment operating in the vicinity. Check with local authorities or spectrum management officials in your facility to determine if restrictions apply to the use of this feature in your area.
- Do not transmit via the GPRS or WLAN module with a missing or damaged antenna. Replace a damaged antenna immediately.
- Use only the antenna supplied for use with this device. Unauthorized antennas, modifications, or attachments could damage the GSM module and may contravene local RF emission regulations or invalidate type approval.
- To ensure compliance with current regulations limiting both maximum RF output power and human exposure to radio frequency radiation, a separation distance of at least 20 cm must be maintained between the device's antenna and the head and body of the user and any nearby persons at all times. To help prevent degradation of RF signal and to avoid excess RF energy absorption, do not touch the antenna during data transmission.
- The GPRS and WLAN modules comply with applicable RF safety standards including standards and recommendations for the protection of public exposure to RF electromagnetic energy that have been established by governmental bodies and other qualified organizations, such as the following:
 - Federal Communications Commission (FCC)
 - Directives of the European Community
 - Directorate General V in Matters of Radio Frequency Electromagnetic Energy
- Proper functioning backup items such as spare lead wires, front-end device, and other equipment are recommended on hand to prevent delayed treatment due to an inoperable device.



Caution(s)

- To prevent possible damage to the keyboard, do not use sharp or hard objects to depress keys, only use fingertips.
- Do not attempt to clean the device or patient cables by submersing into a liquid, autoclaving, or steam cleaning as this may damage equipment or reduce its usable life. Wipe the exterior surfaces with a warm water and mild detergent solution and then dry with a clean cloth. Use of unspecified cleaning/disinfecting agents, failure to follow recommended procedures, or contact with unspecified materials could result in increased risk of harm to users, patients and bystanders, or damage to the device.
- No user-serviceable parts inside. Screw removal by qualified service personnel only. Damaged or suspected inoperative equipment must be immediately removed from use and must be checked/repared by qualified service personnel prior to continued use.
- The rechargeable internal battery is a sealed lead-acid type and it is totally maintenance free. If the battery appears to become defective, refer to Welch Allyn Service Department.
- Do not pull or stretch patient cables as this could result in mechanical and/or electrical failures. Patient cables should be stored after forming them into a loose loop.
- No calibration or special equipments are needed for the proper operation or maintenance of the device.
- When necessary, dispose of the device, its components and accessories (e.g., batteries, cables, electrodes), and/or packing materials in accordance with local regulations.
- Use only No. 26 AWG or larger telecommunication line cord.

Note(s)

- Patient movements may generate excessive noise that may affect the quality of the ECG traces and the proper analysis performed by the device.
- Proper patient preparation is important to proper application of ECG electrodes and operation of the device.
- The algorithm detecting electrode misplacements is based on normal physiology and ECG lead order, and tries to identify the most likely switch; however, it is advisable to check the other electrode positions in the same group (limb or chest).
- There is no known safety hazard if other equipment, such as pacemakers or other stimulators, is used simultaneously with the device; however, disturbance to the signal may occur.
- If electrode is not properly connected to the patient, or one or more of the patient cable lead wires is damaged, display will indicate a lead fault for the lead(s) where the condition is present by presenting a square wave and if the signal is being printed, the respective lead(s) will print out as a flat line.
- As defined by IEC 60601-1 and IEC 60601-2-25, the device is classified as follows:
 - Class I equipment or internally powered.
 - Type CF defibrillation-proof applied parts.
 - Ordinary equipment.
 - Equipment not suitable for use in the presence of a flammable anesthetic mixture.
 - Continuous operation.

***NOTE:** From a safety perspective, per IEC 60601-1 and derivative standards/norms, this device is declared to be “Class I” and uses a three-prong inlet to ensure an earth connection is made along with mains. The ground terminal on the mains inlet is the only protective earth point in the device. Exposed metal accessible during normal operation is double insulated from mains. Internal connections to earth ground are functional earth.*

- This device is intended to be used in a hospital or doctor’s office setting, and should be used and stored according to the environmental conditions specified below:

Operating temperature: +10° to +40°C (+50° to +104°F)
 Operating humidity: 10% to 95% RH, non-condensing

Storage temperature: -40° to +70°C (-40° to +158°F)
 Storage humidity: 10% to 95% RH, non-condensing

Atmospheric pressure: 500 hPa to 1060 hPa

- WAM™ (wireless acquisition module) must be paired to electrocardiograph before operation.
- Device must be configured at the factory for use with the WAM.
- After operating the device using battery power, always reconnect the power cord. This ensures that the batteries will be automatically recharged for the next time you use the device.

- The device is UL classified:



WITH RESPECT TO ELECTRIC SHOCK, FIRE AND MECHANICAL HAZARDS ONLY IN ACCORDANCE WITH UL60601-1, IEC60601-1, CAN/CSA C22.2 No. 60601-1, IEC 60601-1-1, CAN/CSA C22.2 No. 60601-1-1-02, IEC60601-2-25 AND CAN/CSA C22.2 No. 601.2.25-94.

- The device is a member of the ELI 1xx or ELI 2xx Series 2 electrocardiograph family.

Wireless Data Transmission

- Some Welch Allyn electrocardiographs can be equipped with an optional wireless data transmission module (WLAN or GSM/GPRS mobile). Both these technologies use radios to transmit data to a Welch Allyn receiving application. Due to the nature of radio transmissions, it's possible that, due to the characteristics of the environment where the device is located, some other RF sources may interfere with the transmission generated by the device. Welch Allyn has tested the coexistence of the device with other devices that can interfere such as devices using WLAN, Bluetooth radio, and/or cell phones. Although the current technology allows a very successful rate of transmission, it's possible that in some rare occurrences, the system may not perform at its best resulting in a "failed transmission." When this occurs, patient data will not be erased from the device nor stored in the receiving application, ensuring that partial or corrupted data are not made available to the receiving station. If the failure mode persists the user should move to a position where the RF signals may propagate better and allow successful transmissions.

WLAN Option

- Wireless options transmit in the 2.4 GHz or 5ghz range. Other nearby wireless devices may cause interference. If possible, move or turn off other devices to minimize potential interference.
- The Wireless LAN module used is compliant with the IEEE 802.11 a, b, g and n standards.
- Access Points used should respect IEEE 802.11 standards as well as local Radio Frequency regulations. The device will scan the available channels and connect to the Access Point on the channel where the SSID that is configured on the device is available.

- The following table shows the radio channels allocated in different geographic areas in the world. For bands 802.11b and g, only channels 1, 6, 11 and 14 (Japan only) are non-overlapping; for band 802-11a, channels shown represent non-overlapping channel numbers.

Band	Typical Power	Region	Frequency Range (GHz)	No. of channels	Channel numbers
802.11b	15 dBm / 32 mW	USA/Canada	2.401 - 2.473	11	1 – 11
		Europe	2.401 - 2.483	13	1 – 13
		Japan	2.401 - 2.495	14	1 – 14
802.11g	13 dBm / 18 mW	USA/Canada	2.401 - 2.473	11	1 – 11
		Europe	2.401 - 2.483	13	1 – 13
		Japan	2.401 - 2.483	13	1 – 13
802.11a	17 dBm / 50 mW	USA/Canada	5.15 - 5.35, 5.725 - 5.825	13	36,40,44,48,52,56,60,64,149, 153,157,161,165
		Europe	5.15 - 5.35, 5.47 - 5.725	19	36,40,44,48,52,56,60,64,100, 104,108,112,116,120,124, 128,132,136,140
		Japan	4.91 – 4.99, 5.15 - 5.35, 5.47 - 5.725	23	36,40,44,48,52,56,60,64,100, 104,108,112,116,120,124, 128,132,136,140,184,188, 192,196
		China	5.725 - 5.825	5	149,153,157,161,165











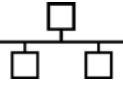

- The following table lists the frequency allocated for each channel used by the WLAN option.

Channel	Center Frequency	Frequency Spread
1	2412 MHz	2399.5 MHz - 2424.5 MHz
2	2417 MHz	2404.5 MHz - 2429.5 MHz
3	2422 MHz	2409.5 MHz - 2434.5 MHz
4	2427 MHz	2414.5 MHz - 2439.5 MHz
5	2432 MHz	2419.5 MHz - 2444.5 MHz
6	2437 MHz	2424.5 MHz - 2449.5 MHz
7	2442 MHz	2429.5 MHz - 2454.5 MHz
8	2447 MHz	2434.5 MHz - 2459.5 MHz
9	2452 MHz	2439.5 MHz - 2464.5 MHz
10	2457 MHz	2444.5 MHz - 2469.5 MHz
11	2462 MHz	2449.5 MHz - 2474.5 MHz
12	2467 MHz	2454.5 MHz - 2479.5 MHz
13	2472 MHz	2459.5 MHz - 2484.5 MHz
14	2484 MHz	2471.5 MHz - 2496.5 MHz

- In order to achieve the best transmission rate, it is necessary that the facility where the device is operated can provide good area coverage. Please consult the IT personnel of the facility to verify the proper WLAN availability in the area where the device will be used.
- RF wave propagation may be blocked or reduced by the environment where the device is used. Most common areas where this may occur are: shielded rooms, elevators, underground rooms. In all the above situations, it is recommended to move the device to a proper location and verify with the IT personnel of the facility the areas where the WLAN signals are available.

EQUIPMENT SYMBOLS AND MARKINGS

Symbol Delineation

	CAUTION The caution statements in this manual identify conditions or practices that could result in damage to the equipment or other property, or loss of data.
	WARNING The warning statements in this manual identify conditions or practices that could lead to illness, injury, or death. In addition, when used on a patient applied part, this symbol indicates defibrillation protection is in the cables. Warning symbols will appear with a grey background in a black and white document.
	Alternating current
	Protective earth
	Telephone line (modem)
	Network (LAN)
	Defibrillator-proof type CF applied part
	USB port
	Input
	ON/OFF (power)
	Stop (of action)
	Shift key (to enter upper case text)
	Enter key (accept data/return)

	Initiate printing of 12-lead ECG
	Initiate printing of continuous rhythm strip
	Transmit, receive and time sync operation depending upon configuration settings
	Do not dispose as unsorted municipal waste. Requires separate handling for waste disposal according to local requirements.
	Antenna
	Indicates compliance to applicable European Union directives
	Follow instructions/directions for use (DFU) – mandatory action. A copy of the DFU is available on this website. A printed copy of the DFU can be ordered from Welch Allyn for delivery within 7 calendar days.
	Medical Device
	Model Identifier
	Reorder Number
	Non-ionizing electromagnetic radiation

ELECTROMAGNETIC COMPATIBILITY (EMC)

Electromagnetic compatibility with surrounding devices should be assessed when using the device.

An electronic device can either generate or receive electromagnetic interference. Testing for electromagnetic compatibility (EMC) has been performed on the device according to the international standard for EMC for medical devices (IEC 60601-1-2). This IEC standard has been adopted in Europe as the European Norm (EN 60601-1-2).

The device should not be used adjacent to, or stacked on top of other equipment. If the device must be used adjacent to or stacked on top of other equipment, verify that the device operates in an acceptable manner in the configuration in which it will be used.

Fixed, portable, and mobile radio frequency communications equipment can affect the performance of medical equipment. See the appropriate table for recommended separation distances between the radio equipment and the device.

The use of accessories, transducers, and cables other than those specified by Welch Allyn may result in increased emissions or decreased immunity of the equipment.

Guidance and Manufacturer's Declaration: Electromagnetic Emissions

The equipment is intended for use in the electromagnetic environment specified in the table below. The customer or the user of the equipment should ensure that it is used in such an environment.

Emissions Test	Compliance	Electromagnetic Environment: Guidance
RF Emissions CISPR 11	Group 1	The equipment uses RF energy only for its internal function. Therefore, its RF emissions are very low and not likely to cause any interference in nearby electronic equipment.
RF Emissions CISPR 11	Class A	The equipment is suitable for use in all establishments other than domestic and those directly connected to the public low-voltage power supply network that supplies buildings used for domestic purposes.
Harmonic Emissions IEC 61000-3-2	Complies	
Voltage Fluctuations/ Flicker Emissions IEC 61000-3-3	Complies	

Guidance and Manufacturer's Declaration: Electromagnetic Immunity

The equipment is intended for use in the electromagnetic environment specified in the table below. The customer or the user of the equipment should ensure that it is used in such an environment.

Emissions Test	Compliance	Compliance Level	Electromagnetic Environment: Guidance
Electrostatic discharge (ESD) IEC 61000-4-2	+/- 6 kV contact +/- 8 kV air	+/- 6 kV contact +/- 8 kV air	Floors should be wood, concrete, or ceramic tile. If floors are covered with synthetic material, the relative humidity should be at least 30%.
Electrical fast transient/burst IEC 61000-4-4	+/- 2 kV for power supply lines +/- 1 kV for input/output lines	+/- 2 kV for power supply lines +/- 1 kV for input/output lines	Mains power quality should be that of a typical commercial or hospital environment.
Surge IEC 61000-4-5	+/- 1 kV differential mode +/- 2 kV common mode	+/- 1 kV differential mode +/- 2 kV common mode	Mains power quality should be that of a typical commercial or hospital environment.
Voltage dips, short interruptions, and voltage variations on power supply input lines IEC 61000-4-11	<5% UT (>95% dip in UT) for 0.5 cycle 40% UT (60% dip in UT) for 5 cycles	<5% UT (>95% dip in UT) for 0.5 cycle 40% UT (60% dip in UT) for 5 cycles	Mains power quality should be that of a typical commercial or hospital environment.
Power frequency (50/60 Hz) magnetic field	3 A/m	3 A/m	Power frequency magnetic fields should be at levels characteristic of a typical location in a typical commercial or hospital environment.

NOTE: UT is the AC Mains voltage prior to application of the test level.

Guidance and Manufacturer's Declaration: Electromagnetic Immunity

The equipment is intended for use in the electromagnetic environment specified in the table below. The customer or the user of the equipment should ensure that it is used in such an environment.

Emissions Test	IEC 60601 Test Level	Compliance Level	Electromagnetic Environment: Guidance
Conducted RF IEC 61000-4-6	3 Vrms 150 kHz to 80 MHz	3 Vrms 150 kHz to 80 MHz	<p>Portable and mobile RF communications equipment should be used no closer to any part of the equipment, including cables, than the recommended separation distance calculated from the equation applicable to the frequency of the transmitter.</p> <p>Recommended separation distance</p> $d = \left[\frac{3.5}{3V_{rms}} \right] \sqrt{P}$ $d = \left[\frac{3.5}{3V/m} \right] \sqrt{P} \quad 80 \text{ MHz to } 800 \text{ MHz}$ $d = \left[\frac{7}{3V/m} \right] \sqrt{P} \quad 800 \text{ MHz to } 2.5 \text{ GHz}$ <p>Where P is the maximum output power rating of the transmitter in watts (W) according to the transmitter manufacturer and d is the recommended separation distance in meters (m).</p> <p>Field strengths from fixed RF transmitters, as determined by an electromagnetic site survey^a, should be less than the compliance level in each frequency range^b.</p> <p>Interference may occur in the vicinity of equipment marked with the following symbol:</p> 
Radiated RF IEC 61000-4-3	3 V/m 80 MHz to 2.5 GHz	3 V/m 80 MHz to 2.5 GHz	

- a. Field strengths from fixed transmitters, such as base stations for radio (cellular/cordless) telephones and land mobile radios, amateur radios, AM and FM radio broadcast, and TV broadcast cannot be predicted theoretically with accuracy. To assess the electromagnetic environment due to fixed RF transmitters, an electromagnetic site survey should be considered. If the measured field strength in the location in which the equipment is used exceeds the applicable RF compliance level above, the equipment should be observed to verify normal operation. If abnormal performance is observed, additional measures may be necessary, such as reorienting or relocating the equipment.
- b. Over the frequency range 150 kHz to 80 MHz, field strengths should be less than [3] V/m.

Recommended Separation Distances Between Portable and Mobile RF Communications Equipment and the Equipment

The equipment is intended for use in the electromagnetic environment in which radiated RF disturbances are controlled. The customer or the user of the equipment can help to prevent electromagnetic interference by maintaining a minimum distance between portable and mobile RF communications equipment (transmitters) and the equipment as recommended in the table below, according to the maximum output power of the communications equipment.

Rated Maximum Output Power of Transmitter W	Separation Distance According to Frequency of Transmitter (m)	
	150 KHz to 800 MHz	800 MHz to 2.5 GHz
	$d = 1.2\sqrt{P}$	$d = 2.3\sqrt{P}$
0.01	0.1 m	0.2 m
0.1	0.4 m	0.7 m
1	1.2 m	2.3 m
10	4.0 m	7.0 m
100	12.0 m	23.0 m

For transmitters rated at a maximum output power not listed above, the recommended separation distance d in meters (m) can be estimated using the equation applicable to the frequency of the transmitter, where P is the maximum output power rating of the transmitter in watts (W) according to the transmitter manufacturer.

NOTE 1: At 800 MHz, the separation distance for the higher frequency range applies.

NOTE 2: These guidelines may not apply in all situations. Electromagnetic propagation is affected by the absorption and reflection from structures, objects, and people.

Regulatory Radio Compliance

Federal Communications Commission (FCC)

This device complies with part 15 of the FCC Rules. Operation is subject to the following two conditions:

- This device may not cause harmful interference.
- This device must accept any interference received, including interference that may cause undesired operation.

This equipment has been tested and found to comply with the limits for a Class B digital device, pursuant to Part 15 of FCC Rules. These limits are designed to provide reasonable protection against harmful interference in a residential installation. This equipment generates, uses, and can radiate radio frequency energy. If not installed and used in accordance with the instructions, it may cause harmful interference to radio communications. However, there is no guarantee that interference will not occur in a particular installation. If this equipment does cause harmful interference to radio or television reception, which can be determined by turning the equipment off and on, the user is encouraged to try and correct the interference by one or more of the following measures:

- Reorient or relocate the receiving antenna
- Increase the distance between the equipment and the receiver
- Connect the equipment to an outlet on a circuit different from that to which the receiver is connected
- Consult the dealer or an experienced radio/TV technician for help

The user may find the following booklet prepared by the Federal Communications Commission helpful: The Interference Handbook This booklet is available from the U.S. Government Printing Office, Washington, D.C. 20402. Stock No. 004-000-0034504. Welch Allyn is not responsible for any radio or television interference caused by unauthorized modification of the devices included with this Welch Allyn product, or the substitution or attachment of connecting cables and equipment other than specified by Welch Allyn. The correction of interference caused by such unauthorized modification, substitution, or attachment will be the responsibility of the user.

WLAN
B&B electronics ¹ Radio Module 9373 with part number WLNN-AN-MR551 FCC ID: F4AWLNN551
¹ Manufacturer also called B+B SmartWorx

Industry Canada (IC) Emissions

RF Radiation Hazard Warning

Using higher gain antennas and types of antennas not certified for use with this product is not allowed. The device shall not be co-located with another transmitter.

Cet avertissement de sécurité est conforme aux limites d'exposition définies par la norme CNR-102 at relative aux fréquences radio.

This device complies with RSS 210 of Industry Canada.

Operation is subject to the following two conditions: (1) this device may not cause interference, and (2) this device must accept any interference, including interference that may cause undesired operation of this device.

L'utilisation de ce dispositif est autorisée seulement aux conditions suivantes: (1) il ne doit pas produire de brouillage et (2) l'utilisateur du dispositif doit être prêt à accepter tout brouillage radioélectrique reçu, même si ce brouillage est susceptible de compromettre le fonctionnement du dispositif.

This Class B digital apparatus complies with Canadian ICES-003.

Cet appareil numérique de la classe B est conform à la norme NMB-003 du Canada.

WLAN
B&B electronics ¹ Radio Module 9373 with part number WLNN-AN-MR551 IC ID: 3913A-WLNN551
¹ Manufacturer also called B+B SmartWorx

Declaración de conformidad Mexico

La operación de este equipo está sujeta a las siguientes dos condiciones:



1. es posible que este equipo o dispositivo no cause interferencia perjudicial y
2. este equipo o dispositivo debe aceptar cualquier interferencia, incluyendo la que pueda causar su operación no deseada.

European Union

Czech	Welch Allyn tímto prohlašuje, že tento WLAN device je ve shodě se základními požadavky a dalšími příslušnými ustanoveními směrnice 2014/53/ES.
Danish	Undertegnede Welch Allyn erklærer herved, at følgende udstyr WLAN device overholder de væsentlige krav og øvrige relevante krav i direktiv 2014/53/EF
Dutch	Bij deze verklaart Welch Allyn dat deze WLAN device voldoet aan de essentiële eisen en aan de overige relevante bepalingen van Richtlijn 2014/53/EC.
English	Hereby, Welch Allyn, declares that this WLAN device is in compliance with the essential requirements and other relevant provisions of Directive 2014/53/EC.
Estonian	Käesolevaga kinnitab Welch Allyn seadme WLAN device vastavust direktiivi 2014/53/EÜ põhinõuetele ja nimetatud direktiivist tulenevatele teistele asjakohastele sätetele.
Finnish	Welch Allyn vakuuttaa täten että WLAN device tyyppinen laite on direktiivin 2014/53/EY oleellisten vaatimusten ja sitä koskevien direktiivin muiden ehtojen mukainen.
French	Par la présente, Welch Allyn déclare que ce WLAN device est conforme aux exigences essentielles et aux autres dispositions de la directive 2014/53/CE qui lui sont applicables
German	Hiermit erklärt Welch Allyn die Übereinstimmung des Gerätes WLAN device mit den grundlegenden Anforderungen und den anderen relevanten Festlegungen der Richtlinie 2014/53/EG. (Wien)
Greek	ΜΕ ΤΗΝ ΠΑΡΟΥΣΑ Welch Allyn ΔΗΛΩΝΕΙ ΟΤΙ WLAN device ΣΥΜΜΟΡΦΩΝΕΤΑΙ ΠΡΟΣ ΤΙΣ ΟΥΣΙΩΔΕΙΣ ΑΠΑΙΤΗΣΕΙΣ ΚΑΙ ΤΙΣ ΛΟΙΠΕΣ ΣΧΕΤΙΚΕΣ ΔΙΑΤΑΞΕΙΣ ΤΗΣ ΟΔΗΓΙΑΣ 2014/53/ΕΚ
Hungarian	Alulírott, Welch Allyn nyilatkozom, hogy a WLAN device megfelel a vonatkozó alapvető követelményeknek és az 2014/53/EC irányelv egyéb előírásainak.
Italian	Con la presente Welch Allyn dichiara che questo WLAN device è conforme ai requisiti essenziali ed alle altre disposizioni pertinenti stabilite dalla direttiva 2014/53/CE.
Latvian	Ar šo Welch Allyn deklarē, ka WLAN device atbilst Direktīvas 2014/53/EK būtiskajām prasībām un citiem ar to saistītajiem noteikumiem.
Lithuanian	Šiuo Welch Allyn deklaruoja, kad šis WLAN device atitinka esminius reikalavimus ir kitas 2014/53/EB Direktyvos nuostatas.
Malti	Hawnhekk, Welch Allyn, jiddikjara li dan WLAN device jikkonforma mal-htigijiet essenzjali u ma provvedimenti oħrajn relevanti li hemm fid-Direttiva 2014/53/EC
Portuguese	Welch Allyn declara que este WLAN device está conforme com os requisitos essenciais e outras disposições da Directiva 2014/53/CE.
Slovak	Welch Allyn týmto vyhlasuje, že WLAN device spĺňa základné požiadavky a všetky príslušné ustanovenia Smernice 2014/53/ES.
Slovene	Šiuo Welch Allyn deklaruoja, kad šis WLAN device atitinka esminius reikalavimus ir kitas 2014/53/EB Direktyvos nuostatas.
Spanish	Por medio de la presente Welch Allyn declara que el WLAN device cumple con los requisitos esenciales y cualesquiera otras disposiciones aplicables o exigibles de la Directiva 2014/53/CE
Swedish	Härmed intygar Welch Allyn att denna WLAN device står i överensstämmelse med de väsentliga egenskapskrav och övriga relevanta bestämmelser som framgår av direktiv 2014/53/EG.

Radio Compliance Table

Argentina	Ente Nacional de las Comunicaciones (ENACOM)	 COMISIÓN NACIONAL DE COMUNICACIONES C-22663 (B&B)	
Australia	Australian Communications and Media Authority (ACMA) Radio Compliance Mark (RCM).		
Brazil	Agência Nacional de Telecomunicações (ANATEL)	 Modelo: B&B 02432-19-10488	Este produto contém a placa 9373 código de homologação ANATEL B&B: 02432-19-10488. Este equipamento não tem direito à proteção contra interferência prejudicial e não pode causar interferência em sistemas devidamente autorizados
EAC			Products meet all requirements of the corresponding technical regulations and have passed all conformity assessment procedures.
Indonesia		Keterangan a. [61733/I/SDPPI/2019] (B&B) adalah nomor sertifikat yang diterbitkan untuk setiap alat dan perangkat telekomunikasi b. [8620] (B&B) adalah nomor PLG ID (identitas pelanggan) berdasarkan database Lembaga Sertifikasi	Identification a. [61733/I/SDPPI/2019] (B&B) is a number of certificate issued for certified telecommunication equipment b. [8620] (B&B) is a number of PLG ID based on one Certification Body database
Mexico	Instituto Federal de Telecomunicaciones (Federal Telecommunications Institute—IFETEL)	This product contains and Approved module, Model No. 9373, IFETEL No. RCPBB9319-0533 (B&B)	
Morocco			AUTHORIZED BY MOROCCO ANRT B&B: Approval number: MR 17490 ANRT 2018 Date of approval: 13-SEP-2018
Oman	Telecommunications Regulatory Authority		B&B R/6162/18 D172249
Paraguay	Comisión Nacional de Telecomunicaciones		NR: 125/2019
Pakistan	Pakistan Telecom Authority		

Philippines	National Telecommunications Commission		B&B: ESD - 1818097C
Singapore	Info-Communications Media Development Authority (IMDA)		
South Korea	Korea Communications Commission (대한민국 방송통신위원회) – KCC Certification number: B&B: R-C-BVT-9373		This equipment is Industrial (Class A) electromagnetic wave suitability equipment and seller or user should take notice of it, and this equipment is to be used in the places except for home. 이 기 기 는 업 무 용 (A 급) 전 자 파 적 합 기 기 로 서 판 매 자 또는 사용자는 이 점을 주의하시기 바라 며, 가정 외 의 지 역 에 서 사 용 하 는 것 을 목 적 으 로 합 니 다. Class A Equipment (Industrial Broadcasting & Communication Equipment) A 급 기 기 (업 무 용 방 송 통 신 기 자 재)
UAE			B&B ER65768/18

MAINTENANCE & CLEANING

Recommended Tools and Supplies

Device Cleaning / Consumables:

- Clean lint free cloth
- Mild detergent
- Isopropyl Alcohol (80-99%)
- Cyanoacrylate Adhesive (e.g., Loctite 444 or equivalent product)
- Anaerobic Thread locker
- Smart Thermal Paper
- 10% Household bleach and water solution (Sodium Hypochlorite solution consisting of a minimum 1:500 dilution and maximum of 1:10 dilution for disinfecting use only)

Preventive Maintenance / Conformance Testing

- Multi-Meter
- ECG Simulator (10 Lead)
- AM12 Patient Input Module (9293-048-5X)
- WAM Patient Input Module (30012-019-5X)
- WAM/AM12 Lead Wire Set (9293-046-70)
- Patient Cable Snap Adapter Set (9281-002-50)
- Phillips #2 Screwdriver
- 10 Lead Shorting Block (or equivalent)
- Lead Test Failure Box (or equivalent)
- FAT 32 USB Memory Device
- PC with ELI-Link v3.10 or later
- USB Cable Type A to B (6400-012)
- Phone Cable (6400-004)
- PC with ELI-Link or Escribe and Modem (or equivalent)
- PC with NIC and ELI-Link v4.5 or later
- Wireless Router 802.11 (a, b, g, n)
- Electrical Safety Analyzer

Preventive Maintenance

Preventive maintenance is recommended to be performed on the ELI150c/250c once every 12 months.



WARNING: Preventive maintenance is to be performed by Welch Allyn authorized service personnel only.

2.0 Maintenance Procedure

- 2.1 Turn unit on and print the device configuration per configuration section of this manual. Attach a copy to the Preventive Maintenance Report.
- 2.2 Remove the unit cover.
- 2.3 Perform a visual inspection of the following items:
 - 2.3.1 Enclosure/Housing – Look for damage or cracks in the external housing or enclosure that could possibly expose the device to the introduction of foreign objects or fluids. Attention should also be paid to areas that could expose an operator or patient to internal circuitry of the device.
 - 2.3.2 Contamination – Look for any contamination that may have occurred over time that could not be seen with the housing in place.
 - Fluid damage (perhaps caused during device cleaning)
 - Debris on or behind display shield
 - Battery leakage (lithium and main battery)
 - 2.3.3 Internal Cabling – Look for cracked, pinched or partially disconnected cable connections.
 - 2.3.4 Fuse Ratings – Verify PCB mounted fuses (items 23 and 24) the meet the specifications defined in the item description listing.
 - 2.3.5 Markings and Labeling – Verify all labels and device markings are clearly visible and legible to the device user and have not been worn off or rendered unreadable through the use of harsh cleaning agents.
 - 2.3.6 Integrity of Mechanical Parts – Verify the following items are properly secured to the device and have not become loose or damaged through usage over time.
 - AC Inlet
 - Patient Input Connector
 - Communication ports and antenna
 - Writer mechanics/latching mechanism

2.4 Power Testing

* Based upon customer usage and age of battery, replace as needed.

- 2.4.1 Ensure battery is fully charged before performing these tests, voltage and current limits are based on a fully charged battery.
- 2.4.2 Ensure there is no power connected to the UUT AC inlet.
- 2.4.3 Remove upper housing and writer assembly. Disconnect battery by pulling battery cable off of the red terminal.

- 2.4.4 **Note battery age** (if possible)
This information can be found on the white “date code” sticker located on the battery (use the earliest date that is not crossed out). Record date on Preventative Maintenance Report (PMR).
 - 2.4.5 **Battery (open circuit)**
Measure battery voltage using a voltage meter; verify the meter reads greater than 12.5vdc. Record result on PMR.
 - 2.4.6 **Battery (load)**
Measure the battery voltage using a volt meter and a power resistor load (10ohm, 20watt) in parallel with the battery. After approximately 5 seconds, verify the meter reads greater than 11.7vdc. Record result on PMR.
 - 2.4.7 **Off current**
Connect a current meter in line with battery. With the UUT power off, verify the current meter reads less than 100 micro amps. Record result on PMR.
 - 2.4.8 **On current**
Turn on the unit and verify the current meter reads less than 250 milli amps. Record result on PMR.
 - 2.4.9 **AC charging current**
Apply AC power to the unit and verify that the current draw from the battery reverses polarity and the value starts decreasing as time increases. Record result on PMR.
 - 2.4.10 **Battery charger output voltage**
Disconnect the current meter and measure the battery charger output voltage between the red disconnected battery cable and the negative terminal on the battery. It should read between 13.0vdc and 14.0vdc. Record result on PMR.
- 2.5 Verify all power cables are reconnected properly
- 2.6 Reassemble unit in reverse order of disassembly
- 2.7 Functional Testing
- 2.7.1 **AC LED/Display**
Connect AC power cord to the unit and verify that the green AC LED (located to the left of the display) illuminates continuous.
NOTE: The battery indicator will be clear when charging and will illuminate white when fully charged.
Verify text on display is clear and legible and there are no flickering or missing lines/pixels. Record result on PMR.
 - 2.7.2 **Writer**
Open and close the writer door to verify smooth operation. Verify that the door unlatches without sticking and that it latches completely. From the main screen, simultaneously press shift+alt+RHY. Verify that a test page is printed and the writer stops on the cue mark. The perforation of the paper should line up with the tear edge on the writer. Assure there are no gaps in the printing and the print darkness is uniform across the entire page. Verify the writer gears do not skip and paper is tracking properly (you may need to print multiple pages to observe this). Record result on PMR.

2.7.3 ECG & Keyboard Matrix

Connect an ECG simulator to the AM12 or WAM patient interface. Set the simulator to a known heart rate and amplitude. Press the ECG key to capture an ECG. Verify there is an audible beep with each key press. Enter Last name "PARCFL8" (Note: "PARCFL8" ensures the keyboard matrix is fully tested), then press F6 (Done). Verify that 12 ECG traces print correctly and assess the printout quality. Ensure uniform darkness across entire printout. Record result on PMR.

2.7.4 ECG Noise Test

Connect a Shorting Block (TF-0629-*) and adapter or equivalent to the AM12 or WAM patient interface. Set the ECG gain on the unit to 20mm/mV. Print a rhythm strip (approx. 1 page). Verify that no channels have more than 0.5mm of noise as measured by using Welch Allyn thermal paper. (Smallest grid line = 1mm) Record result on PMR

2.7.5 Communication Option Testing (as applicable)

The receiving station for modem, LAN and WLAN transmissions should be running Welch Allyn ELI-Link software. Refer to the ELI-Link user manual for proper configuration.

Verify successful transmission of all applicable communication options by acquiring ECG records that include the transmission method in the "Patient Name" field (such as Last Name = USBD) then subsequently transmitting the ECG record stored to a compatible receiving device. Consult the product user manual if needed to properly configure the communication settings for each option present on the unit under test.

Successful transmission of the test records can be verified by viewing the ECG records in the unit directory after transmission and confirming they are marked as "transmitted" (as defined in the product user manual). Record result on PMR

- Modem
- LAN
- WLAN
- GSM/GPRS
- USB host (USB memory device needed)
- USBD

2.8 Clean unit per the instructions provided on a later page of this section of the service manual.

2.9 Safety Testing

If the cardiograph housing was opened for repair or inspection work, the following safety tests should be performed in accordance with the IEC 60601 standards.

The ELI150C and ELI250C are considered a Class 1 Type CF devices, intended to only be utilized with the Welch Allyn AM12 or WAM patient input modules. Defibrillation isolation from the patient is provided by the patient input modules, which are tested separately as part of the manufacturing process (they are considered non-serviceable devices), therefore Hi-pot testing is not required for these cardiograph models.

- Earth Leakage
- Enclosure Leakage
 - Non-conductive (fully insulated) chassis testing should be performed utilizing 200 cm² conductive foil or equivalent, earth ground on AC input is utilized for functional earth (not safety grounding).
- Patient Leakage
 - Applied part – patient input (utilize Welch Allyn AM12 patient cable)
- Patient Auxiliary Current
 - Applied part – patient input (utilize Welch Allyn AM12 patient cable)

Device Cleaning & Disinfecting

1. Disconnect the power source. Remove cables and lead wires from device before cleaning.
2. For general cleaning of cables and lead wires, use a soft, lint-free cloth lightly moistened with a mild soap and water solution. Wipe and air dry.
3. For disinfecting the exterior surfaces of the device, patient acquisition module, cables, and lead wires, wipe exterior using:

Clorox Healthcare® Bleach Germicidal Wipes (use according to instructions on product label), *or*

a soft, lint-free cloth with a solution of Sodium Hypochlorite (10% household bleach and water solution) minimum 1:500 dilution (minimum 100 ppm free chlorine) and maximum 1:10 dilution as recommended by the APIC Guidelines for Selection and Use of Disinfectants



CAUTION:

Prevent liquid from penetrating the device and do not attempt to clean/disinfect the device or patient cables by submerging into a liquid, autoclaving, or steam cleaning.

Do not expose cables to strong ultra-violet radiation.

Do not sterilize the device or lead wires with Ethylene Oxide (EtO) gas.

Do not immerse cable ends or lead wires; immersion can cause metal corrosion. Use caution with excess liquid as contact with metal parts may cause corrosion.

Do not use excessive drying techniques such as forced heat.

Improper cleaning products and processes can damage the device, produce brittle lead wires and cables, corrode the metal, and void the warranty. Use care and proper procedure whenever cleaning or maintaining the device.

ELI 150/250c Preventive Maintenance Report

Unit Serial #: _____

- Print device configuration (attach to this report)
- Remove the units upper housing

Perform Visual Inspection PASS / FAIL

Power Testing

Note Battery Age (If Possible) _____ / _____ (week/year)
 Battery (Open Circuit) Voltage _____ VDC (>12.5vdc)
 Battery (with Load) Voltage _____ VDC (>11.7vdc)
 Off Current _____ Ua (<100uA)
 On Current _____ mA (<250mA)

AC Charging Current PASS / FAIL (Circle One)

Battery Charger Output Voltage _____ VDC (13.0-14.0vdc)

* Based upon customer usage and age of main battery, replace as needed.

- Verify all power cables are properly reconnected and reassemble unit

Functional testing

AC LED/Display Functionality PASS / FAIL (Circle One)
 Writer Test PASS / FAIL (Circle One)
 ECG & Keyboard Matrix Testing PASS / FAIL (Circle One)
 ECG Noise Test PASS / FAIL (Circle One)
 Lead failure Test PASS / FAIL (Circle One)
 Communication Option(s)
 USB host PASS / FAIL/ NA (Circle One)
 USB PASS / FAIL/ NA (Circle One)
 MODEM PASS / FAIL/ NA (Circle One)
 GSM/GPRS PASS / FAIL/ NA (Circle One)
 LAN PASS / FAIL/ NA (Circle One)
 WLAN PASS / FAIL/ NA (Circle One)

- Device Cleaning

Safety Testing PASS / FAIL (Circle One)

Earth Leakage
 Enclosure Leakage
 Patient Leakage
 Patient Leakage Current

Performed by: _____ Date: _____ / _____ / _____

DEVICE CONFIGURATION

Setting Technician Password

1. From real-time ECG view, select **F6 (More)** followed by **F5 (Set Time/Date)**.
2. While holding down **↑ (SHIFT)**, depress **ALT** and **P** simultaneously.
3. If required, enter password. This will automatically advance you to the set passwords display.

NOTE: The factory default password is “admin” (lowercase, no quotation marks); it is suggested that the password be changed after installation of the unit.

4. Enter a technician password followed by a second entry to confirm.

NOTE: Password is case sensitive and alphanumeric.

5. From this display, select **F6 (Exit)** to return to real-time ECG view.

Configuration Menus

The configuration pages define all operational conditions that do not change on a daily or patient-to-patient basis. Once you set these default conditions, you will rarely need to use the configuration screens again. To access the configuration menus:

1. From real-time ECG view, select **F6 (More)** followed by **F5 (Set Time/Date)**.
2. While holding down **↑ (SHIFT)**, depress **ALT** and **C** simultaneously.
3. If required, enter password. The first configuration screen will appear. Notice the page indicator in the upper right-hand corner.

To navigate the configuration menus:

- Use **F4 (Page)** to toggle through the configuration pages.
- Use **F1 (▲)** and **F2 (▼)** to move back and forth through each configuration option.
- Use **F3 (▶)** to toggle through pre-programmed available settings per configuration field.
- Use **F6 (Exit)** to return to real-time ECG view. Any changes you have made will be saved.
- Use **BKSP** to erase entry errors.

To print the device's configuration settings, select **F6 (More)** from real-time ECG view. Select **F6 (More)** again followed by **F1 (Print Configuration)**. The configuration printout captures every configuration setting: the software version, the cart number of the device, and the date and time that the configuration printout occurred.

Summary of Configuration Menus

Configuration Parameter	Definition
Software Version	Displays software version on printout and display
Cart Number	Numeric field 0 to 65535
Site Number	Numeric field 0 to 4095
Site Name	Alphanumerical field (30 digits)
Telephone Number	Alphanumerical field (45 digits)
Language	Available software languages
Volume	Numerical field 0 to 8
Battery Timeout	10 min, 30 min, 60 min
Flash Size	Normal or expanded (optional)
ID Format	Standard, Short, Long, Custom
Auto-Fill ID	YES/NO
AC Filter	50 Hz, 60 Hz, None
Paper Speed	25 or 50 mm/sec
Filter	Frequency response for printouts: 40 Hz, 150 Hz, 300 Hz
Height/Weight Units	lb/in or kg/cm
Date Format	US (mm/dd/yyyy) or European (dd.mm.yyyy)
Interpretation	YES/NO
Reasons	YES/NO
Append	Unconfirmed Report, Reviewed by
# of Copies	0 – 9
Copies with Interp.	YES/NO
# ECGs Retrieved	0 – 7
Delete Rule	Post Plot, Post Transmit, Post Plot/Xmt
Storage Sensitivity	Normal or High
Auto-Save ECG	YES/NO
Auto-Print ECG	YES/NO
Cap Lock	YES/NO
Use A4 paper (ELI 250c only)	YES/NO
Rhythm Format	3 or 6 channel (ELI 150c); 3, 6, or 12 channel (ELI 250c)
3 Rhythm Lead 1	V1-V6, I, II, III, aVR, aVL, aVF
3 Rhythm Lead 2	V1-V6, I, II, III, aVR, aVL, aVF
3 Rhythm Lead 3	V1-V6, I, II, III, aVR, aVL, aVF
6 Rhythm Lead 1	V1-V6, I, II, III, aVR, aVL, aVF

Summary of Configuration Menus (continued)

Configuration Parameter	Definition
6 Rhythm Lead 2	V1-V6, I, II, III, aVR, aVL, aVF
6 Rhythm Lead 3	V1-V6, I, II, III, aVR, aVL, aVF
6 Rhythm Lead 4	V1-V6, I, II, III, aVR, aVL, aVF
6 Rhythm Lead 5	V1-V6, I, II, III, aVR, aVL, aVF
6 Rhythm Lead 6	V1-V6, I, II, III, aVR, aVL, aVF
Plot Format	3, 3+1, 3+3, 6 channel; Cabrera or standard (ELI 150c) 3+1, 3+3, 6, 6+6, 12 channel; Cabrera or standard (ELI 250c)
3+1 Rhythm Lead	V1-V6, I, II, III, aVR, aVL, aVF
3+3 Rhythm Lead 1	V1-V6, I, II, III, aVR, aVL, aVF
3+3 Rhythm Lead 2	V1-V6, I, II, III, aVR, aVL, aVF
3+3 Rhythm Lead 3	V1-V6, I, II, III, aVR, aVL, aVF
Bar Code Scanner	YES/NO
Avg RR	YES/NO
QTcB	YES/NO
QTcF	YES/NO
ECG Capture	Last 10 or Best 10
Band Mode (GSM/GPRS only) (ELI 150c only)	850/1900MHz (US) or 900/1800MHz(EU)
Sync Media	None, Modem, LAN, WLAN, GSM/GPRS (GSM/GPRS option applies to ELI 150c only)
DHCP (active for LAN or WLAN)	YES/NO
IP Address (active for LAN or WLAN)	XXX.XXX.XXX.XXX
Def Gateway (active for LAN or WLAN)	XXX.XXX.XXX.XXX
Sub Net Mask (active for LAN or WLAN)	XXX.XXX.XXX.XXX
Host IP (active for LAN or WLAN)	XXX.XXX.XXX.XXX
Port Number (active for LAN or WLAN)	Numeric field (9 digits)
Security	None, WEP128, WEP64, WPA-PSK, WPA-LEAP, WPA-PSK64, WPA-PSK128, WPA-LEAP 64, WPA-LEAP128, WPA2-PSK, WPA2-PEAP
LAN MAC	XX XX XX XX XX XX
WLAN MAC	XXXXXXXXXXXX
SSID	Alphanumeric field (30 digits) (not on printout)

Summary of Configuration Menus (continued)

Configuration Parameter	Definition
WEP Key	Numeric (1 digit) (not on printout); valid range 1-4
WEP Key ID	Alphanumeric field (26 digits) A-F, 0-9 (not on printout)
PSK Passphrase	Alphanumeric field (64 digits) (not on printout)
LEAP User Name	Alphanumeric field (32 digits) (not on printout)
LEAP Password	Alphanumeric field (32 digits) (not on printout)
PEAP User Name	Alphanumeric field (63 digits) (not on printout)
PEAP Password	Alphanumeric field (63 digits) (not on printout)
Worklist Management	Standard or Refresh
Comm Protocol	UNIPRO32, DICOM32, DICOM32ext OR UNIPRO64, DICOM64 (V2.x software)
Sync Mode	None, XMT, XMT+Orders
Sync Date/Time	YES/NO
XMT Mandatory Fields	None, Last Name, ID, Last Name+ID

Configuration Settings

Software Version

Identifies the software version of your electrocardiograph.

Cart Number

Indicates which electrocardiograph acquired or transmitted a particular ECG.

Site Number

Identifies the site of your device. Site numbers designate the hospital, clinic, or institution for ECG records stored in an E-Scribe system and must be defined for transmitting and retrieving ECGs from that system. You can use up to four digits for the site number. Numbers from 0 – 4095 are supported.

Site Name

Defines your clinic, hospital, or office name. You can enter up to 30 alphanumeric characters. The site name prints at the bottom, left edge of the ECG printout.

Telephone Number

Specifies the telephone number for internal modem transmission to another unit or to an E-Scribe system. Enter up to 45 numeric characters.

You may need to dial a **9** to get an outside line. To wait for an additional dial tone, use the letter **W**.

EXAMPLE: 9**W**14145554321

To insert a pause, use a comma (,).

To change tone dialing to pulse dialing, use the letter **P**.

EXAMPLE: **P**14145554321

(If necessary, you can use both the letter **W** and the letter **P** in the same phone number.)

***NOTE:** It is not necessary to use alpha characters in the telephone number with GSM/GPRS mobile connectivity.*

***TIP:** To quickly delete or modify a phone number, use a shortcut. From the application screen, simultaneously press **↑ (SHIFT) + ALT + P**. To edit an existing telephone number, use the **Tab** key.*

Language

There are several languages available on the electrocardiograph.



***CAUTION:** Function labels are immediately translated upon selecting a new language and exiting the configuration screen.*

If an unknown language is visible, use the following steps to revert to the language of your country:

1. **F6 (More)** from real-time ECG view.
2. Select **F5 (Set Time/Date)**.
3. Simultaneously press **↑ (SHIFT) + ALT + C**.
4. Enter password (“admin”)
5. Press **F2 (▼)** four times.
6. Press **F3 (▶)** until the desired language appears.
7. **F6 (Exit)** to return to real-time ECG view.

Alphabets of specific languages may require use of special characters in demographic fields. This is accomplished by using the **SYM** key on the keyboard.

Volume

Defines the keyboard click loudness. Available settings range from 0 (off) to 8 (loud).

Battery Time Out

Determines when the electrocardiograph will switch off in order to conserve the battery life of the device. The battery time out will only occur if the keyboard has not been depressed for the time specified. The battery time out setting is ignored if an active ECG signal is detected during transmission or while rhythm printing.

Flash Size

Indicates ECG storage capacity. Normal indicates standard memory capacity. Expanded indicates the optional expanded memory has been installed.

ID Format

Defines the format for the patient demographic information prompts. There are three standard formats: short, standard, or long. A custom ID format can be downloaded from ELI Link or an E-Scribe system. See Appendix A to download a custom ID.

The short format includes the patient's last and first name, patient ID number, date of birth (automatically calculates the age), and gender.

The standard format includes the patient's last name, patient ID number, age, height, weight, gender, race, medication 1, medication 2, and a location field.

The long format is identical to the standard format except that it includes the patient's first name, room, and comment fields.

Auto-Fill ID

When enabled, the device will automatically populate last name, first name, date of birth, age, and gender in the ID screen if records with matching patient ID are found in the ECG directory.

AC Filter

The device removes 60 Hz or 50 Hz interference. The setting you select depends on the line frequency in your country. Always use the 60 Hz setting in the U.S. If AC interference is present, check to see that the proper AC filter is selected.

Paper Speed

Configure to 25 mm/s or 50 mm/s for default ECG printouts. For rhythm printouts and display, speeds of 5 mm/s or 10 mm/s are also available. See Device Configuration section to change speeds for display or rhythm printing. Paper speed is printed at the bottom right corner of the ECG printout.

Filter

The ECG plot-frequency filter (or print filter) can be set to 0.05 to 40 Hz, 0.05 to 150 Hz, or 0.05 to 300 Hz. The plot-frequency filter does not filter the acquired digital record. A 40 Hz plot-filter setting will reduce the noise (40 Hz and higher frequencies) on the printed ECG, and a 150 Hz plot-filter setting will reduce the noise (150 Hz and higher frequencies) on the printout; a 300 Hz plot-filter setting will not filter the printed ECG. The filter setting is printed at the bottom right corner of the ECG printout.

Height/Weight Units

Defines the units of weight and height to either pounds/inches (lb/in) or kilograms/centimeters (kg/cm).

Date Format

Select either U.S. or European format for entering and displaying the patient's date of birth.

U.S. Date Format:	MM/DD/YYYY
European Date Format:	DD.MM.YYYY

***NOTE:** The date format option does not modify the acquisition date printed on each ECG.*

Interpretation

The device automatically analyzes ECGs and prints the optional interpretation on the ECG printout. This setting allows you to select or suppress the “interpretive” text on the ECG report.

***NOTE:** The ECG interpretations offered by the device are only significant when used in conjunction with a physician over-read as well as consideration of all other relevant patient data.*

Reasons

The reasons statements indicate why a particular interpretive statement was printed. Reasons statements print enclosed in [square brackets] within the interpretive text if the interpretation option is turned on. Turning the reasons statement function on or off does not affect the measurements performed or the interpretive statements selected by the analysis program.

For Example:

Anteroseptal Infarct [40+ ms Q WAVE IN V1-V4]

Where “Anteroseptal Infarct” is the interpretive statement,

and “40+ ms Q WAVE IN V1-V4” is the reason statement or explanation as to why the interpretive statement was printed.

Append

A status or statement phrase can be appended to the ECG and printed under the interpretive text printout. Either “unconfirmed report” or “reviewed by” can be selected.

Number of Copies

Defines the number of printed copies when an ECG is taken. (V1.x) A zero (0) setting prints the original only; one (1) prints the original plus 1 copy; two (2) prints the original plus 2 copies, and so on. Up to 9 copies may be selected. (V2.x) A zero (0) setting does not print the ECG; one (1) prints the original; two (2) prints the original plus 1 copy, and so on. Up to 9 copies may be selected.

Copies with Interpretation

Defines whether or not printed copies will include interpretation. The clinician may request the first ECG printout with the interpretation included. Additional copies may be printed with or without the interpretation.

Number of ECGs Retrieved

Defines the number of ECGs retrieved from an E-Scribe system. The ECGs are retrieved by ID number. A zero (0) setting retrieves the most current ECG for that ID number. Settings from one (1) to seven (7) retrieve the most current ECG plus “X” number of ECGs identified by the entered value. EXAMPLE: If you enter the number 5, you will retrieve the most current ECG plus the five preceding ECGs for that ID number. ECGs retrieved from the E-Scribe are only printed at the device and not saved.

Delete Rule

Defines the rule to mark ECGs as deleted in the ECG directory. ECGs that are marked for deletion will be automatically removed or erased based on their acquisition date (a first-in/first-out philosophy) to make room for the new ECG record. ECGs are only erased from the directory when they are marked for deletion and if the directory becomes full. More than one ECG may be removed from the directory in order to make room for the new incoming record. The delete rule selections are:

Post Plot = ECG is automatically marked for deletion after printing

Post Transmit = ECG is automatically marked for deletion after transmission

Post Plot/Transmit = ECG is automatically marked for deletion after transmission and printing

Storage Sensitivity

Dictates the resolution of all stored ECG records. The sensitivity setting is either Normal or High. If the value is set to High, the stored ECG will have a high resolution. As a result, the record size will be large and will reduce the storage capacity in the ECG directory.

Auto-Save ECG (V1.x only)

Defines whether or not a newly acquired ECG will be automatically saved to the directory once it is acquired and printed. If the auto-save configuration option is set to No and the record is printed, the device will prompt you to “Save ECG?” **F1 (Save)** will store the ECG in the directory.

Auto-Print ECG (V1.x only)

Defines whether or not the device will automatically print the ECG after acquisition. If the selected configuration option is set to No, a manual printout is possible.

Caps Lock

All character entry is translated to uppercase.

Use A4 Paper

The ELI 250c accommodates use of Z-fold thermal paper in either letter size (8.5 x 11 inches; 216 x 279 mm) or A4 size (8.27 x 11.69 inches; 210 x 297 mm). The provided paper tray spacer is required for use with A4 size paper.

Rhythm Formats

Defines the default values for rhythm printing. It is possible to set a 3 or 6-channel default rhythm format for the ELI 150c. For the ELI 250c, a 3, 6, or 12-channel default rhythm format is possible. Define rhythm leads one through three to customize a 3-channel rhythm printout or define rhythm leads one through six to customize the 6-channel rhythm printout.

Plot Format

Defines the default for one of the available plot formats in either standard or Cabrera presentation. Please note that regardless of the plot format selected, 10 seconds of 12 leads are always stored.

The ECG plot options are:

Format Option	ECG Data
3+1	2.5 seconds of 12 leads in a 3-channel format, plus 10-second rhythm strip of one user-selectable lead in a 1-channel format. Cabrera also available.
3 (ELI 150c only)	2.5 seconds of 12 leads in a 3-channel format. Cabrera also available.
6	5 seconds of 12-leads in a 6-channel format. Cabrera also available.
3+3	2.5 seconds of 12 leads in a 3-channel format, plus 10-second rhythm strip of user-selectable leads in a 3-channel format. Cabrera also available.
12 (ELI 250c only)	10 seconds of 12 leads in a one page printout.
6+6 (ELI 250c only)	5 seconds of 6 leads in a 6-channel format, plus 10-second rhythm strip of user-selectable leads in a 6-channel format. Cabrera also available.

Rhythm Leads

Displays continuous rhythm of selected ECG leads and permits printing of selected leads. User may toggle between selected leads, system set leads, or I, II, III, aVR, aVL, and aVF followed by V1, V2, V3, V4, V5, and V6.

NOTE: Rhythm acquisition is not stored in memory, only printed.

NOTE: See Unit Configuration section to acquire a rhythm printout.

Average RR

Enabling this option will display an averaged RR value to appear on the report.

QTcB

Enabling this option will display a Bazett's corrected QT value on the report along with the default linear QTc value.

QTcF

Enabling this option will display a Fridericia corrected QT value on the report along with the default linear QTc value.

ECG Capture

Up to 5 minutes accumulated ECG data can be acquired internally for use with the Best 10 feature. The device automatically selects the best 10 seconds from within the 5-minute buffer.

Users can switch between BEST 10 or LAST 10 by selecting **F5 (More)** followed by **F5 (Last)** or **F5 (Best)** depending on the current view.

Band Mode

Use 850/1900 MHz (US) or 900/1800 MHz (EU). (Applies to ELI 150c only.)

Sync Media

Defines the default transmission setting. Select None, Modem, LAN, WLAN, or GSM/GPRS (GSM/GPRS option applies to ELI 150c only). Optional connectivity options which have been purchased and installed will be available for default selection.

An ELI x50c communicating over GPRS can be configured to automatically set its clock to match the time on a time sync server. The time sync server must return a time stamp in the ELI x50c's local time zone via the **daytime** protocol (RFC 867). The time sync server must have a public IP address, and the standard port is 13. The server must return the time in one of the following formats:

Format 1

day mon dd HH:mm:ss yyyy

Example

Wed Jul 15 17:05:49 2010

Format 2

hh.mm.ss tt mm/dd/yyyy

Example

02:38:51 PM 07/18/2011

Time sync servers running the Dimension 4 (<http://www.thinkman.com/dimension4/index.htm>) time sync software support Format 1.

DHCP

Defines whether the Dynamic Host Communication Protocol (DHCP) will be used to obtain an IP address. If DHCP is Yes, the network will automatically and dynamically assign an IP address. If DHCP is No, you must enter the IP address, def gateway, and sub net mask.

NOTE: All parameters related to network connection must be entered under the direction of the IT Manager of the facility where the device is installed.

IP Address

Enter the fixed IP address for network transmissions (if DHCP is not selected).

Def Gateway

Enter the address of the default gateway (if DHCP is not selected).

Sub Net Mask

Enter the sub net address (if DHCP is not selected).

Host IP

Enter the IP address of the host server.

NOTE: Addresses are always entered as 4 sets of 3 digits; therefore, an address of 192.168.0.7 must be entered as 192.168.000.007.

Port Number

Enter the port number used by the host server.

LAN MAC

Shows the MAC address of the LAN.

Security (WEP)

Wired Equivalent Privacy (WEP) is an encrypted security protocol (part of the 802.11 standard). Access points can have multiple WEP keys stored. Each one of them is identified by a number (e.g., 1, 2, 3, 4).

WEP Key

Enter the WEP key number.

WEP Key ID

Enter the 128-bit WEP key ID value (26 digits in 13 sets of two digits).

WLAN MAC

Shows the MAC address of the device's wireless module for configuring access points.

SSID

Service Set Identifier (SSID) is the name of the wireless network. All ELI 150c electrocardiographs that will transmit to the same network must have the same SSID name. This field is case sensitive.

WPA-PSK/WPA2-PSK

Allows for implementation of the "personal mode" of WPA. This mode of encryption employs Temporal Key Integrity Protocol (TKIP) which dynamically changes keys as the system is used.

PSK Passphrase

The passphrase may be from eight to 63 ASCII characters or 64 hexadecimal digits (256 bits).

WPA-LEAP

Cisco® LEAP (Light Extensible Authorization Protocol) enables use of the device with wireless networks employing the LEAP encryption protocol.

LEAP User Name

User name can be up to 32 characters in length.

LEAP Password

LEAP password can contain up to 32 characters.

WPA2-PEAP

Enables use of the device with wireless networks employing the PEAP encryption protocol.

PEAP User Name

User name can be up to 63 characters in length.

PEAP Password

Password can contain up to 63 characters.

Worklist Management

The device can download and process ECG order lists from the E-Scribe or another compatible information management system which identifies the ECGs (or ECG orders) needed for particular patients. Implementation of an order-based workflow can significantly reduce demographic data entry errors at the electrocardiograph. Orders are deleted from the list when the ordered ECG is acquired.

When set to Standard, new order lists are appended to the remaining list. When set to Refresh, each new order list will override the previously downloaded one.

Comm. Protocol

Select UNIPRO32, DICOM32, OR DICOM32ext for software v1.x.x. DICOM32 and DICOM32ext are only available if the DICOM option has been installed. Select UNIPRO64 OR DICOM64 FOR SOFTWARE V2.x.x. DICOM64 is only available if the DICOM option has been installed.

***NOTE:** This parameter must be entered under the direction of the IT Manager of the facility where the device is installed.*

***NOTE:** Units ship by default with Comm Protocol set to UNIPRO32. The UNIPRO32 setting is not supported by E-Scribe versions prior to V8.10 or ELI Link versions prior to V3.00. For questions about compatibility of your device with E-Scribe or ELI Link and UNIPRO32, contact Welch Allyn Technical Support. Units shipped with v2.x.x software will not connect with E-Scribe and need Eli Link v4.0 or above.*

Sync Mode

Select None, XMT, or XMT+Orders. None requires a manual transmission of reports and then a second manual request to receive orders from the cardiology management system. XMT will automatically transmit the report; XMT+Orders will both transmit the report and retrieve the orders.

Sync Date/Time

Select Yes or No. Yes will synchronize the date/time with the approved cardiology management system. With No, there will be no date/time synchronization. Date/time synchronization is done through ELI Link V3.10 or later.

XMT Mandatory Fields

Defines fields required for ECG transmission to the cardiology management system. None will allow data transmission without limitation; Last Name requires the technician to enter a minimum of the Last Name; Last Name and ID requires the technician to enter a minimum of the Last Name and the patient's ID.

UNIT DISASSEMBLY

ELI 150c



ELI 250c



Removal of the Unit from Cart

For early model transport carts, remove the two thumbscrews from underneath the cart platform by turning counterclockwise. *Cart may not be exact model as pictured.

**The ELI 150c and ELI 250c are very similar in design, so only the ELI 150c will be shown, unless an important difference needs to be identified.*



When the newer Universal ECG Cart is being used, the cardiograph can be disconnected from the cart by removing the lever retention screw and sliding the locking lever as shown below.

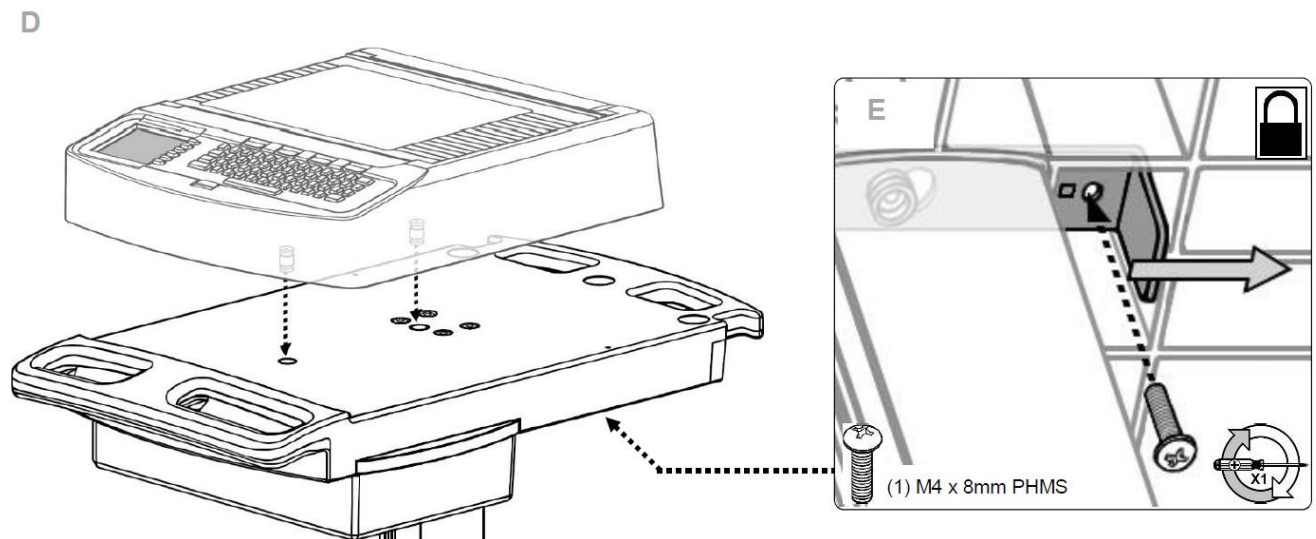

Cover Assembly Removal

Turn the unit upside down and use a T10 Torx driver to remove the 6 housing screws shown below. Once the screws are removed, carefully flip the Device back over so that it is upright.

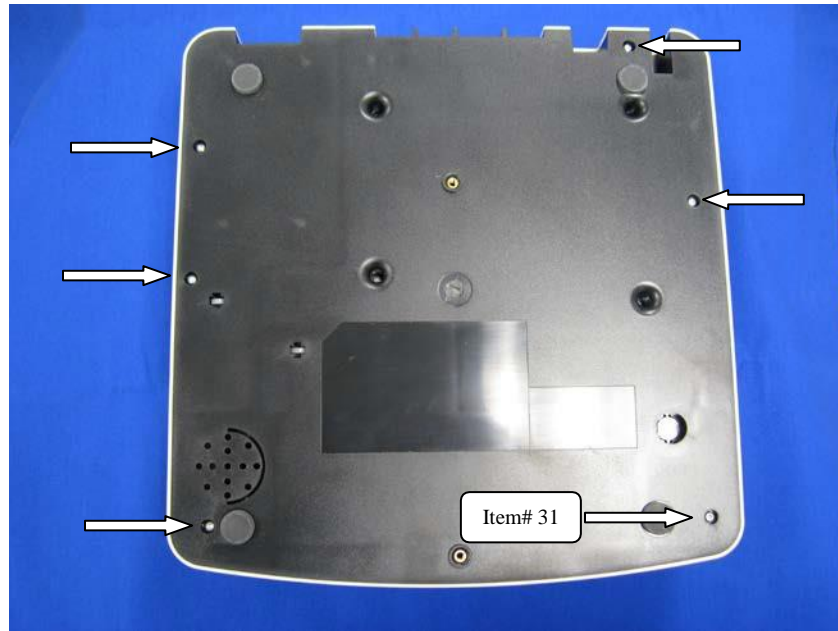

Open the writer drawer then lift the upper housing while rotating it counterclockwise according to the picture below. This will allow the writer cover to pass through the housing opening to free the upper housing.



CAUTION: Remove battery power to the unit by disconnecting the battery connector **BEFORE** removing the keyboard assembly. If battery power is not removed prior to disconnecting the keyboard cable, damage to the motherboard may result.

Writer Removal

To remove the writer assembly, remove the 4 chassis screws shown below. Once they are removed, carefully turn the unit over supporting the loose writer to ensure the cable connections are not stressed during the process.





Disconnect the writer interface cables and the motor cable shown below, then remove the writer assembly.



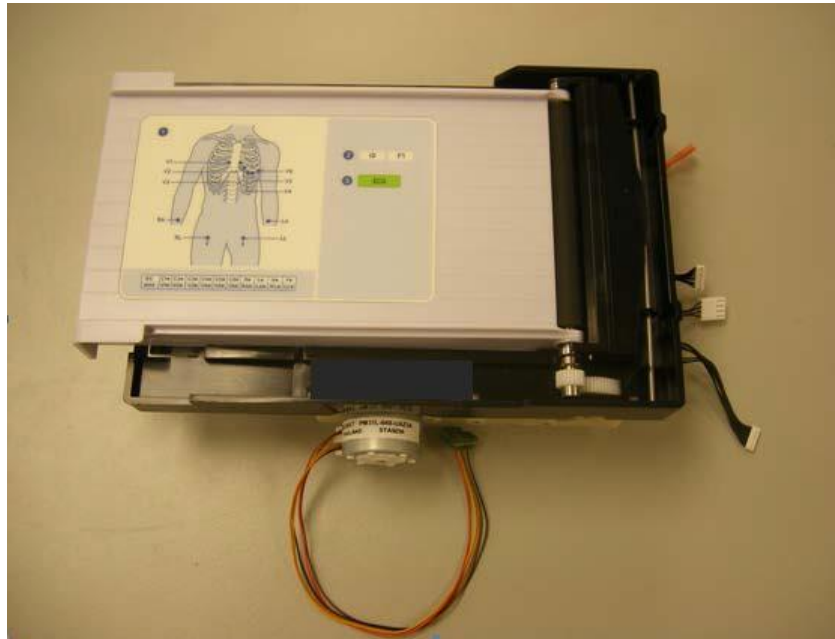

NOTE: The writer assembly can be obtained as a complete assembly for service purposes, or a specific part or subassembly can be obtained to repair a specific writer related issue. The entire writer door with the platen roller, latch assembly, and instruction label attached is available as an assembly; and the thermal print head, print head mount, anti-static brush, and associated cables are also available as an assembly. (Refer to the SERV ASSY item numbers on the item listing at the end of this section of the manual).

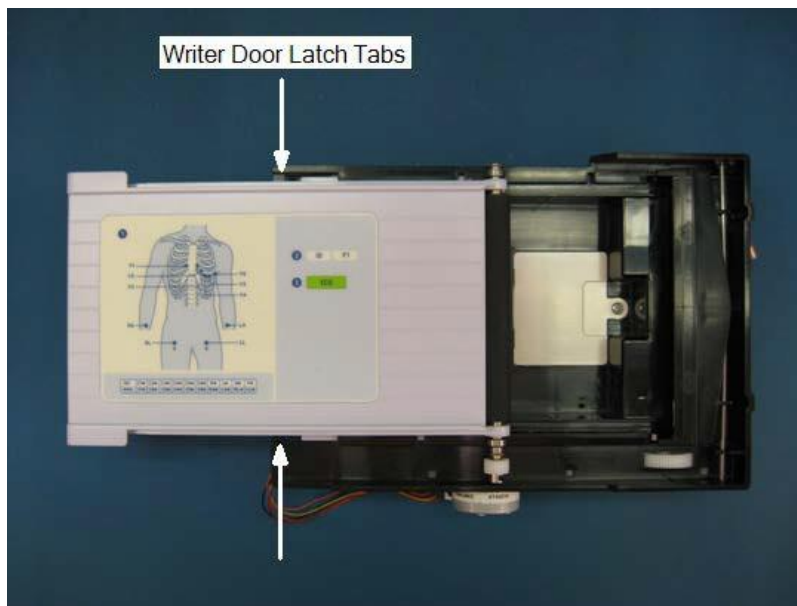

To remove the writer door assembly, slide the door open and press downward on the latching tabs to allow the writer door assembly to be slid out.

The writer latch mechanism can be disassembled to gain access to the writer latch bar and spring by removing the 4 screws shown below.

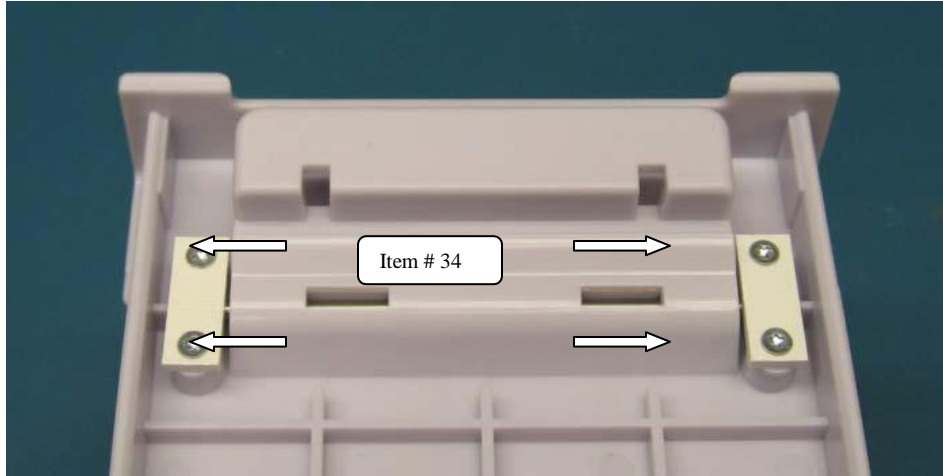

(View below with screws removed)



To remove the Gearbox assembly, remove the three screws as shown in the illustration below.

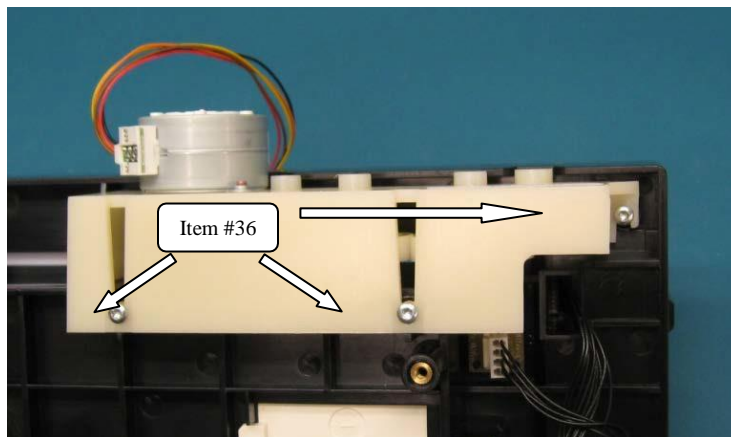



To remove the writer motor, the pinion gear must be removed by loosening the pinion set screw as shown above.

NOTE: The set screw is installed at the factory with a Vibra-Tite coating to prevent loosening due to vibration; ensure a coated set screw is used when reinstalling a new motor. The set screw should be tightened to a torque 3.5 pound inches to ensure a proper connection to the motor shaft.

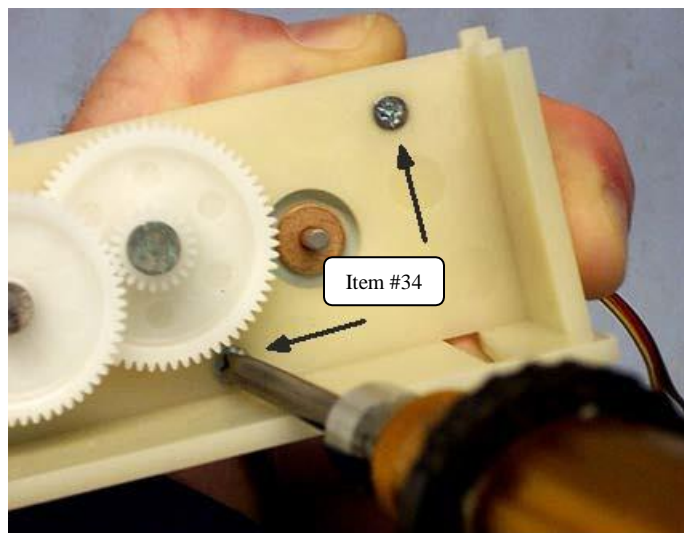

The motor can then be removed by the removal of the two mounting screws shown above (actual screws are TORX head for this product).

To remove the thermal print head assembly, remove the rubber O-ring as indicated in the illustration below.

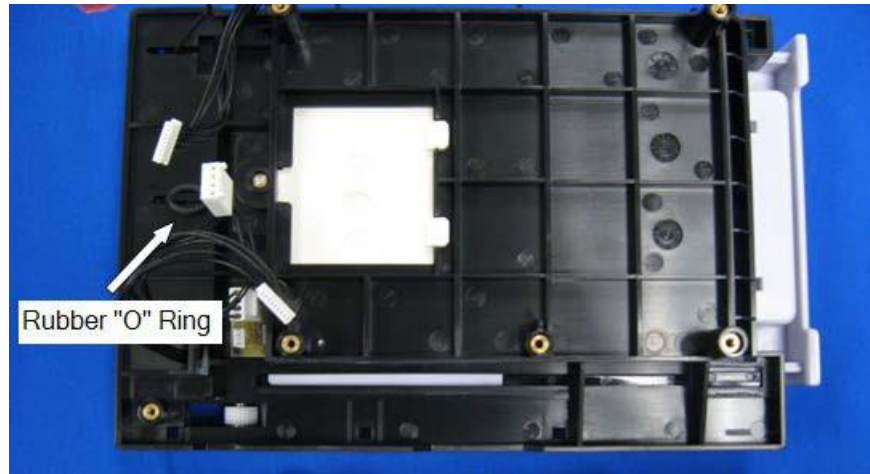

Next, flip the writer assembly over and lift the thermal print head assembly out, taking care to feed the wires through the writer base slots (shown below) as it is removed.

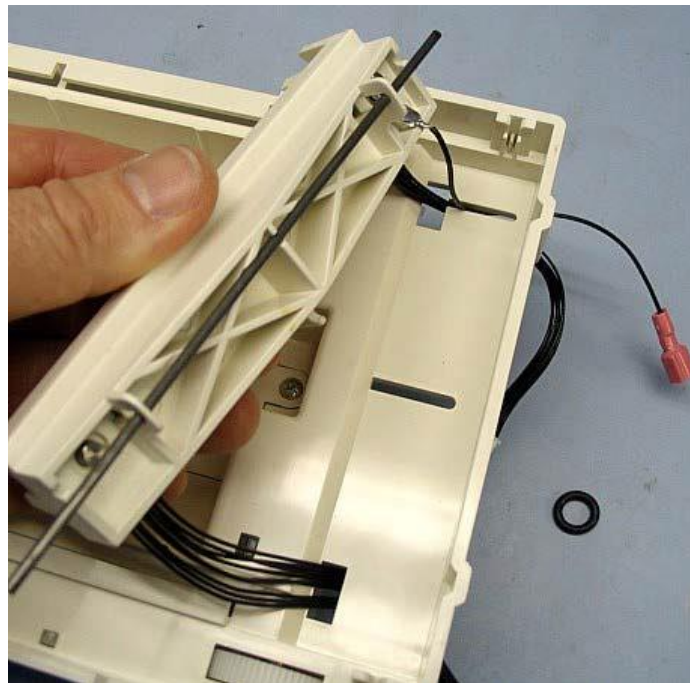



If the Print head assembly is disassembled further into the individual parts, care should be taken to re-torque the ground screw to 3.5 pound inches during reassembly; the shoulder screw can be tightened completely as it allows the Print head and mount to expand and contract when the device is exposed to abrupt temperature changes. When replacing the Print head, keep in mind that the anti-static brush is a separate item and can not be reused from the old Print head.

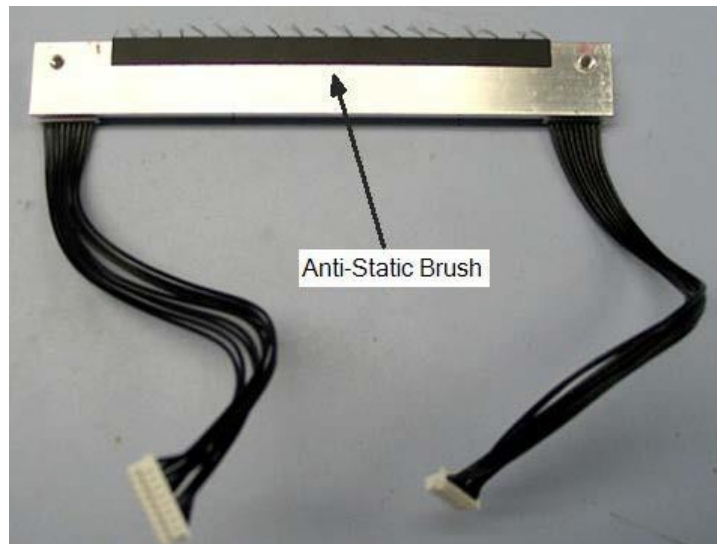

NOTE: When repairing units with symptoms of light or uneven print darkness, Welch Allyn recommends that the entire Print head assembly be replaced to ensure the problem resolved completely. Slight variances in the shape of the Print head and/or the print head mount can result in the unit exhibiting these symptoms. Replacement of the entire assembly will ensure the problem is completely resolved. (Refer to the SERV ASSY item numbers on the item listing at the end of this section of the manual).

Keyboard Removal



CAUTION: Remove battery power to the unit by disconnecting the battery connector **BEFORE** removing the keyboard assembly. If battery power is not removed prior to disconnecting the keyboard cable, damage to the motherboard may result.

Remove the 3 keyboard mounting screws which fasten the keyboard to the unit's lower housing (150c only).



Next, press firmly and outward on the keypad connector hold-downs (as shown below) to release the keyboard ribbon cable; then remove the keypad assembly from the bottom housing.

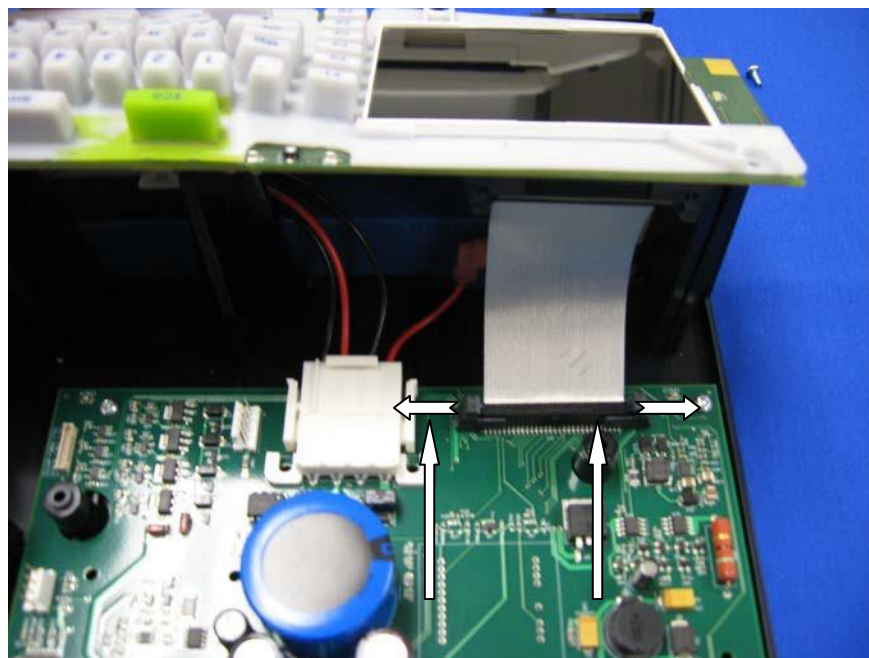

To remove the LCD Display, use a small flat blade screwdriver to lift up the latch mechanism that holds the LCD ribbon cable into the connector; then slide the cable out of the connector.

Be careful not to apply excessive force, as this connector mechanism is very small and fragile.

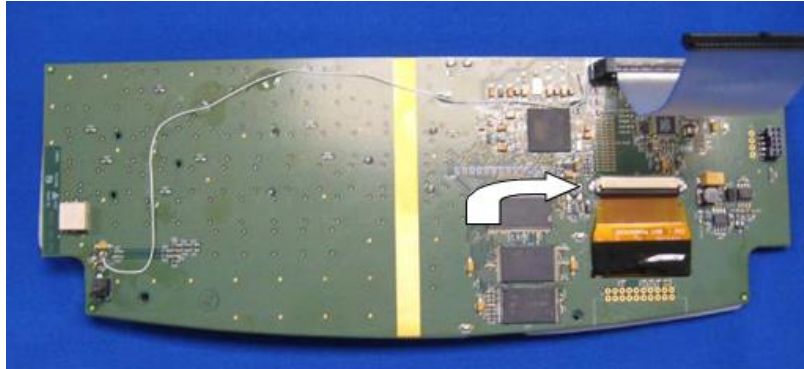

IMPORTANT ELI250c: A new ELI250C keyboard PCBA was introduced in 2019 that has compatibility requirements. The original part #36025-108-150 (item 107a) can use any software version, the newer part #36025-108-400 (item 107b) must operate using v1.3.2 or newer (series 1.x), or v2.1.1 or newer (series 2.x) software.

IMPORTANT ELI150c: A new ELI150C keyboard PCBA was introduced for 4th edition compliance in 2020 that has compatibility requirements. The original part #36025-102-150 (item 10a) can use any software version, the newer part #36025-102-400 (item 10b) must operate using v1.3.3 or newer (series 1.x), or v2.1.2 or newer (series 2.x) software.

The rubber keypad and LCD can then be separated from the keyboard PCB assembly.

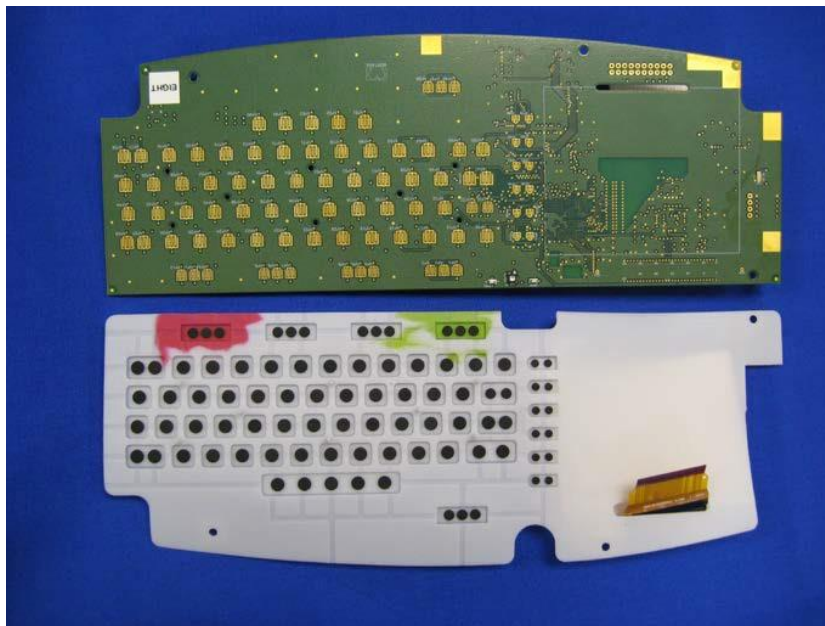

NOTE: When troubleshooting key press related issues, careful inspection and cleaning of the key pucks and PCB contacts should be performed prior to any electrical troubleshooting.

IMPORTANT ELI150c Keypad: A new ELI150C keypad was introduced for 4th edition compliance in 2020 that has compatibility requirements. Exchanging the identical part for servicing purposes is recommended, however if the older part (8359-003-50) is not available, the newer keypad (413252) can be used to service the older models. The older keypad **CANNOT** be used on the newer 4th edition compliant version. Refer to the table below for compatibility information.

	Original version ELI150c	4 th Edition Compliant ELI150c
8359-003-50	Yes	No
413252	Yes	Yes

The visual difference between the two keypads is shown below, the new part has a portion removed.

8359-003-50



413252



ELI150c 4th Edition gasket:

When servicing an ELI150c 4th edition device, there is also an additional item #92 used to reduce electromagnetic interference (EMI). When servicing the keyboard/keypad items, it may be necessary to replace the gasket material to ensure connectivity between the two surfaces. The gasket positioning is shown below.

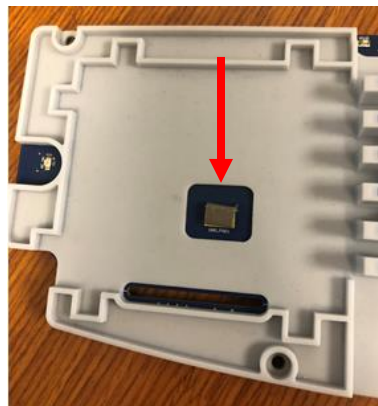

Remove the adhesive liner on the gasket, then mount the gasket to the pad within the cutout of the keypad.

Installation of the Ribbon Cable to the Keypad Assembly

The Main Processor is located on the Keypad Motherboard. When installing the ribbon cable onto the circuit board, it is imperative to install using the following process. If care is not taken when pressing the ribbon cable into the connector, damage to the solder connections to the Ball Grid Array of the processor due to flexing of the printed circuit board assembly could occur.

To install, ensure that the cable connector is correctly aligned with the board connector. Grasp the keypad side of the board with your forefingers, and press with equal pressure with both thumbs on the ribbon connector. Some force may be required to fully seat this connector. See picture below:

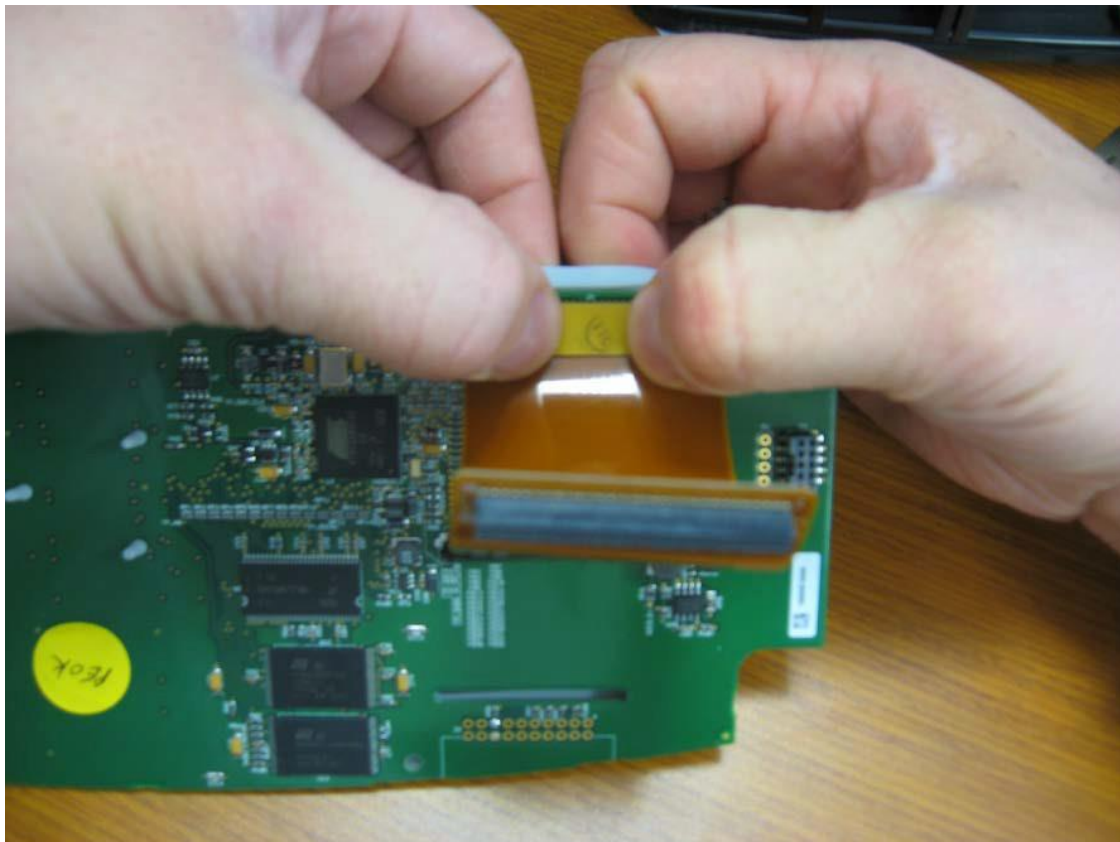

I/O Board Removal

Be sure the battery connector is disconnected, then remove the four screws as shown in illustration below.

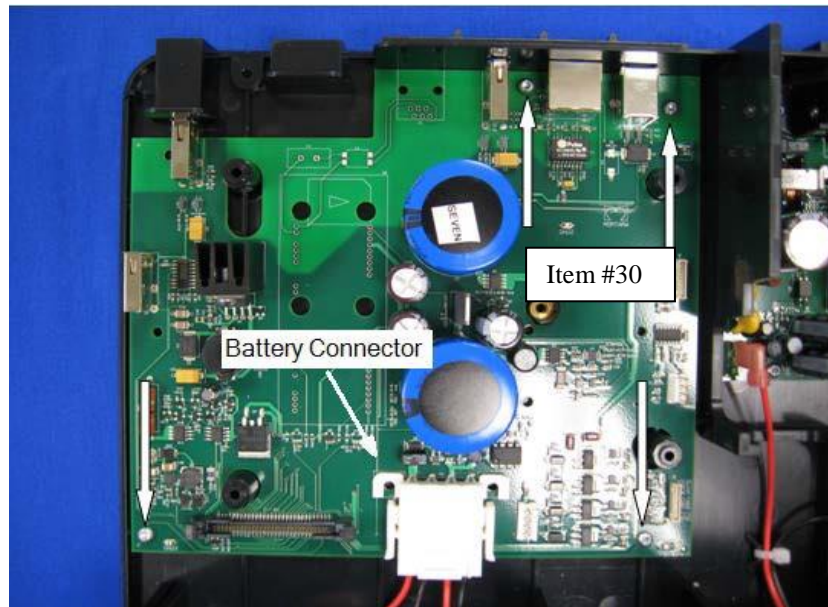

IMPORTANT ELI150c I/O Board: A new ELI150C I/O Board was introduced for 4th edition compliance in 2020 that has compatibility requirements. Exchanging the identical part for servicing purposes is recommended, however if the older part (26025-105-15x) is not available, the newer I/O Board can be used to service the older models. The older I/O Board **CANNOT** be used on the newer 4th edition compliant version. Refer to the table below for compatibility information.

	Original version ELI150c	4 th Edition Compliant ELI150c
26025-105-15x	Yes	No
26025-105-40x	Yes	Yes

The ELI250c can use either the 26025-105-15x or 26025-105-40x I/O board, without compliance concerns, depending on availability.

If the unit is equipped with an optional Wireless Acquisition Module (WAM), the Universal Transceiver Key (UTK) will be inserted into the secondary USB connector and held in place by the plastic housing ensure it does not become dislodged (see image below). The UTK may need to be transferred to the new I/O board if replaced during servicing activity.

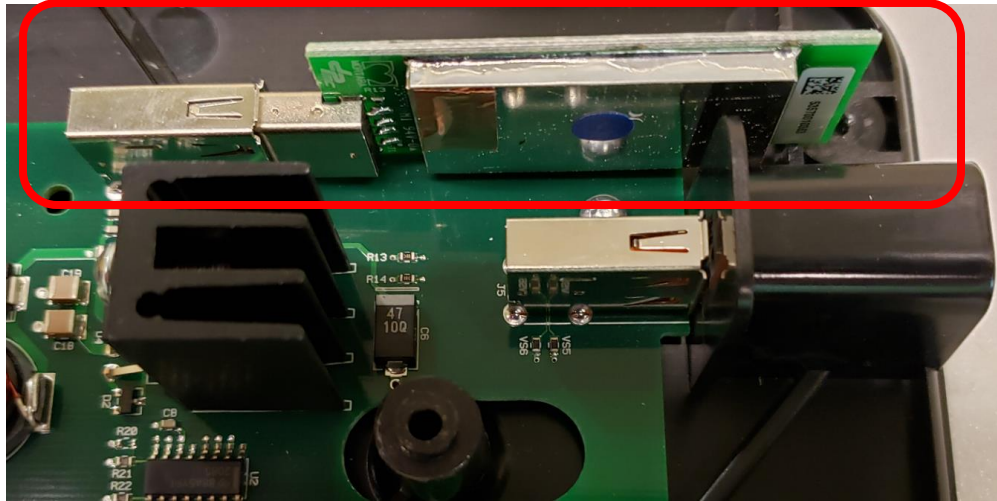

Refer to the Item Identification Table for the correct item (#90 a/b), as there are two versions of WAM/UTK pairs that must match (v1 to v1 or v2 to v2) for the wireless interface to operate properly. Units utilizing the v2 UTK will have a round “2” label (item # 91) near the ECG input connector on the housing.

To remove the Power Supply, disconnect the battery cables and then remove the 4 mounting screws as shown in illustration below.

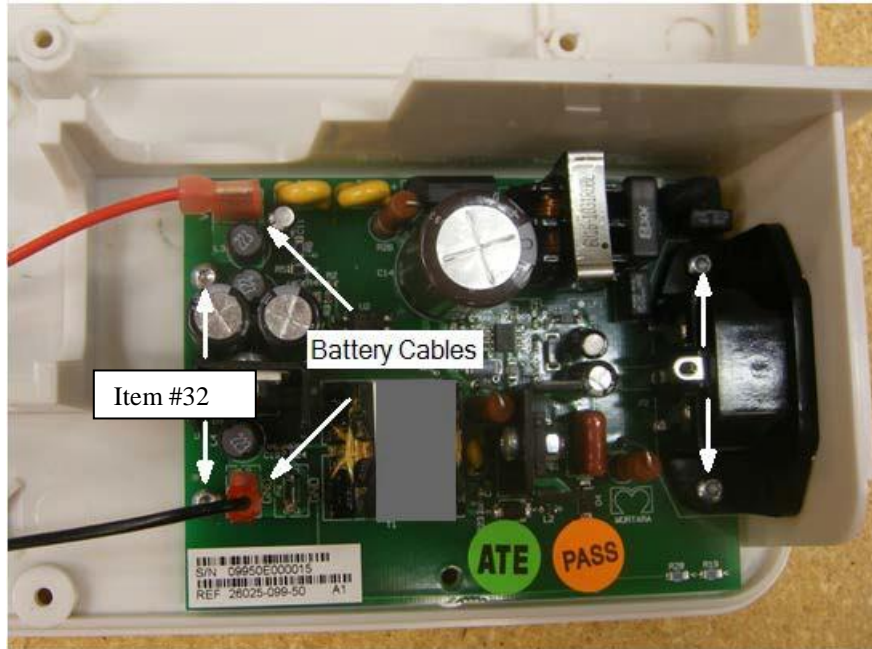

IMPORTANT ELI150c Power Supply Board: A new ELI150C Power Supply Board was introduced for 4th edition compliance in 2020 that has compatibility requirements. Exchanging the identical part for servicing purposes is recommended, however if the older part (26025-099-151) is not available, the newer power supply board can be used to service the older models. The older PCBA **CANNOT** be used on the newer 4th edition compliant version. Refer to the table below for compatibility information.

	Original version ELI150c	4 th Edition Compliant ELI150c
26025-099-151	Yes	No
26025-099-400	Yes	Yes

The ELI250c can use either the 26025-099-151 or 26025-099-400 power supply board, without compliance concerns, depending on availability.

Battery Replacement



CAUTION: Be careful not to short the positive and negative terminals of the battery with a metal tool when removing the battery from the unit; as this could result in damage to the unit, or personal injury to the repair technician.

The battery is installed at the factory by adhering it to the lower housing with two pieces of double stick foam tape. To remove the battery, insert a small prying tool underneath the battery in the area shown below; then carefully lift the battery edge to separate the battery from the lower housing. Removal of the battery will require a fair amount of force, as the foam tape will typically tear in the center leaving the adhesive portions on the battery and lower housing.



The adhesive left on the lower housing (as shown below) will need to be removed with a small scraping tool prior to installation of the new battery.

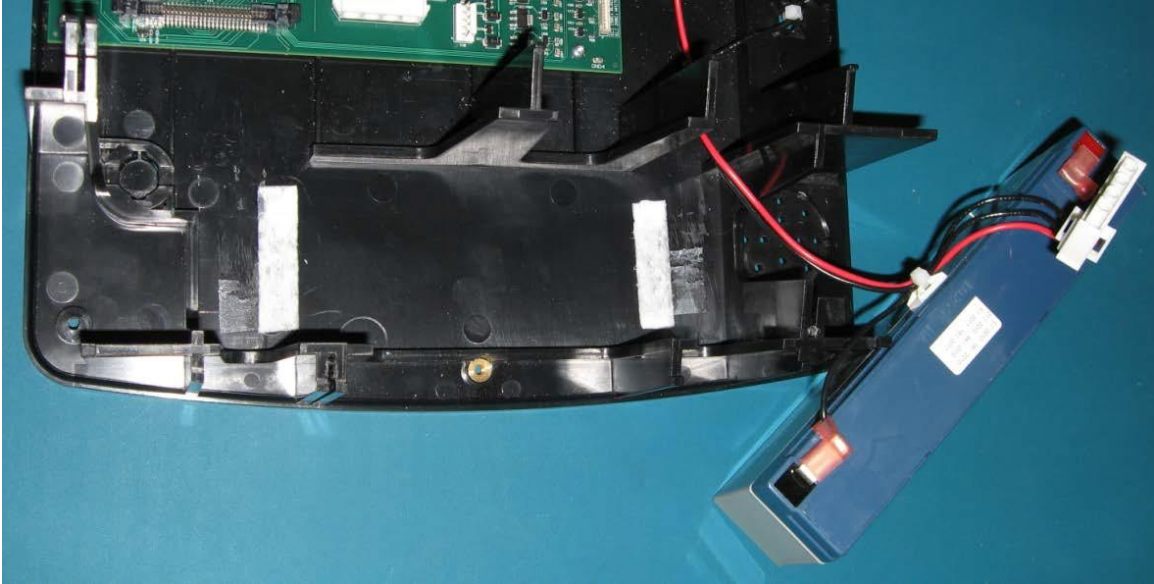

***NOTE:** Welch Allyn recommends that a battery assembly that includes the pre-mounted foam tape be obtained for battery replacements that are not performed in a Welch Allyn Service Center. This will ensure that the battery is properly adhered to the lower housing to avoid it being dislodge during use, and will allow for proper removal for routine maintenance. (Refer to the SERV ASSY item numbers on the item listing at the end of this section of the manual).*

Reassembly of the ELI 150c/250c can be performed by reversing the sequence of the previous disassembly procedure.

When installing screws for all circuit boards, use a torque driver set to 3.5 in/lbs.

When installing screws for Upper Housing and Writer Assembly, use a torque driver set to 5.0 in/lbs.

The items highlighted in grey that are listed in the ELI 150c item description listing identify the serviceable level of the device.

Some subcomponents of assemblies listed are not available as individual service items from Welch Allyn, the assembly level item must be used for servicing purposes.

Item numbers below 100 are also used with the ELI 150c. Item numbers above 100 are specific to ELI 250c.

ELI 150c Item Description Listing		
Item #	Part #	Description
1	22500-150-51	WRITER ASSEMBLY ELI/BUR 150c - NO LABEL (See Item # 74 for ELI or BUR label part number)
2	25018-034-50	CABLE ASSEMBLY ELI 200+ PRINTHEAD TO PCB
3	25020-060-50	CABLE ASSY CUE SENSOR TO MTHRBD ELI 200+
4	25020-067-50	GROUND WIRE FOR ELI 230 PRINTHEAD
5	25020-076-50	CABLE POWER INTERNAL ELI 150c
6	26025-045-151	ELI 200+ CUE SENSOR PCB ASSEMBLY
7	26025-073-50	SIM SIMULATOR PCB ASSEMBLY
8	26025-074-50	REMOTE SIM CONNECTOR PCB ASSEMBLY
9	26025-077-170	B&B-N WLAN MODULE PCB ASSY
10a	36025-102-150	ELI 150c KEYBOARD PCB ASSEMBLY -TESTED
10b	36025-102-400 *	ELI150c KEYBOARD PCB ASSY 4 th ED-TESTED
11	26025-110-150	ELI 150c FLEX CABLE INTERCONNECT
12	3171-009	CABLE ASSY COAX 6" SMA-F BLKHD to MMCX-M
13	3171-010	CABLE COAX U.FL TO RP-SMA BLKHD 100mm
14	3225-003	CONN, MOD PHONE, 4 PIN, RA, LO PRO
15	3225-008	CONN RJ-45 8 PIN SHIELDED w/GREEN LEDS
16	3375-004	CONN USB RECEPTACLE TYPE B
17	3375-006	CONN USB RECEPT TYPE A UPRIGHT HIGH RET
18	3600-008	ANTENNA F1 900/1800 MHz HINGED RA
19	3600-009	ANTENNA F2 850/1900 MHz RIGHT ANGLE
20	3600-016	ANTENNA DUAL BAND 2400/5000 MHz
21	4027-001	FUSE POLYSWITCH TR 600V 150mA
22	4027-002	FUSE 1A 250V TIME LAG RADIAL 8x8.5x4mm
23	4027-003	FUSE 5A 250V TIME LAG RADIAL 8x8.5x4mm
24	4800-006	BATTERY RECHARGEABLE SLA 12V 2.2/2.3Ah
25	5400-019	LCD 3.5" TFT ACTIVE MATRIX 320 x 240
26	5450-005	PRINTHEAD THERMAL 108mm 4.25"
28	600-0515	COMMON MODE CHOKE 2A 4 PIN SM
29	6001-002-01	SCREW, SHOULDER HEX M3 x 0.5 STAINLESS
30	6020-060	SCREW THD-FORM PAN HD TORX 4-20x1/4"
31	6020-061	SCREW THD-FORM PAN HD TORX 4-20x1/2"
32	6020-062	SCREW THD-FORM PAN HD TORX 4-20x3/8"
33	6020-430-02	SCREW PHILLIPS PAN HEAD M3 X 6mm COATED
34	6020-735-02	SCREW FLAT HD TORX M3 x 6 COATED
35	6020-835	SCREW PAN HD TORX M3 x 8
36	6020-835-02	SCREW PAN HD TORX M3 x 8 COATED

* Item has a software compatibility requirement.

ELI 150c Item Description Listing

Item #	Part #	Description
37	6030-025	SET SCREW SOCKET M2.5 x 4
38	6100-004	WASHER, WAVE, .006/.030 x .18 x .25
39	6125-004	SPACER .19 x .25 x .125
40	6125-017	SPACER .19 X .25 X .063
41	6140-003	E-RING FOR 0.187 SHAFT ZN-PLATED STEEL
42	6141-003	O-RING BUNA-N 1/2 OD X 5/16 ID
43	6160-003	STANDOFF NYLON SNAP BOTH ENDS 0.062 BD
44	6320-003	FOOT BLACK .64 OD X .115 ADHESIVE
45	6520-003	BEARING BALL .1875ID SS
46	6545-007-01	MOTOR STEPPER PM 35mm 24V 40Ohm WINDINGS
47	6570-420-01	PLATEN / SHAFT 4.200 x 0.551 DIA
48	7400-019	TAPE POLYESTER FILM 1" X .05mm
49	7401-003	TAPE 2SIDED ADHESIVE 0.031 THK x.50 WIDE
50	7403-001	VIBRA-TITE 1oz
51	7480-090	BRUSH ANTI-STATIC 90mm FLEXIBLE
52	7495-001	CABLE TIE LOCKING 3.9 x .10
58	8342-004-52	GEAR BOX ELI 200+ IML/OPM
59	8342-008-02	LATCH RELEASE ELI 250c
60	8342-009-01	GEAR SPUR 22 TEETH WITH STAINLESS HUB
61	8342-018-01	BAR RELEASE PIVOT 3.950 X .118 DIA.
62	8342-019-01	SPRING COMPRESSION .5 OD X .85 L
63	8342-020-01	PIVOT BAR RESTRAINING PLATE
64	8347-004-51	PAPER TRAY ELI 150c
65	8347-005-51	PAPER TRAY COVER ELI 150c
66	8347-006-51	PRINTHEAD MOUNT ELI 150c
67	8347-007-51	ACCESS COVER ELI 150c
68	8347-009-50	SPRING BAR 6.1 x 0.093 DIA
69	8359-001-50	HOUSING UPPER ELI 150c
70	8359-002-50	HOUSING LOWER ELI 150c
71a	8359-003-50	KEYPAD ELASTOMERIC ELI 150c UNIVERSAL
71b	413252	KEYPAD ELASTOMERIC ELI 150c 4 th ED
72	8359-004-51	LCD BEZEL ELI/BUR 150c
73	9025-049-02	LABEL ELI 2XX MULTITECH MODEM ID
74	9042-073-01 9042-073-02 9042-073-12	LABEL ELI 150c USER INSTRUCTIONS LABEL BUR 150c USER INSTRUCTIONS BURDICK LABEL BUR 150c USER INST BURDCK/McKESSON
75	9050-059-05	LABEL REG MT GSM F4
76	9050-059-06 9050-059-09 9050-059-10	LABEL REG WLAN DPAC-G2 LABEL REG WLAN QUATECH-G2 LABEL REG WLAN B&B
77	9050-059-07	LABEL REGULATORY UTK
78	421461 421479 421462	LABEL ELI 150c NAMEPLATE LABEL ELI 150c INMETRO NAMEPLATE LABEL ELI 150c NAMEPLATE McKESSON

ELI 150c Item Description Listing

Item #	Part #	Description
79	9910-017	MODEM MULTITECH MT5600 V.92 5V SERIAL
80	9910-022	MODEM GSM MT SCKTMOD F4 QUAD-BAND US/EU
81a	26025-099-151	AC POWER SUPPLY 16VDC PCB ASSY w/UL
81b	26025-099-400	AC POWER SUP 16VDC wUL_4THED
82a	26025-105-151 26025-105-152 26025-105-153 26025-105-154	ELI 150c/250c I/O CONNECTOR PCB ASSEMBLY w/o COMM ELI 150c/250c I/O CONNECTOR PCB ASSY w/MODEM ELI 150c/250c I/O CONNECTOR PCB ASSY w/GSM ELI 150c/250c I/O CONNECTOR PCB ASSY w/LAN+WLAN
82b	26025-105-400 26025-105-401 26025-105-402 26025-105-403	ELI 150c/250c I/O CONN PCB ASSY w/o COM ELI 150c/250c I/O CONN PCB ASSY w/MODEM ELI 150c/250c I/O CONN PCB ASSY w/GSM ELI150c/250c I/O CON PCB ASSY w/LAN+WLAN
83	SERV-ASSY-177-01	BATTERY 12V 2.2/2.3Ah WITH FOAM TAPE
84	SERV-ASSY-177-02	ELI/BUR 150C WRITER LID ASSEMBLY – NO LABEL (See Item # 74 for ELI or BUR label part number)
85	41000-028-53	ELI150C PRINthead ASSEMBLY
90a	26025-092-151	USB TRANSCEIVER KEY (UTK) ASSEMBLY v1.x
90b	26025-092-404	UTK w/Software v2.x
91	728940	v2 UTK Label for Cardiographs
92	728427	Gasket EMI Foam 3mm H x 0.33" L

The items highlighted in grey that are listed in the ELI 250c item description listing identify the serviceable level of the device.

Some subcomponents of assemblies listed are not available as individual service items from Welch Allyn, the assembly level item must be used for servicing purposes.

Item numbers below 100 are also used with the ELI 150c. Item numbers above 100 are specific to ELI 250c.

ELI 250c Item Description Listing		
Item #	Part #	Description
101	22500-250-50	WRITER ASSEMBLY ELI 250c – NO LABEL (See Item # 122 for ELI or BUR label part number)
102	25018-046-50	CABLE ASSY BLK PRINTHEAD TO PCB ELI 250c
103	25018-047-50	CABLE ASSY WHT PRINTHEAD TO PCB ELI 250c
104	25020-074-50	CABLE ASSY CUE SENSOR TO PCB ELI 250c
105	25020-075-50	GROUND WIRE FOR ELI 250c PRINTHEAD
106	25020-077-50	CABLE POWER INTERNAL ELI 250c
6	26025-045-151	ELI 200+ CUE SENSOR PCB ASSEMBLY
9	26025-077-170	B&B-N WLAN MODULE PCB ASSY
107a	36025-108-150	ELI 250c KEYBOARD PCB ASSEMBLY - TESTED
107b	36025-108-400 *	ELI 250c KEYBOARD PCB ASSY 4TH - TESTED
128	26025-111-150	ELI 250c FLEX CIRCUIT ASSEMBLY
13	3171-010	CABLE COAX U.FL TO RP-SMA BLKHD 100mm
14	3225-003	CONN, MOD PHONE, 4 PIN, RA, LO PRO
15	3225-008	CONN RJ-45 8 PIN SHIELDED w/GREEN LEDS
16	3375-004	CONN USB RECEPTACLE TYPE B
17	3375-006	CONN USB RECEPT TYPE A UPRIGHT HIGH RET
20	3600-016	ANTENNA DUAL BAND 2400/5000 MHz
21	4027-001	FUSE POLYSWITCH TR 600V 150mA
22	4027-002	FUSE 1A 250V TIME LAG RADIAL 8x8.5x4mm

* Item has a software compatibility requirement.

ELI 250c Item Description Listing





Item #	Part #	Description
23	4027-003	FUSE 5A 250V TIME LAG RADIAL 8x8.5x4mm
24	4800-006	BATTERY RECHARGEABLE SLA 12V 2.2/2.3Ah
25	5400-019	LCD 3.5" TFT ACTIVE MATRIX 320 x 240
108	5450-004	PRINthead THERMAL 216mm 8.50"
28	600-0515	COMMON MODE CHOKE 2A 4 PIN SM
29	6001-002-01	SCREW, SHOULDER HEX M3 x 0.5 STAINLESS
30	6020-060	SCREW THD-FORM PAN HD TORX 4-20x1/4"
31	6020-061	SCREW THD-FORM PAN HD TORX 4-20x1/2"
32	6020-062	SCREW THD-FORM PAN HD TORX 4-20x3/8"
34	6020-735-02	SCREW FLAT HD TORX M3 x 6 COATED
35	6020-835	SCREW PAN HD TORX M3 x 8
36	6020-835-02	SCREW PAN HD TORX M3 x 8 COATED
37	6030-025	SET SCREW SOCKET M2.5 x 4
38	6100-004	WASHER, WAVE, .006/.030 x .18 x .25
39	6125-004	SPACER .19 x .25 x .125
40	6125-017	SPACER .19 X .25 X .063
41	6140-003	E-RING FOR 0.187 SHAFT ZN-PLATED STEEL
42	6141-003	O-RING BUNA-N 1/2 OD X 5/16 ID
44	6320-003	FOOT BLACK .64 OD X .115 ADHESIVE
45	6520-003	BEARING BALL .1875ID SS
46	6545-007-01	MOTOR STEPPER PM 35mm 24V 40Ohm WINDINGS
109	6570-842-02	PLATEN / SHAFT 8.421 x 0.551 DIA
49	7401-003	TAPE 2SIDED ADHESIVE 0.031 THK x.50 WIDE
50	7403-001	VIBRA-TITE 1oz
51	7480-090	BRUSH ANTI-STATIC 90mm FLEXIBLE
52	7495-001	CABLE TIE LOCKING 3.9 x .10
110	7495-012	CABLE TIE, LOCKING, 5.6 x .10
113	8342-003-51	PAPER TRAY COVER ELI 250c
114	8342-004-53	GEAR BOX ELI 200+ IML/IPM
115	8342-005-51	PAPER TRAY ELI 250c
116	8342-006-03	PRINthead MOUNT ELI 250c
59	8342-008-02	LATCH RELEASE ELI 250c
60	8342-009-01	GEAR SPUR 22 TEETH WITH STAINLESS HUB
117	8342-017-01	SPRING BAR 10.125 X .156 DIA.
61	8342-018-01	BAR RELEASE PIVOT 3.950 X .118 DIA.
62	8342-019-01	SPRING COMPRESSION .5 OD X .85 L
63	8342-020-01	PIVOT BAR RESTRAINING PLATE
118	8342-025-50	RETAINER CLIP ELI 2XX WRITER SPRING BAR
119	8360-001-50	HOUSING UPPER ELI 250c
120	8360-002-50	HOUSING LOWER ELI 250c
121	8360-003-50	KEYPAD ELASTOMERIC ELI 250c
73	9025-049-02	LABEL ELI 2XX MULTITECH MODEM ID

ELI 250c Item Description Listing



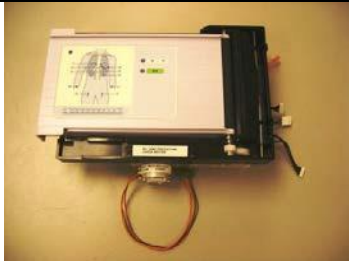
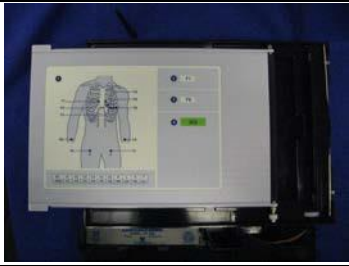

Item #	Part #	Description
122	9042-074-01 9042-074-02	LABEL ELI 250c USER INSTRUCTIONS LABEL BUR 250c USER INSTRUCTIONS-BURDICK
76	9050-059-06 9050-059-09 9050-059-10	LABEL REG WLAN DPAC-G2 LABEL REG WLAN QUATECH-G2 LABEL REG WLAN B&B
77	9050-059-07	LABEL REGULATORY UTK
123	421463 9050-087-02	LABEL ELI 250c NAMEPLATE LABEL ELI 250c INMETRO NAMEPLATE
124	9326-002	ADHESIVE CYANOACRYLATE ESTER
79	9910-017	MODEM MULTITECH MT5600 V.92 5V SERIAL
81a	26025-099-151	AC POWER SUPPLY 16VDC PCB ASSY w/UL
81b	26025-099-400	AC POWER SUP 16VDC wUL_4THED
82	26025-105-151 26025-105-152 26025-105-154	ELI 150c/250c I/O CONNECTOR PCB ASSEMBLY w/o COMM ELI 150c/250c I/O CONNECTOR PCB ASSY w/MODEM ELI 150c/250c I/O CONNECTOR PCB ASSY w/LAN+WLAN
83	SERV-ASSY-177-01	BATTERY 12V 2.2/2.3Ah WITH FOAM TAPE
125	SERV-ASSY-178-02	ELI/BUR 250C WRITER LID ASSEMBLY – NO LABEL (See Item # 122 for ELI or BUR label part number)
126	41000-028-52	ELI250C PRINthead ASSEMBLY
127	8360-004-50	LCD BEZEL ELI/BUR 250c
90a	26025-092-151	USB TRANSCEIVER KEY (UTK) ASSEMBLY v1.x
90b	26025-092-404	UTK w/Software v2.x
91	728940	v2 UTK Label for Cardiographs

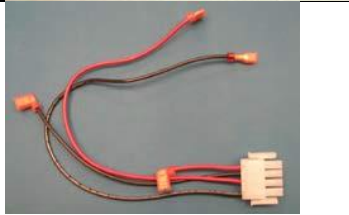
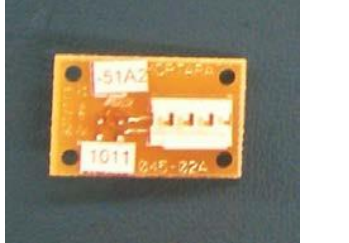
Item numbers below 100 are also used with the ELI 150c. Item numbers above 100 are specific to ELI 250c.



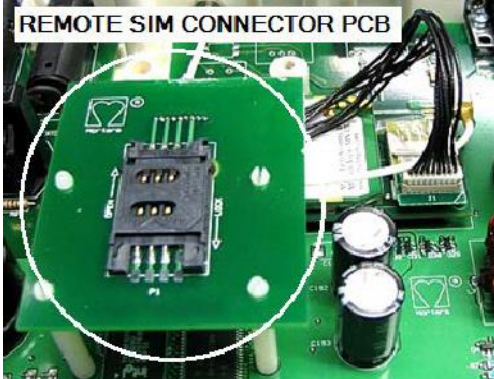

(The item ID table below is sorted by part #)

ELI 150c/250c Item Identification Table		
Item #	Part #	Picture
1	22500-150-51	 (Label not included)
101	22500-250-50	 (Label not included)
2	25018-034-50	
3	25020-060-50	
4	25020-067-50	
5	25020-076-50	
6	26025-045-151	



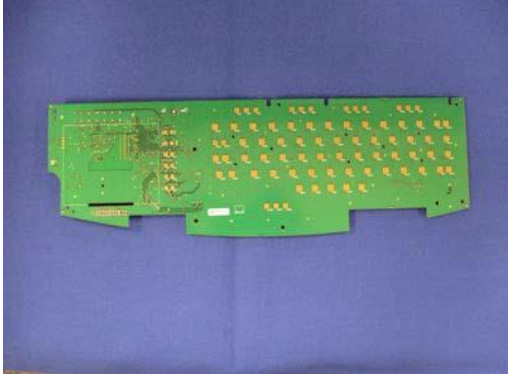

ELI 150c/250c Item Identification Table

Item #	Part #	Picture
7	26025-073-50	 <p>A small green printed circuit board (PCB) with several gold-plated pins extending from one side. It is being held between fingers. A white label with the text "SIM SIMULATOR PCB" is overlaid on the top of the board.</p>
8	26025-074-50	 <p>A green PCB mounted on a larger board. A SIM card slot is highlighted with a white circle. A white label with the text "REMOTE SIM CONNECTOR PCB" is overlaid at the top of the image.</p>
9	26025-077-170	 <p>Two green PCB modules. The one on the left is a radio module with a white label containing technical specifications and a barcode. The one on the right is a smaller module with a similar label.</p>
	9910-023-03 (radio only)	 <p>A close-up view of a radio module PCB, similar to the one in the previous row, showing the white label with technical details.</p>
10	36025-102-150	 <p>A large green PCB with a grid of gold-plated pins on one side, likely a connector board.</p>



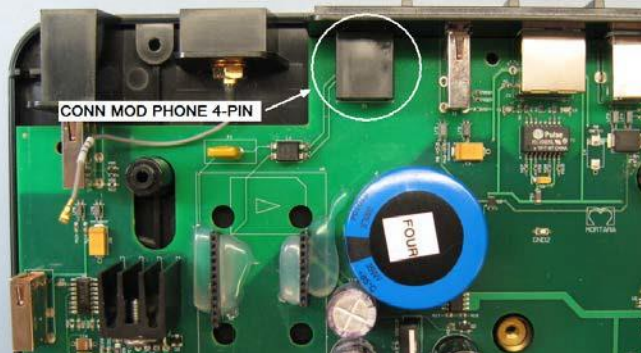

ELI 150c/250c Item Identification Table

Item #	Part #	Picture
107	36025-108-150	
11	26025-110-150	
128	26025-111-150	
12	3171-009	<p style="text-align: center;">CABLE COAX 6" SMA-F to MMCX-M</p> 
13	3171-010	<p style="text-align: center;">CABLE COAX U.FL to RP-SMA BULKHEAD</p> 



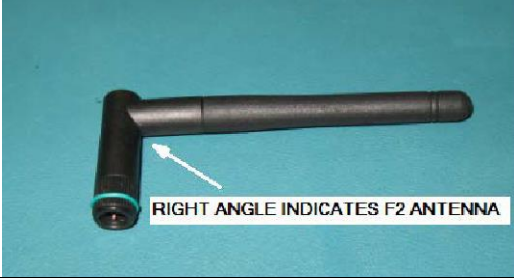

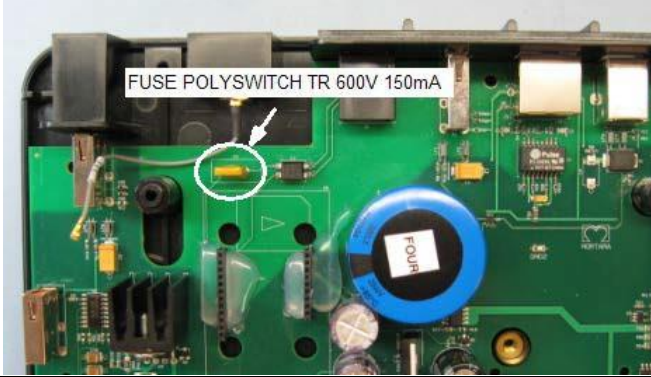
ELI 150c/250c Item Identification Table

Item #	Part #	Picture
14	3225-003	
15	3225-008	
16	3375-004	
17	3375-006	



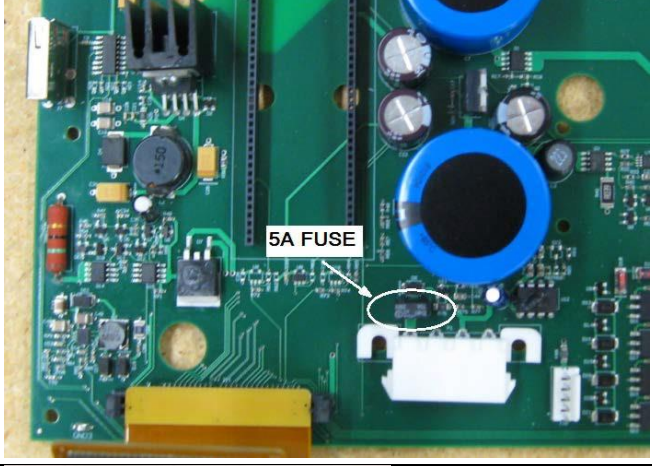





ELI 150c/250c Item Identification Table

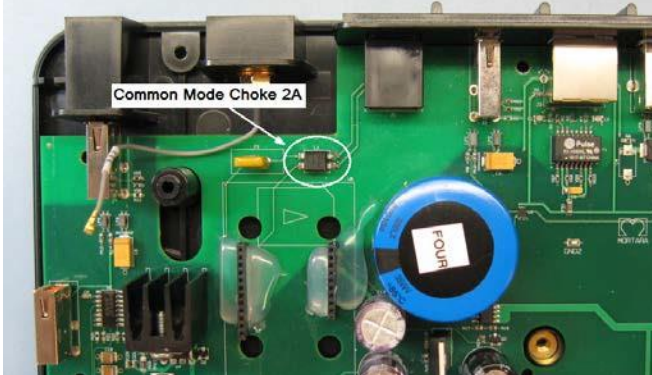





Item #	Part #	Picture
18	3600-008	
19	3600-009	
20	3600-016	
21	4027-001	
22	4027-002	

ELI 150c/250c Item Identification Table

Item #	Part #	Picture
23	4027-003	
24	4800-006	
25	5400-019	
108	5450-004	
26	5450-005	





ELI 150c/250c Item Identification Table





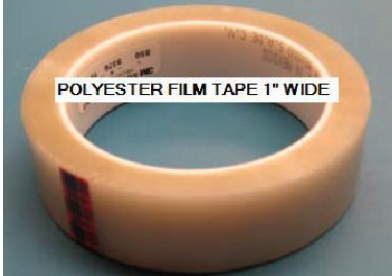

Item #	Part #	Picture
28	600-0515	
29	6001-002-01	
30	6020-060	
31	6020-061	
32	6020-062	
33	6020-430-02	
34	6020-735-02	
35	6020-835	

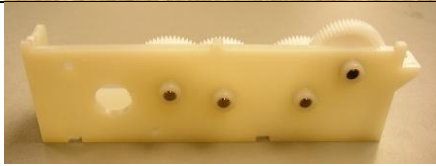
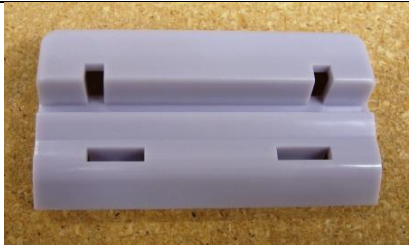
ELI 150c/250c Item Identification Table		
Item #	Part #	Picture
36	6020-835-02	
37	6030-025	
38	6100-004	
39	6125-004	
40	6125-017	
41	6140-003	
42	6141-003	

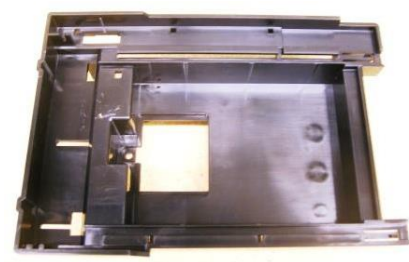
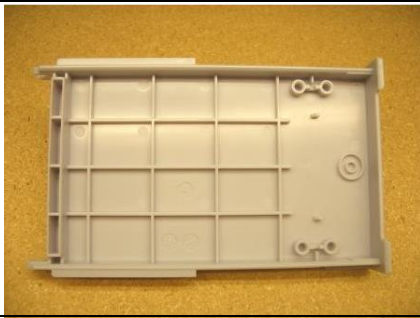

ELI 150c/250c Item Identification Table		
Item #	Part #	Picture
43	6160-003	
44	6320-003	
45	6520-003	
46	6545-007-01	
47	6570-420-01	

ELI 150c/250c Item Identification Table

Item #	Part #	Picture
48	7400-019	
49	7401-003	
50	7403-001	
51	7480-090	
52	7495-001	
58 114	8342-004-52 8342-004-53	
59	8342-008-02	

ELI 150c/250c Item Identification Table		
Item #	Part #	Picture
60	8342-009-01	
61	8342-018-01	
62	8342-019-01	
63	8342-020-01	
64	8347-004-51	
65	8347-005-51	
66	8347-006-51	

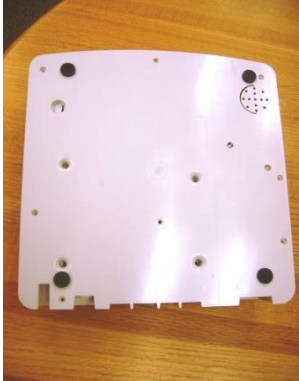







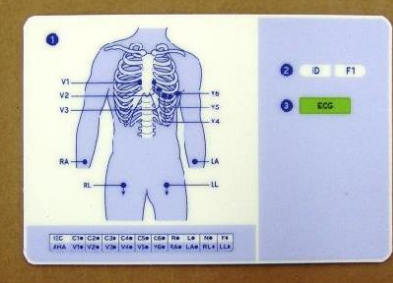
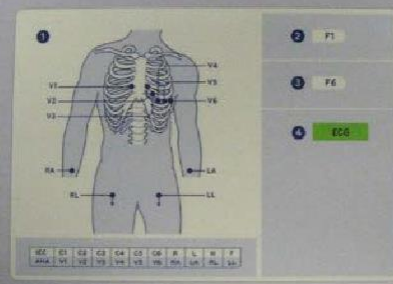



ELI 150c/250c Item Identification Table

Item #	Part #	Picture
67	8347-007-51	
68	8347-009-50	
69	8359-001-50	
70	8359-002-50	
71	8359-003-50	
71b	413252	

ELI 150c/250c Item Identification Table		
Item #	Part #	Picture
72	8359-004-51	
119	8360-001-50	
120	8360-002-50	
121	8360-003-50	





ELI 150c/250c Item Identification Table

Item #	Part #	Picture
73	9025-049-02	<p>Modem: MULTITECH MT5600SMI-92 56K Global</p> <p>FC Tested to Comply with FCC Standards. FOR HOME OR OFFICE USE.</p> <p>Complies with Part 68 of FCC Regulations. FCC Reg: AU7USA-46014-MD-E REN 0.1B CANADA IC: 125 11142A CLASS/CLASSE (B) </p>
74	9042-073-01 (ELI) 9042-073-02 (BUR) 9042-073-12 (MLBUR)	
122	9042-074-01 (ELI) 9042-074-02 (BUR)	
75	9050-059-05	<p>GSM Modem: MULTITECH SYSTEMS, INC. Model: MTSMC-G-F4 CE 0682 FCC ID: AU792U07A31817 IC: 125A-0027</p> <p>This device complies with Part 15 of the FCC rules and does not exceed the Class A limits for radio noise emissions for digital apparatus as set out in the Industry Canada standard ICES-003. Operation is subject to the following two conditions: (1) This device may not cause harmful interference, and (2) This device must accept any interference received including interference that may cause undesired operation.</p>
76	9050-059-06	<p>Wireless LAN Module: QUATECH, INC. Model: WLNG-AN-MR501 FCC ID: F4AWLNG1 IC: 3913A-WLNG1</p> <p>This device complies with part 15 of the FCC rules. Operation is subject to the following two conditions: 1) This device may not cause harmful interference, and 2) This device must accept any interference received including interference that may cause undesired operation.</p>





ELI 150c/250c Item Identification Table		
Item #	Part #	Pict ure
76	9050-059-09	<p>Wireless LAN Module: QUATECH, INC. Model: WLNG-AN-MR551 FCC ID: F4AWLNG551 IC: 3913A-WLNG551</p> <p>This device complies with part 15 of the FCC rules. Operation is subject to the following two conditions: 1) This device may not cause harmful interference, and 2) This device must accept any interference received including interference that may cause undesired operation.</p>
76	9050-059-10	<p>Wireless LAN Module: B&B Electronics Model: WLNN-AN-MR551 FCC ID: F4AWLNN551 IC: 3913A-WLNN551</p> <p>This device complies with part 15 of the FCC rules. Operation is subject to the following two conditions: 1) This device may not cause harmful interference, and 2) This device must accept any interference received including interference that may cause undesired operation.</p>
77	9050-059-07	<p>Internal Radio Model: UTK FCC ID: HJR-UTK2500 IC: 3758B-UTK2500</p> <p>This device complies with part 15 of the FCC rules. Operation is subject to the following two conditions: 1) This device may not cause harmful interference, and 2) This device must accept any interference received including interference that may cause undesired operation.</p>
78a	9050-086-01 (ELI) (older version label on top)	<div style="border: 1px solid black; padding: 5px;"> <p>Mortara INSTRUMENT MILWAUKEE, WI USA</p> <p>ELI 1XX SERIES 2 ELECTROCARDIOGRAPH</p> <p>MEDICAL EQUIPMENT</p> <p>    </p> <p>UL2601-1, IEC60601-1, CAN/CSA C22.2 No. 601.1, IEC 60601-2-25</p> <p>5P35</p> <hr/> <p>OPTIONAL INTERNAL RADIO MODEL: UTK</p> <p>This device complies with part 15 of the FCC rules. Operation is subject to the following two conditions: (1) this device may not cause harmful interference, and (2) this device must accept any interference received, including interference that may cause undesired operation.</p> <p>FCC ID: HJR-UTK2500 IC:3758B-UTK2500</p> </div> <div style="border: 1px solid black; padding: 5px; margin-top: 10px;"> <p>Welch Allyn® ELI® 150C ELECTROCARDIOGRAPH  Welch Allyn, Inc. 4341 State Street Road Skaneateles Falls, NY 13153 USA</p> <p>100-240V ~ 50/60 Hz 110 VA</p> <p># 901129 ELECTROCARDIOGRAPH</p> <p> Welch Allyn Limited Navan Business Park Dublin Road Navan, County Meath Republic of Ireland C15 AW22</p> <p></p> <p>   </p> <p>E467322 welchallyn.com Made in USA</p> </div>

78b	9050-086-11 (MLBUR)	<p> ELI 1XX SERIES 2 ELECTROCARDIOGRAPH Distributed by Mokkesson Medical - Surgical Inc. 100-240V ~ 50/60 Hz 110VA # 901129 ELECTROCARDIOGRAPH EC REP Welch Allyn Limited Navan Business Park Dublin Road Navan, County Meath Republic of Ireland C15AW22 7d www.welchallyn.com MD CLASSIFIED c UL US E467322 CE 0455 Made in USA </p>
78c	9050-086-02 (INMETRO)	<p> Welch Allyn® ELI® 150C ELECTROCARDIOGRAPH ELETROCARDIOGRAFOS EQUIPAMENTOS MEDICOS SN REF ANVISA nº: 80117580259 # 901129 ELECTROCARDIOGRAPH 7d www.welchallyn.com MD CLASSIFIED c UL US E467322 (()) 7d www.hillrom.com Made in the USA </p>
79	9910-017	

ELI 150c/250c Item Identification Table

Item #	Part #	Picture
80	9910-022	
81	26025-099-151	
82	26025-105-151 (w/o COMM) 26025-105-152 (w/MODEM) 26025-105-153 (w/GSM) 26025-105-154 (w/LAN+WLAN)	 <p data-bbox="651 1501 933 1535">Example: 26025-105-151</p>
83	SERV-ASSY-177-01	

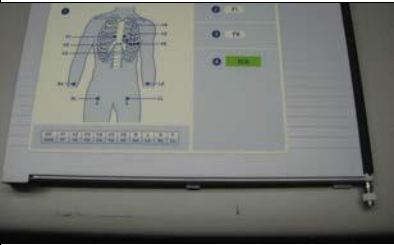
ELI 150c/250c Item Identification Table

Item #	Part #	Picture
84	SERV-ASSY-177-02	 <p>(Label not included)</p>
85	41000-028-53	
92	728427	
125	SERV-ASSY-178-02	 <p>(Label not included)</p>
126	41000-028-52	

DEVICE SPECIFICATIONS

ELI 150c Specifications

Feature	Specifications
Instrument Type	12-lead electrocardiograph
Input Channels	Simultaneous acquisition of all 12 leads
Standard Leads Acquired	I, II, III, aVR, aVL, aVF, V1, V2, V3, V4, V5, V6
Waveform Display	Backlit, ¼ VGA color LCD (320 x 240); 3, 4+4, or 6+6 lead presentation
Input Impedance Input Dynamic Range Electrode Offset Tolerance Common Mode Rejection	Meets or exceeds requirements of ANSI/AAMI EC11
Patient Leakage Current Chassis Leakage Current	Meets or exceeds requirements of ANSI/AAMI ES1
Digital Sampling Rate	40,000 s/sec/channel used for pacemaker spike detection; 1000 s/sec/channel used for recording and analysis
Special Functions	Optional Welch Allyn VERITAS resting ECG interpretation with age and gender specific algorithm; connectivity options for bidirectional communication
Paper Type	Perforated double Z-fold thermal paper; 108 mm (4") wide, 200 sheets
Thermal Printer	Computer-controlled dot array; 8 dots/mm
Thermal Printer Speeds	5, 10, 25, or 50 mm/s
Gain Settings	5, 10, or 20 mm/mV
Report Print Formats	Standard or Cabrera; 3, 3+1, 3+3, or 6 channel
Rhythm Print Formats	3 or 6 channel with configurable lead groups
Keyboard Type	Elastomeric keyboard with complete alphanumeric keys, soft-key menu, and dedicated function keys
Frequency Response	0.05 to 300 Hz
Filters	High-performance baseline filter; AC interference filter 50/60 Hz; low-pass filters 40 Hz, 150 Hz, or 300 Hz
A/D Conversion	20 bits (1.17 microvolt LSB)
Device Classification	Class I, Type CF defibrillation-proof applied parts
ECG Storage	v1.x software - Normal -100 ECGs Expanded – 200 ECGs v2.x software - Normal - 40 ECGs Expanded – 200 ECGs
Weight	7.2 lbs. (3.3 kg) including battery (without paper)
Dimensions	11.25 x 11.5 x 3.75" (29.2 x 30.5 x 10.2 cm)
Power Requirements	Universal AC power supply (100-240 VAC at 50/60 Hz) 110 VA; internal rechargeable battery

ELI 250c Specifications

Feature	Specifications
Instrument Type	12-lead electrocardiograph
Input Channels	Simultaneous acquisition of all 12 leads
Standard Leads Acquired	I, II, III, aVR, aVL, aVF, V1, V2, V3, V4, V5, V6
Waveform Display	Backlit, ¼ VGA color LCD (320 x 240); 3, 4+4, or 6+6 lead presentation
Input Impedance Input Dynamic Range Electrode Offset Tolerance Common Mode Rejection	Meets or exceeds requirements of ANSI/AAMI EC11
Patient Leakage Current Chassis Leakage Current	Meets or exceeds requirements of ANSI/AAMI ES1
Digital Sampling Rate	40,000 s/sec/channel used for pacemaker spike detection; 1000 s/sec/channel used for recording and analysis
Special Functions	Optional Welch Allyn VERITAS resting ECG interpretation with age and gender specific algorithm; connectivity options for bidirectional communication
Paper Type	Perforated Z-fold thermal paper; A4 or 8.5 x 11" wide, 250 sheets
Thermal Printer	Computer-controlled dot array; 8 dots/mm
Thermal Printer Speeds	5, 10, 25, or 50 mm/s
Gain Settings	5, 10, or 20 mm/mV
Report Print Formats	Standard or Cabrera; 3+1, 3+3, 6, 6+6, or 12 channel
Rhythm Print Formats	3, 6, or 12 channel with configurable lead groups
Keyboard Type	Elastomeric keyboard with complete alphanumeric keys, soft-key menu, and dedicated function keys
Frequency Response	0.05 to 300 Hz
Filters	High-performance baseline filter; AC interference filter 50/60 Hz; low-pass filters 40 Hz, 150 Hz, or 300 Hz
A/D Conversion	20 bits (1.17 microvolt LSB)
Device Classification	Class I, Type CF defibrillation-proof applied parts
ECG Storage	v1.x software - Normal -100 ECGs Expanded – 200 ECGs v2.x software - Normal - 40 ECGs Expanded – 200 ECGs
Weight	11.25 lbs. (5.1 kg) including battery (without paper)
Dimensions	15.5 x 17 x 4" (39.4 x 43.2 x 10.2 cm)
Power Requirements	Universal AC power supply (100-240 VAC at 50/60 Hz) 110 VA; internal rechargeable battery

TROUBLESHOOTING

System Troubleshooting Chart

LCD Message	Problem	Correction
BATTERY LOW – CHARGE UNIT	Unable to acquire ECG or unable to print.	Charge the battery with AC power.
LEAD FAULT, NO ECG CAPTURE	Lead fail or noisy ECG data.	Correct faulty lead or noise.
NO ANSWER	Unable to transmit ECG.	Check for correct phone number. Ensure modem and E-SCRIBE are online.
Date/Time will not Save	Defective Battery/Blown Fuse	Test Fuse and Battery, correct defect.

ECG Troubleshooting Chart

Affected Leads	Problem	Correction
LEADS OFF OR ONE OR MORE OF THE FOLLOWING: RA, LA, LL, V1, V2, V3, V4, V5, V6	Lead fail.	Indication of RL/RA/LA/LL/V1/V2/V3/V4/V5/V6. Check limb leads. Correct faulty lead(s).
Lead I	Missing/Noisy RA/LA.	Check patient prep; re-prep if necessary with new electrode.
Lead II	Missing/Noisy RA/LL.	Check patient prep; re-prep if necessary with new electrode.
Lead III	Missing/Noisy LA/LL.	Check patient prep; re-prep if necessary with new electrode.
All	High Freq. Noise.	Notch down filter from 300 Hz to 150 Hz; check proximity to power cables.

Transmission Troubleshooting Chart

LCD Message	Problem	Correction
TRANSMIT FAILED	Unable to transmit ECG.	Check phone line. Ensure site number is valid. Try again.
ERROR-DICOM Not Enabled	A DICOM communication was attempted, but the unit is not configured for DICOM.	Configure the system to DICOM and reboot.
UNABLE TO SAVE ECG	No available memory. ECG data too noisy to store.	Press stop to continue. Transmit or mark records for deletion in the directory. Correct noise and try acquisition/storage again.
DHCP FAILURE	The WLAN module failed to get an address from DHCP.	Contact Welch Allyn Technical Service.
DPAC FAILURE	WLAN failed to initialize.	Contact Welch Allyn Technical Service.
CAN'T CONNECT TO ACCESS POINT	A link to the access point could not be established.	Ensure the IP address is correct. If problem persists, contact Welch Allyn Technical Service.
CAN'T CONNECT TO REMOTE LINK	A link to the access point was established, but the link to the destination failed.	Ensure the IP address is correct. If problem persists, contact Welch Allyn Technical Service.

Transmission Troubleshooting Chart (continued)

LCD Message	Problem	Correction
UNABLE TO SAVE ORDER	Order storage failed.	Attempt to retransmit orders.
UNABLE TO SAVE WORK ITEM	DICOM order storage failed.	Directory full; mark records for deletion or delete records.
INCORRECT RESPONSE	Connection established, then failed.	Connection started but failed; attempt to reconnect.
NO CUSTOM ID	Received orders failed.	Previous Custom ID not compatible with current Custom ID, or no Custom ID.
PAPER QUEUE FAULT	Unable to print. Paper queue mark not detected as expected.	Add paper; manually advance page evenly past closure point of writer and close writer cover and press STOP.
CONNECTION FAILED	Unable to transmit or receive ECGs.	Check for correct baud rate, phone number, and cable connections or site number.
None	File not successfully transmitted via LAN.	Check share permissions on host device.
None	Unable to connect with LAN with crossover cable.	Implement hub vs. crossover cable.

Paper cue Fault

See Conformance Testing Section for Adjusting the Writer Cue Sensor.

Test Menu

Press F6 then Shift+ALT+x and enter the admin password.

1. Auto Test
 - a. This will test the LCD, Flash, ADC Readings and SDRAM.
2. Speaker
 - a. Tests the speaker
3. LCD Memory Test
 - a. Tests the LCD
4. Writer Test
 - a. Tst P - Prints a single sheet test
 - b. Rhy P – prints a test Rhythm page
 - c. Load – Prints all the interpretation statements – 9 pages
5. Full Keyboard Test
 - a. Tests each key individually
6. Reduced Keyboard Test
 - a. Short keyboard test
7. Configure Modem
 - a. Allows configuration of the modem if installed
8. Set Configuration

-
- a. F1 - Set to Default – Caution – erases all settings
 - b. F2 - Set to Test – Caution – erases all settings
 - c. F3 – Set Custom Config. Enters configuration menu
 - d. F5 – Erase stored ECGs
9. Stats
- a. F1 – CLR F – Clear all Flags. This will remove the Print, Transmit and Delete flags on all records
 - b. F2 – DUMP – This will copy all records to a USB flash drive without changing any flags
 - c. F3 – AQ LP – Acquire Forever Test. – Caution – This will acquire a ECG every 5 minutes. The only way to stop it is to unplug the unit from AC and remove the battery.
 - d. F4 – Fill – This will fill the directory with records based on one record in the directory.
0. Auto Test List
- a. SDRAM Test
 - b. Flash Test
 - c. ADC Reading
 - d. Checkdisk

Media – F2

This is used when the WLAN module is replaced.

CONFORMANCE TESTING

Conformance Testing

Conformance testing is to be performed by Authorized Welch Allyn Service Representatives to verify the device is functioning correctly after repair operations have been performed. Testing results should be documented on the test data record (TDR) at the end of this section of the manual. Include the following printouts: Configuration page, Writer Test, ECG, and Noise Test.

Print the device configuration (attach to the Test Data Record (TDR))

Power Testing

- Ensure battery is fully charged before performing these tests, voltage and current limits are based on a fully charged battery.
- Ensure there is no power connected to the UUT AC inlet.
- Remove upper housing and writer assembly. Disconnect battery by pulling battery cable off of the red terminal.

NOTE: Based upon customer usage and age of battery, replace as needed.

- **Note battery age** (if possible)

This information can be found on the white “date code” sticker located on the battery (use the earliest date that is not crossed out). Record Date on TDR

- **Battery (open circuit)**

Measure battery voltage using a voltage meter; verify the meter reads greater than 12.5vdc.
Record result on TDR

- **Battery (load)**

Measure the battery voltage using a volt meter and a power resistor load (10ohm, 20watt) in parallel with the battery. After approximately 5 seconds, verify the meter reads greater than 11.7vdc. Record result on TDR

- **Off current**

Connect a current meter in line with battery. With the UUT power off, verify the current meter reads less than 100 uA. Record result on TDR

- **On current**

Turn on the unit and verify the current meter reads less than 250 mA. Record result on TDR

- **AC charging current**

Apply AC power to the unit and verify that the current draw from the battery reverses polarity and the value starts decreasing as time increases. Record result on TDR

- **Battery charger output voltage**

Disconnect the current meter and measure the battery charger output voltage between the red disconnected battery cable and the negative terminal on the battery. It should read between 13.0vdc and 14.0vdc. Record result on TDR

- Verify all power cables are reconnected properly and reassemble unit.

Functional Testing

- AC LED/Display

Connect AC power cord to the unit and verify that the green AC LED (located to the left of the display) illuminates continuous.

NOTE: The battery indicator will be clear when charging and will illuminate white when fully charged.

Turn the unit on and verify the text on display is clear and legible and there are no flickering or missing lines/pixels. Record result on TDR

- Adjusting the Writer Cue Sensor

NOTE: This test should be performed with the AC power turned on. The test point, trim pot, and ground are found on the front, upper left on the keyboard (see picture below).

- 1) Install paper into the unit with the cue mark approx. 1 – 2 inches away from the tear bar. Make sure that the cue sensor is seeing white and not any markings on the paper.
- 2) Use a DMM to measure the DC voltage at test point (TP2/QSNS) on the keyboard with respect to ground (GND1). Adjust R1 V_ADJ on the keyboard to between 1.95 V-DC and 2.05 V-DC at test point P2. Set this as close to 2.0 V-DC as possible. Record result on TDR
- 3) Perform either the Writer test or print a test ECG. The paper should cue to the next sheet of paper, print and then advance to the beginning of the next sheet of paper.
- 4) If the Writer test is performed the results should be compared with the test printout in this manual.

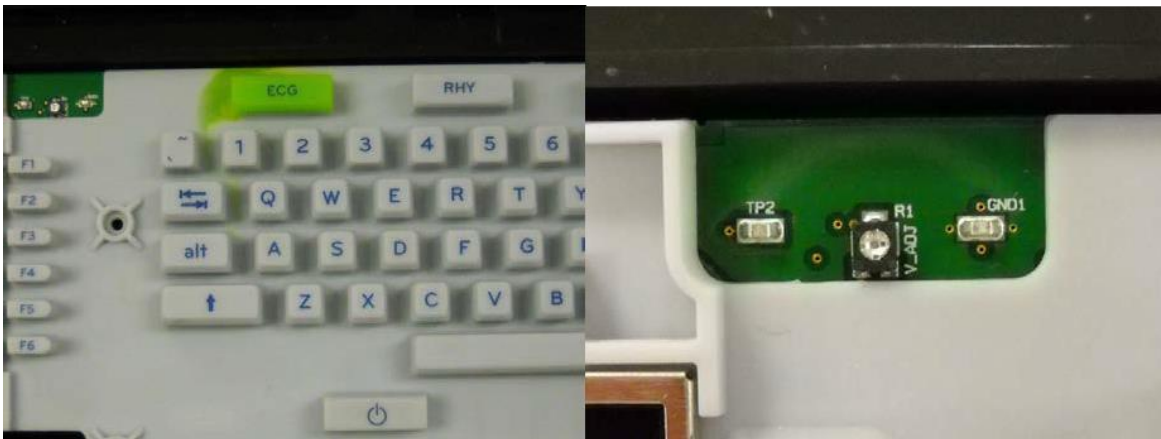

- **Writer**

Open and close the writer door to verify smooth operation. Verify that the door unlatches without sticking and that it latches completely. From the main screen, simultaneously press shift+alt+RHY. Verify that a test page is printed and the writer stops on the cue mark. The perforation of the paper should line up with the tear edge on the writer. Assure there are no gaps in the printing and the print darkness is uniform across the entire page. Verify the writer gears do not skip and paper is tracking properly (you may need to print multiple pages to observe this). Record result on TDR

- **ECG & Keyboard Matrix**

Connect an ECG simulator to the AM12 or WAM patient interface. Set the simulator to a known heart rate and amplitude. Press the ECG key to capture an ECG. Verify there is an audible beep with each key press. Enter Last name "PARCFL8" (Note: "PARCFL8" ensures the keyboard matrix is fully tested), then press F6 (Done). Verify that 12 ECG traces print correctly and assess the printout quality. Ensure uniform darkness across entire printout. Record result on TDR

- **ECG Noise Test**

Connect a Shorting Block (TF-0063) and adapter or equivalent to the AM12 or WAM patient interface. Set the ECG gain on the unit to 20mm/mV. Print a rhythm strip (approx. 1 page). Verify that no channels have more than 0.5mm of noise as measured by using Welch Allyn thermal paper (Smallest grid line = 1mm). Record result on TDR.

- **Lead Failure Test**

Connect an AM12 or WAM patient cable to the patient input of the unit, with the other end connected to a lead failure box (TF-0620 or equivalent) or patient simulator. Using the lead fail box, momentarily press each push button to open the patient leads one at a time or disconnect one lead at a time from the simulator and verify the display indicates an open lead condition for the corresponding lead. Record result on TDR

Lead Message

Right Arm - LEADS OFF

Left Arm - LA OFF

Left Leg - LL OFF

V1 - V1 OFF

V2 - V2 OFF

V3 - V3 OFF

V4 - V4 OFF

V5 - V5 OFF

V6 - V6 OFF

All Leads off - LEADS OFF

- **Communication Option Testing (as applicable)**

The receiving station for modem, LAN and WLAN transmissions should be running Welch Allyn ELI-Link software.

Refer to the ELI-Link user manual for proper configuration.

Verify successful transmission of all applicable communication options by acquiring ECG records that include the

transmission method in the “Patient Name” field (such as Last Name = USBD) then subsequently transmitting the

ECG record stored to a compatible receiving device. Consult the product user manual if needed to properly configure the communication settings for each option present on the unit under test.

Successful transmission of the test records can be verified by viewing the ECG records in the unit directory after

transmission and confirming they are marked as “transmitted” (as defined in the product user manual).

Record results on the TDR

- Modem
- LAN
- WLAN
- GSM/GPRS
- USB host (USB memory device needed)
- USBBD

Device Cleaning

Clean unit per the instructions provided in the Maintenance & Cleaning section of the service manual.

Safety Testing

If the cardiograph housing was opened for repair or inspection work, the following safety tests should be performed in accordance with the IEC 60601 standards.

The ELI150C and ELI250C are considered a Class 1 Type CF devices, intended to only be utilized with the Welch Allyn AM12 or WAM patient input modules. Defibrillation isolation from the patient is provided by the patient input modules, which are tested separately as part of the manufacturing process (they are considered non-serviceable devices), therefore Hi-pot testing is not required for these cardiograph models.

- Earth Leakage
- Enclosure Leakage
 - Non-conductive (fully insulated) chassis testing should be performed utilizing 200 cm² conductive foil or equivalent, earth ground on AC input is utilized for functional earth (not safety grounding).
- Patient Leakage
 - Applied part – patient input (utilize Welch Allyn AM12 patient cable)
- Patient Auxiliary Current
 - Applied part – patient input (utilize Welch Allyn AM12 patient cable)

ELI 150C/250C Test Data Record

Unit Serial #: _____

- Print device configuration (attach to this report)

Power Testing

Note Battery Age (If not possible enter N/A)	_____/____	(week/year)
Battery (Open Circuit) Voltage	_____ VDC	(>12.5vdc)
Battery (with Load) Voltage	_____ VDC	(>11.7vdc)
Off Current	_____ uA	(<100uA)
On Current	_____ mA	(<250mA)
AC Charging Current	PASS / FAIL	(Circle One)
Battery Charger Output Voltage	_____ VDC	(13.0-14.0vdc)

* Based upon customer usage and age of main battery, replace as needed.

- Verify all power cables are properly reconnected and reassemble unit

Functional testing

AC LED/Display Functionality	PASS / FAIL (Circle one)
Cue Sensor Calibration _____ VDC (1.95-2.05VDC)	PASS / FAIL (Circle one)
Writer Test	PASS / FAIL (Circle one)
ECG & Keyboard Matrix Testing	PASS / FAIL (Circle one)
ECG Noise Test	PASS / FAIL (Circle one)
Lead Failure Test	PASS / FAIL (Circle one)

Communication Option(s)

Modem	PASS / FAIL / NA	(Circle one)
LAN	PASS / FAIL / NA	(Circle one)
WLAN	PASS / FAIL / NA	(Circle one)
GSM/GPRS	PASS / FAIL / NA	(Circle one)
USB host	PASS / FAIL / NA	(Circle one)
USBD	PASS / FAIL / NA	(Circle one)

- Device Cleaning

Safety Testing PASS / FAIL (circle result)

Earth Leakage
Enclosure Leakage
Patient Leakage
Patient Auxiliary Current

Performed by: _____ Date: _____ / _____ / _____

ELI 150c/250c COMMUNICATION OPTIONS

Communication Options

The following Communications Options are available on the ELI150c/ELI250c:

- LAN
- WLAN
- Modem
- GSM/GPRS Mobile transmission (ELI150c Only)
- Transmission to USB Thumb-drive
- USB Mount to Windows PC (USB Device option)

Sync Media (in Settings menu):

The Sync Media can be set to the following:

- LAN + WLAN / WLAN + LAN
- LAN + GSM / GSM + LAN
- LAN + GPRS / GPRS + LAN

Sync Media will attempt a connection of the preferred method first, and if it fails or times out, will attempt the secondary mode of communication.

Communication Error Messages

DPAC Failure

This error message occurs if the DPAC fails initialization. This likely indicates a hardware problem preventing communication with the Module or a hardware problem with the Module itself.

Can't Connect To Access Point

This error message occurs if the module cannot associate with an access point. This likely indicates one of the following things: the Module's SSID is incorrect, no network with that SSID is available, the wrong security method is chosen, or the AP's configuration is incompatible with the Module.

DHCP Failure

This error message occurs if the Module failed to acquire an IP address via DHCP.

Can't Connect To Remote Link

This error message occurs if the module is able to communicate with the access point, but unable to establish a route through the network to communicate with the Remote Host. This error message may indicate the Remote Host is not ready to receive data. If the Remote Host appears to be ready, this message may indicate invalid entry of one of the following network parameters: IP address, Def. Gateway, Sub Net Mask, Host IP, or Port Number. It may also indicate that the correct security method was chosen but one or more of its required parameters were set incorrectly.

NOTE: It is possible that the Module can still transmit data with an incorrect gateway or subnet mask depending on the path through the network the data is being transmitted.

Communication Options (Software only)

- LAN
- USB (USB Device option)

Communication Options (Hardware + Software)

WLAN



GSM (150c Only)



Modem

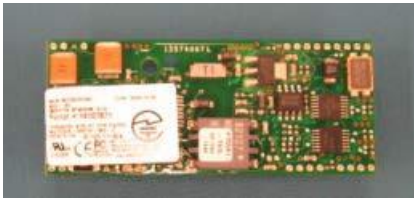

Shortcuts

Configure Transmit Media

- F6 (More)
- Shift/Alt/X
- Enter 'admin' password, Press Enter key

Directory Dump (To dump entire directory to USB thumb drive)

- F6 (More)
- F1/#1 (Directory of Stored ECG's)
- Shift/Alt/D