



Welch Allyn®
Q-Stress®
Cardiac Stress Testing System
User Manual



Manufactured by Welch Allyn, Inc. Skaneateles Falls, NY U.S.A.



CAUTION: Federal law restricts this device to sale by or on the order of a physician.

©2023 Welch Allyn This document contains confidential information that belongs to Welch Allyn, Inc. No part of this document may be transmitted, reproduced, used, or disclosed outside of the receiving organization without the express written consent of Welch Allyn, Inc. Welch Allyn, Quinton, Q-Stress, WAM and VERITAS are trademarks or registered trademarks of Welch Allyn, Inc. "SCF" (Source Consistency Filter) is a copyright of Welch Allyn, Inc. SunTech and Tango are registered trademarks of SunTech Medical, Inc. Adobe and Acrobat are registered trademarks of Adobe Systems Inc. Microsoft and Windows are registered trademarks of Microsoft Corporation. DICOM is the registered trademark of the National Electrical Manufacturers Association for its standards publications relating to digital communications of medical information.
Software V6.3.X

The information in this document is subject to change without notice.

PATENT/PATENTS

hillrom.com/patents

May be covered by one or more patents. See above Internet address. The Hill-Rom companies are the proprietors of European, US, and other patents and pending patent applications.

Hillrom Technical Support

For information about any Hillrom product, contact Hillrom Technical Support at 1.888.667.8272, mor_tech.support@hillrom.com.



80030131 Ver A
Revision date 2023-01



901144 CARDIAC STRESS TESTING SYSTEM



Welch Allyn, Inc.
4341 State Street Road
Skaneateles Falls, NY 13153 USA

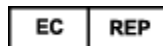

and EU IMPORTER

Welch Allyn Limited
Navan Business Park, Dublin Road
Navan, Co. Meath C15 AW22
Ireland

Authorized Australian Sponsor

1 Baxter Drive
Old Toongabbie NSW 2146
Australia

hillrom.com

Welch Allyn, Inc. is a subsidiary of Hill-Rom Holdings, Inc.



TABLE OF CONTENTS

1. NOTICES	6
MANUFACTURER’S RESPONSIBILITY	6
RESPONSIBILITY OF THE CUSTOMER	6
EQUIPMENT IDENTIFICATION	6
COPYRIGHT AND TRADEMARK NOTICES	6
OTHER IMPORTANT INFORMATION	7
NOTICE TO EU USERS AND/OR PATIENTS	7
2. WARRANTY INFORMATION	8
YOUR WELCH ALLYN WARRANTY	8
3. USER SAFETY INFORMATION	10
WARNINGS	10
CAUTIONS	13
NOTE(S)	14
4. EQUIPMENT SYMBOLS AND MARKINGS	16
DEVICE SYMBOL DELINEATION	16
PACKAGE SYMBOL DELINEATION	18
5. GENERAL CARE	19
PRECAUTIONS	19
INSPECTION	19
CLEANING AND DISINFECTING	19
CAUTIONS	20
DISPOSAL	20
6. ELECTROMAGNETIC COMPATIBILITY (EMC)	22
GUIDANCE AND MANUFACTURER’S DECLARATION: ELECTROMAGNETIC EMISSIONS	23
GUIDANCE AND MANUFACTURER’S DECLARATION: ELECTROMAGNETIC IMMUNITY	23
GUIDANCE AND MANUFACTURER’S DECLARATION: ELECTROMAGNETIC IMMUNITY	24
RECOMMENDED SEPARATION DISTANCES BETWEEN PORTABLE AND MOBILE RF COMMUNICATIONS EQUIPMENT AND THE EQUIPMENT	25
7. INTRODUCTION	26
MANUAL PURPOSE	26
AUDIENCE	26
INDICATIONS FOR USE	26
SYSTEM DESCRIPTION	27
MISCELLANEOUS SYSTEM INFORMATION	28
ABOUT THE Q-STRESS	28
Q-STRESS ECG ACQUISITION DEVICES AND ACCESSORIES	30
SUPPORTED TREADMILLS	31
SUPPORTED ERGOMETERS	31
SUPPORTED AUTOMATIC BLOOD PRESSURE DEVICES	31
Q-STRESS SOFTWARE INSTALLATION PROCESS	31
FEATURE ACTIVATION	36
STARTING THE Q-STRESS WORKSTATION	36
Q-STRESS LOGIN AND MAIN DISPLAY	36

Q-STRESS ICON DESCRIPTIONS	38
USER ROLES AND PERMISSIONS	39
Q-STRESS NETWORK OPERATION IN A DISTRIBUTED CONFIGURATION.....	40
Q-STRESS SPECIFICATIONS.....	42
UTK SPECIFICATIONS	44
PARTS AND ACCESSORIES	45
SUPPORT PARTS	46
8. MWL/PATIENTS	47
MWL	47
PATIENTS	49
9. SETUP AND INSTALLATION	50
Q-STRESS SYSTEM SETUP AND COMPONENT INSTALLATION	50
MEDICAL ISOLATION TRANSFORMER	52
Q-STRESS FRONT END AND PATIENT CABLE CONNECTION	53
Q-STRESS FRONT END AND TRIGGER MODULE CONNECTION	53
10. USING THE Q-STRESS.....	56
DEMONSTRATION MODE	59
SYSTEM DISPLAY DURING EXERCISE.....	60
TOOL BAR: EXAM PHASE BUTTONS	63
TOOL BAR: FUNCTION KEYS	64
TILES.....	67
PANELS.....	70
11. CONDUCTING A STRESS TEST.....	74
PATIENT PREPARATION	74
PATIENT HOOKUP	74
LEAD IMPEDANCE CHECK.....	77
START A STRESS TEST	78
OBSERVATION PHASE	80
PRE-EXERCISE PHASE.....	83
EXERCISE PHASE	87
RECOVERY PHASE	88
FINAL REPORT PHASE	89
QUICK START: SYSTEM SELECTION TO START A STRESS TEST	90
QUICK START: SYSTEM DISPLAY DURING THE OBSERVATION PHASE	91
QUICK START: SYSTEM DISPLAY DURING THE PRE-EXERCISE PHASE	92
QUICK START: SYSTEM DISPLAY DURING EXERCISE PHASE	93
QUICK START: SYSTEM DISPLAY DURING RECOVERY PHASE	94
QUICK START: REPORT MANAGER DISPLAY.....	95
USING REPORT MANAGER.....	96
OPEN LEGACY EXAMS.....	101
12. SYSTEM AND USER CONFIGURATION	102
ADMINISTRATION TASKS	102
MANAGE USER ACCOUNTS AND PERSONNEL.....	102
NEW USER	103
MANAGE/CREATE GROUPS	103
MODALITY SETTINGS	104
FILE EXCHANGE	110

CFD CONFIGURATION	111
DICOM AND MWL SETTINGS	111
UNLOCK EXAMS	112
MANAGE ARCHIVE STORAGE	112
AUDIT TRAIL LOGS	113
SERVICE LOGS	114
CONFIGURE WORKFLOW.....	114
USER PREFERENCES.....	115
REPORT SETTINGS.....	116
REPORT CONFIGURATION TOOL.....	117
13. EXAM SEARCH	119
ADVANCED SEARCH.....	120
14. FINAL REPORTS.....	121
PATIENT INFORMATION.....	121
EXAM SUMMARY.....	121
RATE/BP/WORKLOAD TRENDS	122
ST LEVEL TRENDS	122
ST SLOPE TRENDS.....	122
WORST CASE AVERAGE	122
PERIODIC AVERAGE.....	122
PEAK AVERAGE	123
ECG PRINTS	123
15. MAINTENANCE AND TROUBLESHOOTING	124
ROUTINE MAINTENANCE REQUIREMENTS AND CLEANING INSTRUCTIONS	124
CARE AND HANDLING OF THE OPTIONAL TOUCH MONITOR	124
CARE AND HANDLING OF THE OPTIONAL ANTIMICROBIAL KEYBOARD AND MOUSE.....	124
TROUBLESHOOTING CHART.....	125
SYSTEM INFORMATION LOG.....	127
16. PROTOCOLS.....	128
STAGE PROTOCOLS	128
LINEAR RAMP PROTOCOLS	128
BRUCE PROTOCOLS	129
17. TTL/ANALOG OUTPUT	144
TTL OUTPUT	144
ANALOG OUTPUT	144
TRIGGER MODULE ANALOG AND TTL INTERFACE PORTS	145
18. TREADMILL/ERGOMETER HOOKUP	146
Q-STRESS TO TREADMILL HOOKUP INSTRUCTIONS WITH SERIAL PORT CONNECTION	146
Q-STRESS TO ERGOMETER HOOKUP INSTRUCTIONS WITH SERIAL PORT CONNECTION	146
Q-STRESS TO TREADMILL HOOKUP INSTRUCTIONS WITH USB PORT CONNECTION	147
Q-STRESS TO ERGOMETER HOOKUP INSTRUCTIONS WITH USB PORT CONNECTION.....	147
TREADMILL REMOTE KEYPAD	148
19. CONFIGURE PRINTER.....	150
Z200+ THERMAL PRINTER	150
Z200+ THERMAL PRINTER SPECIFICATIONS	151

INPUT AND OUTPUT DESCRIPTIONS151

SETTING UP THE Z200+ THERMAL PRINTER152

MAINTAINING THE Z200+ THERMAL PRINTER.....154

CLEANING THE Z200+ THERMAL PRINTER154

TESTING PRINTER OPERATION156

POST SERVICE TESTING156

LOADING THE THERMAL PRINTER PAPER157

TROUBLESHOOTING CHART.....160

20. SUNTECH TANGO+ AND TANGO M2 INTERFACE 161

SUNTECH TANGO+ BLOOD PRESSURE (BP) MONITOR AND Q-STRESS CONNECTIONS161

TANGO+ BP MONITOR SETUP162

SUNTECH TANGO M2 BLOOD PRESSURE (BP) MONITOR AND Q-STRESS CONNECTIONS.....162

TANGO M2 BLOOD PRESSURE (BP) MONITOR SETUP164

Q-STRESS SYSTEM SETUP.....164

21. USER ROLE ASSIGNMENT TABLE 165

22. Q-STRESS DATA EXCHANGE CONFIGURATION 167

DATA EXCHANGE INTERFACES167

GLOSSARY167

NETWORK TOPOLOGIES168

DICOM170

FILE EXCHANGE175

Q-STRESS EXPORT Q-EXCHANGE XML (v3.6)176

Q-STRESS DATA IMPORT Q-EXCHANGE XML (v3.6).....180

Q-STRESS EXPORT WELCH ALLYN XML191

Q-STRESS ORDER XML200

Q-STRESS EXPORT Q-EXCHANGE XML (v1.0)202

23. Q-STRESS PHYSICIAN’S GUIDE 215

Q-STRESS SIGNAL ANALYSIS215

DATA ACQUISITION215

FULL DISCLOSURE DISPLAY AND STORAGE.....215

FINAL REPORT.....215

FILTERS.....216

BEAT IDENTIFICATION AND ACCURACY218

RESTING ECG INTERPRETATION.....218

Q-STRESS CALCULATIONS AND ALGORITHMS219

TABLE OF FIGURES

FIGURE 1 Q-STRESS SYSTEM*	29
FIGURE 2 Q-STRESS INTERCONNECT DIAGRAM	51
FIGURE 3 MEDICAL ISOLATION TRANSFORMER.....	52
FIGURE 4 ELECTRODE POSITIONING	75
FIGURE 5 Z200+ THERMAL PRINTER	150
FIGURE 6 USB Z200+ THERMAL PRINTER CONNECTORS.....	153
FIGURE 7 INTEGRATED NETWORK Z200+ THERMAL PRINTER CONNECTORS.....	153
FIGURE 8 LOADING THE THERMAL PRINTER PAPER	157
FIGURE 9 INSERT THE PAPER TRAY SPACER	158
FIGURE 10 INSERT THE PAPER TRAY SPACER.....	159

1. NOTICES

Manufacturer's Responsibility

Welch Allyn, Inc. is responsible for the effects on safety and performance only if:

- Assembly operations, extensions, readjustments, modifications, or repairs are carried out by persons authorized by Welch Allyn, Inc.
- The device is used in accordance with the instructions for use.
- The electrical installation of the relevant room complies with the requirements of appropriate regulations.

Responsibility of the Customer

The user of this device is responsible for ensuring the implementation of a satisfactory maintenance schedule. Failure to do so may cause undue failure and possible health hazards.

Equipment Identification

Welch Allyn, Inc. equipment is identified by a serial and reference number on the back of the device. Care should be taken so that these numbers are not defaced.

The Q-Stress product label is applied showing the unique identification numbers along with other important information printed on the label.

The serial number format is as follows:

YYYWWSSSSSS

YYY = First Y is always 1 followed by two-digit Year of manufacture

WW = Week of manufacture

SSSSSS = Sequence number of manufacture

The stress system product label and UDI label (when applicable) are applied to the product identification card delivered with the software.

AM12Q Module Identification

The wired Acquisition Module is identified with a product label on the back of the device and will have its own unique serial number and UDI label applied.

Wireless Module Identification

The Wireless Acquisition Module (WAM) is identified with a product label on the back of the device and has its own unique serial number and UDI label applied. When the Q-Stress system is configured for the WAM, an external UTK is included with its label showing reference number (REF) and a lot number placed on the UTK.

Copyright and Trademark Notices

This document contains information that is protected by copyright. All rights are reserved. No part of this document may be photocopied, reproduced, or translated to another language without prior written consent of Welch Allyn, Inc.

Other Important Information

The information in this document is subject to change without notice.

Welch Allyn, Inc. makes no warranty of any kind with regard to this material including, but not limited to, implied warranties of merchantability and fitness for a particular purpose. Welch Allyn, Inc. assumes no responsibility for any errors or omissions that may appear in this document. Welch Allyn, Inc. makes no commitment to update or to keep current the information contained in this document.

Notice to EU Users and/or Patients

Any serious incident that has occurred in relation to the device, should be reported to the manufacturer and the competent authority of the Member State in which the user and/or patient is established.

2. WARRANTY INFORMATION

Your Welch Allyn Warranty

WELCH ALLYN, INC. (hereafter referred to as “Welch Allyn”) warrants that components within Welch Allyn products (hereafter referred to as “Product/s”) will be free from defects in workmanship and materials for the number of years specified on documentation accompanying the product, or previously agreed to by the purchaser and Welch Allyn, or if not otherwise noted, for a period of twelve (12) months from the date of shipment.

Consumable, disposable or single use products such as, but not limited to, PAPER or ELECTRODES are warranted to be free from defects in workmanship and materials for a period of 90 days from the date of shipment or the date of first use, whichever is sooner.

Reusable product such as, but not limited to, BATTERIES, BLOOD PRESSURE CUFFS, BLOOD PRESSURE HOSES, TRANSDUCER CABLES, Y-CABLES, PATIENT CABLES, LEAD WIRES, MAGNETIC STORAGE MEDIUMS, CARRY CASES or MOUNTS, are warranted to be free from defects in workmanship and materials for a period of 90 days. This warranty does not apply to damage to the Product/s caused by any or all of the following circumstances or conditions:

- a) Freight damage;
- b) Parts and/or accessories of the Product/s not obtained from or approved by Welch Allyn;
- c) Misapplication, misuse, abuse, and/or failure to follow the Product/s instruction sheets and/or information guides;
- d) Accident; a disaster affecting the Product/s;
- e) Alterations and/or modifications to the Product/s not authorized by Welch Allyn;
- f) Other events outside of Welch Allyn’s reasonable control or not arising under normal operating conditions.

THE REMEDY UNDER THIS WARRANTY IS LIMITED TO THE REPAIR OR REPLACEMENT WITHOUT CHARGE FOR LABOR OR MATERIALS, OR ANY PRODUCT/S FOUND UPON EXAMINATION BY WELCH ALLYN TO HAVE BEEN DEFECTIVE. This remedy shall be conditioned upon receipt of notice by Welch Allyn of any alleged defects promptly after discovery thereof within the warranty period. Welch Allyn’s obligations under the foregoing warranty will further be conditioned upon the assumption by the purchaser of the Product/s (i) of all carrier charges with respect to any Product/s returned to Welch Allyn’s principal place or any other place as specifically designated by Welch Allyn or an authorized distributor or representative of Welch Allyn, and (ii) all risk of loss in transit. It is expressly agreed that the liability of Welch Allyn is limited and that Welch Allyn does not function as an insurer. A purchaser of a Product/s, by its acceptance and purchase thereof, acknowledges and agrees that Welch Allyn is not liable for loss, harm, or damage due directly or indirectly to an occurrence or consequence therefrom relating to the Product/s. If Welch Allyn should be found liable to anyone under any theory (except the expressed warranty set forth herein) for loss, harm, or damage, the liability of Welch Allyn shall be limited to the lesser of the actual loss, harm, or damage, or the original purchase price of the Product/s when sold.

EXCEPT AS SET FORTH HEREIN WITH RESPECT TO REIMBURSEMENT OF LABOR CHARGES, A PURCHASER'S SOLE EXCLUSIVE REMEDY AGAINST WELCH ALLYN FOR CLAIMS RELATING TO THE PRODUCT/S FOR ANY AND ALL LOSSES AND DAMAGES RESULTING FROM ANY CAUSE SHALL BE THE REPAIR OR REPLACEMENT OF DEFECTIVE PRODUCT/S TO THE EXTENT THAT THE DEFECT IS NOTICED AND WELCH ALLYN IS NOTIFIED WITHIN THE WARRANTY PERIOD. IN NO EVENT, INCLUDING THE CLAIM FOR NEGLIGENCE, SHALL WELCH ALLYN BE LIABLE FOR INCIDENTAL, SPECIAL, OR CONSEQUENTIAL DAMAGES, OR FOR ANY OTHER LOSS, DAMAGE, OR EXPENSE OF ANY KIND, INCLUDING LOSS OF PROFITS, WHETHER UNDER TORT, NEGLIGENCE OR STRICT LIABILITY THEORIES OF LAW, OR OTHERWISE. THIS WARRANTY IS EXPRESSLY IN LIEU OF ANY OTHER WARRANTIES, EXPRESS OR IMPLIED, INCLUDING, BUT NOT LIMITED TO THE IMPLIED WARRANTY OF MERCHANTABILITY AND THE WARRANTY OF FITNESS FOR A PARTICULAR PURPOSE.

3. USER SAFETY INFORMATION



WARNING: Means there is the possibility of personal injury to you or others.



Caution: Means there is the possibility of damage to the device.

Note: Provides information to further assist in the use of the device.

***NOTE:** This manual may contain screen shots and pictures. Any screen shots and pictures are provided for reference only and are not intended to convey actual operating techniques. Consult the actual screen in the host language for specific wording.*



WARNINGS

1. This manual gives important information about the use and safety of this device. Deviating from operating procedures, misuse or misapplication of the device, or ignoring specifications and recommendations could result in increased risk of harm to users, patients and bystanders, or damage to the device.
2. The various manufacturers of accessories provide separate user manuals and/or instructions (e.g., display, blood pressure monitor, laser printer, patient cables, and electrodes). Read these instructions well and refer to them for specific functions. It is recommended to keep all instructions together. Refer to these instructions for a list of approved accessories. When in doubt, contact Welch Allyn.
3. Device (cardiac stress system) captures and presents data reflecting a patient's physiological condition that when reviewed by a trained physician or clinician can be useful in determining a diagnosis; however, the data should not be used as a sole means for determining a patient's diagnosis.
4. Users are expected to be licensed clinical professionals knowledgeable about medical procedures and patient care, and adequately trained in the use of this device. Before attempting to use this device for clinical applications, the operator must read and understand the contents of the user manual and other accompanying documents. Inadequate knowledge or training could result in increased risk of harm to users, patients and bystanders, or damage to the device. Contact Welch Allyn service for additional training options.
5. To ensure that electrical safety is maintained during operation from AC (~) power, the device must be plugged into a hospital-grade outlet.
6. The device is supplied with a power isolation transformer that must be used to maintain designed operator and patient isolation from power source. The power isolation transformer must be plugged into a hospital-grade outlet.
7. To maintain designed operator and patient safety, peripheral equipment and accessories used that can come in direct patient contact must be in compliance with ANSI/AAMI ES 60601-1, IEC 60601-1, and IEC 60601-2-25. Only use parts and accessories supplied with the device and available through Welch Allyn, Inc.
8. All signal input and output (I/O) connectors are intended for connection of only those devices complying with IEC 60601-1, or other IEC standards (e.g., IEC 60950-1, IEC 62368-1), as appropriate to the device. Connecting additional devices to the device may increase chassis and/or patient leakage currents. To maintain operator and patient safety, consideration should be given to the requirements of IEC 60601-1 Clause 16, and leakage currents should be measured to confirm no electric shock hazard exists.

9. To avoid potential for electric shock, ensure that approved equipment and accessories are connected to the appropriate ports and that no incompatible equipment has been connected.
10. Patient cables intended for use with the device include series resistance (9 Kohm minimum) in each lead for defibrillation protection. Patient cables should be checked for cracks or breakage prior to use.
11. Conductive parts of the patient cable, electrodes, and associated connections of Type CF applied parts, including the neutral conductor of the patient cable and electrode should not come into contact with other conductive parts, including earth ground.
12. Conductive parts of the SunTech® Tango® blood pressure monitor's optional pulse oximeter (SpO₂ sensor used to monitor oxygen saturation) and associated connections of Type BF applied parts should not come into contact with other conductive parts, including earth ground. The pulse oximeter is not defibrillator protected. Refer to the SunTech Tango user instructions for further details.
13. To avoid risk of improper electrical isolation the Tango SpO₂ sensor must only be connected to the proper SpO₂ extension patient cable or port on the SunTech Tango blood pressure monitor.
14. The personal computer and all peripheral equipment used should be approved to the appropriate safety standard for nonmedical electrical equipment per IEC 60950-1, IEC 62368-1, or their national variants.
15. If there is a requirement for the personal computer or any peripheral equipment connected to it, including exercise equipment like an ergometer or treadmill to be situated within the patient environment it is the responsibility of the user to ensure the system provides a level of safety that ensures compliance with IEC 60601-1, Clause 16. Non-medical equipment should be powered through a medical grade isolation transformer of sufficient capacity, and should comply with the relevant IEC Standard (e.g.; IEC 60950-1, IEC 62368-1)..
16. Position the system in a location where the isolation transformer medical grade power cord plug can be quickly disconnected from the power source should it become necessary to isolate the cardiac stress system from the supply mains.
17. To avoid the possibility of serious injury or death during patient defibrillation, do not come into contact with device or patient cables. Additionally, proper placement of defibrillator paddles in relation to the electrodes is required to minimize harm to the patient.
18. Proper clinical procedure must be employed to prep the electrode sites and to monitor the patient for excessive skin irritation, inflammation, or other adverse reactions. Electrodes are intended for short term use and should be removed from the patient promptly following testing.
19. To avoid potential for spread of disease or infection, single-use disposable components (e.g., electrodes) must not be reused. To maintain safety and effectiveness, electrodes must not be used beyond their expiration date.
20. A possible explosion hazard exists. Do not use the device in the presence of a flammable anesthetic mixture.
21. The device has not been designed for use with high-frequency (HF) surgical equipment and does not provide a protective means against hazards to the patient.
22. When the 40 Hz filter is used, the frequency response requirement for diagnostic ECG equipment cannot be met. The 40 Hz filter significantly reduces high-frequency components of the ECG and pacemaker spike amplitudes, and is recommended only if high-frequency noise cannot be reduced by proper procedures.

23. Test Q-Stress functions after each Microsoft critical and security update. Instructions for testing the system functions are located in the Q-Stress System Installation Manual, part number 9515-205-60-ENG.
24. To maintain designed operator and patient safety, the Q-Stress Front End, and conductive portions of connected cables must be positioned such that they are inaccessible during normal operation.
25. An additional Multiple Plug Socket Outlet (MPSO) or extension cord shall not be connected to the system.
26. Do not connect any items which are not specified as part of the system.
27. The quality of the signal produced by the thermal writer may be adversely affected by the use of other medical equipment, including but not limited to defibrillators and ultrasound machines.
28. ECG electrodes could cause skin irritation; patients should be examined for signs of irritation or inflammation. Electrode materials and ingredients are specified on the packaging or are available from the vendor upon request.
29. Do not attempt to clean the device or patient cables by submersing into a liquid, autoclaving, or steam cleaning as this may damage equipment or reduce its usable life. Wipe the exterior surfaces with a warm water and mild detergent solution and then dry with a clean cloth. Use of unspecified cleaning/disinfecting agents, failure to follow recommended procedures, or contact with unspecified materials could result in increased risk of harm to users, patients and bystanders, or damage to the device.
30. No user-serviceable parts inside. Screw removal by qualified service personnel only. Damaged or suspected inoperative equipment must be immediately removed from use and must be checked/repared by qualified service personnel prior to continued use.
31. Damaged or suspected inoperative equipment must be immediately removed from use and must be checked/repared by qualified service personnel prior to continued use.
32. To prevent emission of substances that may damage the environment, dispose of the device, its components and accessories (e.g., batteries, cables, electrodes), and/or packing materials that are past the shelf life in accordance with local regulations.
33. When necessary, dispose of the device, its components and accessories (e.g., batteries, cables, electrodes), and/or packing materials in accordance with local regulations.
34. To maintain a safe working environment, the cardiac stress cart including devices and equipment should not exceed 200 kg.
35. Proper functioning backup items such as a spare patient cable, display monitor, and other equipment are recommended on hand to prevent delayed treatment due to an inoperable device.
36. The device and IT Network the device is connected to should be securely configured and maintained per the IEC 80001 standard, or an equivalent network security standard or practice.
37. This product complies with relevant electro-magnetic interference, mechanical safety, performance, and biocompatibility standards. However, the product cannot completely eliminate potential patient or user harm from the following:
 - Harm or device damage associated with electro-magnetic hazards,
 - Harm from mechanical hazards,
 - Harm from device, function, or parameter unavailability,
 - Harm from misuse error, such as inadequate cleaning, and/or
 - Harm from device exposure to biological triggers that may result in a severe systemic allergic reaction



Cautions

1. Do not use the device as a method for loading or operating commercially available software. Doing so might affect the performance of the device.
2. Do not pull or stretch patient cables as this could result in mechanical and/or electrical failures. Patient cables should be stored after forming them into a loose loop.
3. Microsoft Windows updates and anti-virus policy: Although it is unlikely that Windows updates and security patches affect Q-Stress functionality, Welch Allyn recommends turning automatic Windows update off, and periodically running it manually. A functional test should be executed after update, which includes conducting an exam, as well as importing an order and exporting results, if activated. Welch Allyn recommends excluding the Q-Stress database folder (normally C:\ProgramData\MiPgSqlData on a stand-alone system or the server) and main application folder (normally C:\Program Files (x86)\Mortara Instrument Inc\ModalityMgr) from the folders to be scanned. In addition, anti-virus patch updates and system scans should be scheduled for time periods when the system is not actively in use or performed manually.
4. No other non-recommended PC application software should be running while the Q-Stress application is being used.
5. It is recommended that all cardiac stress workstations and review stations be periodically updated with Microsoft critical and security updates to protect from malware attacks and to fix critical Microsoft software issues.
6. To prevent delivery of malware into the system Welch Allyn recommends that institution operating procedures are written to prevent malware to be transmitted into the system from removable media.
7. Exams that are saved to the local or server database on the hard drive will cause the device to fill over a period of time. These exams must be removed from the database by deleting or archiving prior to causing the device to cease to operate. Periodic checks of the device's capacity are recommended; a safe minimum capacity is 3 GB. See [Exam Search](#) for ways to select exams for deletion or archiving.
8. The Q-Stress application will display a warning prompting the user to delete exams when the database reaches a threshold at 3.2 GB of available space. Each stress exam is approximately 40 MB in size and only 30 more exams can be started. When the available storage is at 2 GB, no new stress exams can be started.
9. To avoid risk of unintentionally booting into a USB device, ensure that the Boot Order in BIOS is set with the SATA hard drive listed first in the boot order. Refer to computer manufacturer's instruction for entering BIOS on startup and configuring Boot Order.
10. The WAM will only work with receiving devices that are equipped with the appropriate option.
11. This WAM is not recommended for use in the presence of imaging equipment such as Magnetic Resonance Imaging (MRI) and Computed Tomography (CT) devices, etc.
12. The following equipment may cause interference with the WAM RF channel: microwave ovens, diathermy units with LANs (spread spectrum), amateur radios, and government radar.
13. When necessary, dispose of the device, its components and accessories (e.g., batteries, cables, electrodes), and/or packing materials in accordance with local regulations.

14. AA batteries are known to leak their contents when stored in unused equipment. Remove battery from WAM when not used for an extended period of time.
15. Be careful to insert the connector block into the appropriate input connector by matching the lead wire labels to the WAM.

Note(s)

1. Local Administrator permissions are required for software installation, application configuration, and software activation. Local User privileges are required for application users. Roaming and temporary accounts are not supported.
2. 8-hour timeout expiration is automatically controlled by the system. Each operation that occurs (e.g. Exam Search, Patient Search, editing exams, starting an exam, etc.) will reset the timeout start time. When there is no interaction with the system for the timeout duration, the user is prompted to enter login information.
3. When the server is unavailable in a distributed configuration, the client workstation will notify the user with a prompt to proceed in Offline Mode or cancel. Scheduled orders are not available. An exam can be conducted with manually entered demographics and will be stored locally. When the server comes available, the user is prompted with a list of unsent exams and a selection to send exams to the modality manager database.
4. Once the Pre-Exercise phase is started, full disclosure data storage begins and will continue for up to 120-minutes. It is recommended to Abort the exam and Begin again if waiting in this phase for up to 60-minutes. This prevents unnecessary data storage, however previously stored full disclosure, ECG events, and BP values are not saved when the exam is aborted.
5. Patient movements may generate excessive noise that may affect the quality of the ECG traces and the proper analysis performed by the device.
6. Proper patient preparation is important to proper application of ECG electrodes and operation of the device.
7. The Beat Consistency Filter (BCF) that produces averaged 12-lead ECG printout introduces an additional two-second delay to the real-time ECG data when enabled.
8. There is no known safety hazard if other equipment, such as pacemakers or other stimulators, is used simultaneously with the device; however, disturbance to the signal may occur.
9. If the treadmill COM port was originally set to a USB port that was not used, a TREADMILL FAIL message will appear when the Trackmaster (No Sensing) selection is made in the Local Settings menu. When the COM port is set to Treadmill COM Port 1 or 2, which are serial ports, there will be no TREADMILL FAIL message.
10. If electrode is not properly connected to the patient, or one or more of the patient cable lead wires is damaged, display will indicate a lead fault for the lead(s) where the condition is present.
11. As defined by IEC 60601-1 the device is classified as follows:
 - Class I equipment
 - Type CF, defibrillation-proof applied parts (ECG inputs)
 - Tango BP monitor type BF, defibrillation-proof applied parts with exception of the optional pulse oximeter that is not defibrillation-proof
 - Ordinary equipment
 - Equipment not suitable for use in the presence of a flammable anesthetic mixture
 - Continuous operation

NOTE: From a safety perspective, per IEC 60601-1 and derivative standards/norms, this unit is declared to be "Class I" and uses a three-prong inlet to ensure an earth connection is made along with mains.

12. To prevent possible damage to the device during transport and storage (while in original packaging) the following environmental conditions must be adhered to:
 - Ambient temperature: -40° C to 65° C (-40° F to 149° F)
 - Relative humidity: 8% to 80%, non-condensing
13. Allow the device to stabilize within its intended operating environment for a minimum of two hours prior to use. Refer to the computer and peripheral equipment user manuals for allowable environmental conditions. The allowable environmental conditions for the Q-Stress Front End and Trigger Module are as follows:
 - Ambient temperature: 10° C to 35° C (50° F to 95° F)
 - Relative humidity: 8% to 80%, non-condensing
14. The display of absent waveform while using the WAM wireless acquisition module could be due to the WAM being turned off or having no battery, or the WAM being out of range or experiencing a calibration error. Ensure the WAM is paired correctly and is within recommended proximity of the UTK receiver, and/or power cycle the WAM to re-calibrate. ****RF Synch Fail**** message will also be displayed.
15. A square wave on the display and rhythm printout could be due to the lead wires not being connected to the patient.
16. The WAM must be paired to the Q-Stress system before operation.
17. If the WAM battery cover is opened during transmission, the device will stop transmitting. The battery must be reinserted and the cover must be applied to resume operation.
18. The WAM will automatically turn off (LEDs off) if the battery has been severely discharged.
19. The WAM will automatically power off after the exam has ended.
20. The WAM Rhythm Print and 12-Lead ECG buttons are non- functional.
21. The Q-Stress Cardiac Stress Testing System is UL classified:



AAMI ES 60601-1(2012),
 CAN/CSA C22.2 No. 60601-1(2014),
 IEC 60601-1(2012), IEC 60601-2-25(2011)

4. EQUIPMENT SYMBOLS AND MARKINGS

Device Symbol Delineation



WARNING The warning statements in this manual identify conditions or practices that could lead to illness, injury, or death. In addition, when used on a patient applied part, this symbol indicates defibrillation protection is in the cables. Warning symbols will appear with a grey background in a black and white document



CAUTION The caution statements in this manual identify conditions or practices that could result in damage to the equipment or other property, or loss of data



Follow instructions/directions for use (DFU) -- mandatory action. A copy of the DFU is available on this website. A printed copy of the DFU can be ordered from Hillrom for delivery within 7 calendar days.



Protective earth



Fuse



Defibrillator-proof type CF applied part

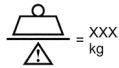

Equipment mass including safe working load



Input

ECG A

ECG A input connection



ECG B

ECG B input connection



Output

















TTL Signal Output connection



1

Analog Signal 1 Output connection

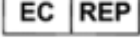

2 	Analog Signal 2 Output connection
3 	Analog Signal 3 Output connection
	USB connection
PC 	USB connection to PC
	AC (alternating current)
	Printer out of paper or paper error condition
	Advances paper to the next paper perforation and will reset a paper error condition. When depressed for approximately 7 seconds, will reset the device
 	Do not dispose as unsorted municipal waste. Requires separate handling for waste disposal according to local requirements as per 2012/19/EU.
	Indicates compliance to applicable European Union directives
	Medical Device
	Model Identifier
	Reorder Number
	Serial Number
	Manufacturer
	Authorized representative in the European Community

NOTE: Refer to the manual(s) accompanying the device that pertain to the computer hardware for additional definitions of symbols that may be present

Package Symbol Delineation



This side up



Fragile



Keep Dry



Keep Away from Heat

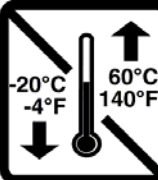

Acceptable Temperature Range



Contains Non-spillable Battery

5. GENERAL CARE

Precautions

- Turn off the device before inspecting or cleaning.
- Do not immerse the device in water.
- Do not use organic solvents, ammonia based solutions, or abrasive cleaning agents which may damage equipment surfaces.

Inspection

Inspect your equipment daily prior to operation. If you notice anything that requires repair, contact an authorized service person to make the repairs.

- Verify that all cords and connectors are securely seated.
- Check the case and chassis for any visible damage.
- Inspect cords and connectors for any visible damage.
- Inspect keys and controls for proper function and appearance.

Cleaning and Disinfecting

Disinfecting agents

The Q-Stress, including the ECG acquisition module, is compatible with the following disinfectants:

- Clorox Healthcare[®] Bleach Germicidal Wipes (use according to instructions on product label), or
- a soft, lint-free cloth dampened with a solution of sodium hypochlorite (10% household bleach and water solution) minimum 1:500 dilution (minimum 100 ppm free chlorine) and maximum 1:10 dilution as recommended by the APIC Guidelines for Selection and Use of Disinfectants.



Caution: Disinfecting or cleaning agents that contain Quaternary Ammonium Compounds (Ammonium Chlorides) have been identified as having negative effects if used to disinfect the product. Use of such agents may result in discoloration, cracking, and deterioration of the external housing of the device.

Cleaning

To clean the Q-Stress:

1. Disconnect the power source.
2. Remove cables and lead wires from device before cleaning.
3. Thoroughly wipe the surface of the Q-Stress system with a clean, lint-free cloth dampened with a mild detergent and water for general cleaning or use one of the above recommended agents for disinfection.
4. Dry the device with a clean, soft, dry, lint-free cloth.

**WARNING:**

Prevent liquid from penetrating the device and do not attempt to clean/disinfect the device or patient cables by submerging into a liquid, autoclaving, or steam cleaning.

Do not expose cables to strong ultra-violet radiation.

Do not immerse cable ends or lead wires; immersion can cause metal corrosion. Use caution with excess liquid as contact with metal parts may cause corrosion.

Do not use excessive drying techniques such as forced heat.

Improper cleaning products and processes can damage the device, produce brittle lead wires and cables, corrode the metal, and void the warranty. Use care and proper procedure whenever cleaning or maintaining the device.

The stress belt can be surface cleaned with a damp cloth or a disinfectant wipe or spray. The stress belt may also be machine or hand washed with detergent and air dried. Do not machine dry the stress belt. Cosmetic changes may occur during washing. Inspect stress belts for structural damage after each washing cycle and replace when necessary.

Cautions

Improper cleaning products and processes can damage the device, produce brittle lead wires and cables, corrode the metal, and void the warranty. Use care and proper procedure whenever cleaning or maintaining the device.

Disposal

Disposal must be in accordance with the following steps:

1. Follow cleaning and disinfection instructions per instructions in this user manual section.
2. Delete all existing data related to patients/hospital/clinic/doctor. Data backup may be performed prior to deletion.
3. Segregate material in preparation for the recycling process
 - Components are to be disassembled and recycled based on type of material
 - Plastic to be recycled as plastic waste
 - Metal to be recycled as Metals
 - Includes loose components containing more than 90% metal by weight
 - Includes screws and fasteners
 - Electronic components, including the power cord, to be disassembled and recycled as Waste of Electrical and Electronic Equipment (WEEE)
 - Batteries to be dismantled from the device and recycled as per WEEE

Users must adhere to all federal, state, regional, and/or local laws and regulations as it pertains to the safe disposal of medical devices and accessories. If in doubt, the user of the device shall first contact Hillrom Technical Support for guidance on safe disposal protocols.



Waste of Electrical and
Electronic Equipment (WEEE)

6. ELECTROMAGNETIC COMPATIBILITY (EMC)

Electromagnetic compatibility with surrounding devices should be assessed when using the device.

An electronic device can either generate or receive electromagnetic interference. Testing for electromagnetic compatibility (EMC) has been performed on the device according to the international standard for EMC for medical devices (IEC 60601-1-2). This IEC standard has been adopted in Europe as the European Norm (EN 60601-1-2).

The system should not be used adjacent to, or stacked on top of other equipment. If the device must be used adjacent to or stacked on top of other equipment, verify that the device (and optional thermal writer) operates in an acceptable manner in the configuration in which it will be used.

Fixed, portable, and mobile radio frequency communications equipment can affect the performance of medical equipment. See the appropriate EMC table for recommended separation distances between the radio equipment and the device.

The use of accessories, transducers and cables other than those specified by Welch Allyn may result in increased emissions or decreased immunity of the system.

Guidance and Manufacturer's Declaration: Electromagnetic Emissions

The equipment is intended for use in the electromagnetic environment specified in the table below. The customer or the user of the equipment should ensure that it is used in such an environment.

Emissions Test	Compliance	Electromagnetic Environment: Guidance
RF Emissions CISPR 11	Group 1	The equipment uses RF energy only for its internal function. Therefore, its RF emissions are very low and not likely to cause any interference in nearby electronic equipment.
RF Emissions CISPR 11	Class A	The equipment is suitable for use in all establishments other than domestic and those directly connected to the public low-voltage power supply network that supplies buildings used for domestic purposes.
Harmonic Emissions IEC 61000-3-2	Complies	
Voltage Fluctuations/ Flicker Emissions IEC 61000-3-3	Complies	

Guidance and Manufacturer's Declaration: Electromagnetic Immunity

The equipment is intended for use in the electromagnetic environment specified in the table below. The customer or the user of the equipment should ensure that it is used in such an environment.

Immunity Test	Compliance	Compliance Level	Electromagnetic Environment: Guidance
Electrostatic discharge (ESD) IEC 61000-4-2	+/- 6 kV contact +/- 8 kV air	+/- 6 kV contact +/- 8 kV air	Floors should be wood, concrete, or ceramic tile. If floors are covered with synthetic material, the relative humidity should be at least 30%.
Electrical fast transient/burst IEC 61000-4-4	+/- 2 kV for power supply lines +/- 1 kV for input/output lines	+/- 2 kV for power supply lines +/- 1 kV for input/output lines	Mains power quality should be that of a typical commercial or hospital environment.
Surge IEC 61000-4-5	+/- 1 kV differential mode +/- 2 kV common mode	+/- 1 kV differential mode +/- 2 kV common mode	Mains power quality should be that of a typical commercial or hospital environment.
Voltage dips, short interruptions, and voltage variations on power supply input lines IEC 61000-4-11	<5% UT (>95% dip in UT) for 0.5 cycle 40% UT (60% dip in UT) for 5 cycles	<5% UT (>95% dip in UT) for 0.5 cycle 40% UT (60% dip in UT) for 5 cycles	Mains power quality should be that of a typical commercial or hospital environment. If the user of the equipment requires continued operation during power mains interruptions, it is recommended that the equipment be powered from an uninterruptible power supply or a battery
Power frequency (50/60 Hz) magnetic field	3 A/m	3 A/m	Power frequency magnetic fields should be at levels characteristic of a typical location in a typical commercial or hospital environment.

NOTE: UT is the AC Mains voltage prior to application of the test level.

Guidance and Manufacturer's Declaration: Electromagnetic Immunity

The equipment is intended for use in the electromagnetic environment specified in the table below. The customer or the user of the equipment should ensure that it is used in such an environment.

Immunity Test	IEC 60601 Test Level	Compliance Level	Electromagnetic Environment: Guidance
Conducted RF IEC 61000-4-6	3 Vrms 150 kHz to 80 MHz	3 Vrms 150 kHz to 80 MHz	<p>Portable and mobile RF communications equipment should be used no closer to any part of the equipment, including cables, than the recommended separation distance calculated from the equation applicable to the frequency of the transmitter.</p> <p>Recommended separation distance</p> $d = \left[\frac{3.5}{3V_{rms}} \right] \sqrt{P}$ $d = \left[\frac{3.5}{3V/m} \right] \sqrt{P} \quad 80 \text{ MHz to } 800 \text{ MHz}$ $d = \left[\frac{7}{3V/m} \right] \sqrt{P} \quad 800 \text{ MHz to } 2.5 \text{ GHz}$ <p>Where P is the maximum output power rating of the transmitter in watts (W) according to the transmitter manufacturer and d is the recommended separation distance in meters (m).</p> <p>Field strengths from fixed RF transmitters, as determined by an electromagnetic site survey^a, should be less than the compliance level in each frequency range^b.</p> <p>Interference may occur in the vicinity of equipment marked with the following symbol:</p> 
Radiated RF IEC 61000-4-3	3 V/m 80 MHz to 2.5 GHz	3 V/m 80 MHz to 2.5 GHz	

- a. Field strengths from fixed transmitters, such as base stations for radio (cellular/cordless) telephones and land mobile radios, amateur radios, AM and FM radio broadcast, and TV broadcast cannot be predicted theoretically with accuracy. To assess the electromagnetic environment due to fixed RF transmitters, an electromagnetic site survey should be considered. If the measured field strength in the location in which the equipment is used exceeds the applicable RF compliance level above, the equipment should be observed to verify normal operation. If abnormal performance is observed, additional measures may be necessary, such as reorienting or relocating the equipment.
- b. Over the frequency range 150 kHz to 80 MHz, field strengths should be less than [3] V/m.

Recommended Separation Distances Between Portable and Mobile RF Communications Equipment and the Equipment

The equipment is intended for use in the electromagnetic environment in which radiated RF disturbances are controlled. The customer or the user of the equipment can help to prevent electromagnetic interference by maintaining a minimum distance between portable and mobile RF communications equipment (transmitters) and the equipment as recommended in the table below, according to the maximum output power of the communications equipment.

Rated Maximum Output Power of Transmitter W	Separation Distance According to Frequency of Transmitter (m)	
	150 KHz to 800 MHz	800 MHz to 2.5 GHz
	$d = 1.2\sqrt{P}$	$d = 2.3\sqrt{P}$
0.01	0.1 m	0.2 m
0.1	0.4 m	0.7 m
1	1.2 m	2.3 m
10	4.0 m	7.0 m
100	12.0 m	23.0 m

For transmitters rated at a maximum output power not listed above, the recommended separation distance d in meters (m) can be estimated using the equation applicable to the frequency of the transmitter, where P is the maximum output power rating of the transmitter in watts (W) according to the transmitter manufacturer.

NOTE 1: At 800 MHz, the separation distance for the higher frequency range applies.

NOTE 2: These guidelines may not apply in all situations. Electromagnetic propagation is affected by the absorption and reflection from structures, objects, and people.

7. INTRODUCTION

Manual Purpose

This manual is intended to provide the user with information about:

- [Using the Schedule/Orders icon.](#)
- [Q-Stress® stress exercise system setup and installation.](#)
- [Using the Q-Stress system.](#)
- [Patient preparation and conducting a stress test.](#)
- [Configuring the Q-Stress.](#)
- [Using Exam Search.](#)
- [Final Reports.](#)
- [Maintenance and troubleshooting.](#)
- [Protocols.](#)
- [TTL and analog output.](#)
- [Treadmill/ergometer hookup.](#)
- [Configuring and using the Z200+ thermal printer.](#)
- [Configuring the SunTech Tango monitor interface](#)

NOTE: This manual may contain screen shots. Screen shots are provided for reference only and are not intended to convey actual operating techniques. Consult the actual screen in the host language for specific wording.

Audience

This manual is written for clinical professionals. They are expected to have working knowledge of medical procedures and terminology as required for monitoring cardiac patients.

Indications for Use

The Q-Stress device is intended to acquire, process, record, archive, analyze, and output electrocardiographic data during physiologic stress testing. The device is intended for use in adult, adolescent, and children patient populations. The device is intended for use in a clinical setting by trained personnel under the supervision of a licensed physician.

The device may interface with equipment for pulmonary function testing and other devices, including a treadmill or ergometer for dynamic exercise evaluation, as well as non-invasive blood pressure equipment, functional arterial oxygen saturation (SpO2) equipment, and computer communications equipment.

The device is not intended to be used as a vital signs physiological monitor.

System Description

Q-Stress is a diagnostic device capable of real time ECG display, heart rate measurement, ST analysis and ventricular ectopic beat detection using wired or wireless acquisition modules. The device is able to generate risk scoring via recognized protocols. The device is capable of obtaining a resting ECG with automatic interpretation. The device can interface with equipment for pulmonary evaluation. The device has several built in exercise protocols for connection and control of exercise equipment such as treadmills and ergometers. The device supports measurement of non-invasive blood pressure. The device can output analog ECG signals or digital QRS trigger signals for synchronizing an external device. The device supports a touch screen interface as well as a keyboard / mouse interface and a wired remote control unit. The device will store a complete record of diagnostic quality test data from which the user can generate and review stress test reports. The device can function as standalone workstation or can connect via network to a database server allowing for remote review capabilities. The device can communicate with electronic record keeping systems to obtain work lists and patient data, and to provide test result reports.

The interpretive portion of the ECG is available in the pre-exercise portion of the test. For additional information on the VERITAS™ algorithm, please refer to the *Physician's Guide to VERITAS with Adult and Pediatric Resting ECG Interpretation*. (See [Parts and Accessories](#).)

The system includes a demonstration mode that provides a way to demonstrate system features and train clinicians on operation without the need for live physiological data. Refer to [Demonstration Mode](#) instructions in this manual for details.

The Q-Stress system can function as a standalone workstation or can be set up in a distributed configuration where the database resides on a server supporting a number of networked client workstations.

The Q-Stress Review software offers users with appropriate permissions at a networked location the ability to schedule new exams when not linked to an external scheduling system, view full disclosure exams, enter conclusions, and generate printed or electronic reports for completed exams.

The Q-Stress workstation includes:

- PC with keyboard and mouse configured with cardiac stress application software
- 24" wide-screen color monitor
- Z200+ thermal array writer
- Q-Stress front end (AM12Q or WAM) for signal processing
- Trigger Module for analog/TTL signal output
- Isolation transformer
- System cart
- 10-lead ECG patient cable with or without replaceable lead wires
- Stress belt to support the patient cable
- Local area network (LAN) support

Optional items include:

- High-speed laser printer
- Treadmill
- Ergometer
- Programmable remote keypad
- Integrated non-invasive blood pressure monitoring with or without SpO₂

Miscellaneous System Information

- Q-Stress is capable of supporting the following video resolutions: 1920 x 1080 and 1920 x 1200.
- Q-Stress is capable of supporting HP LaserJet printers with 600 dpi and PCL5 capabilities, and Welch Allyn's Z200+ thermal printer.
- Connecting multiple devices using network cables creates a medical system. This system should be evaluated for compliance with IEC 60601-1, Clause 16 prior to use in the patient vicinity.

NOTE: *No user-serviceable parts are inside. Any modification to any part of device is to be performed by qualified service personnel only.*

About the Q-Stress

Q-Stress documents four phases of a patient's exercise test: pre-exercise (resting ECG), exercise, recovery, and final report (Report Manager). The initial observation phase allows the user to prepare the patient, choose the appropriate exercise protocol, and enable/disable various settings prior to exam start.

Q-Stress is based on a Microsoft® Windows® operating system and conforms to common elements to perform tasks. The device keyboard provides an easy means for entering patient ID information at the start of the test, as well as comments in the Final Report phase; test functions are controlled by mouse or by on-screen menu functions using the keyboard. Using the customizable screen formats, operational conditions can be customized to suit specific needs.

Full features include:

- Automatic ST segment analysis and trending on all 12 leads.
- Superimposition comparison of current and reference complexes on both a 4x QRS, and updated 12-lead median complexes.
- Context View during the exam allowing full disclosure review and addition of past ECG events.
- Automatic ventricular ectopic beat detection.
- Up to 100 different exercise protocols.
- Automatic 12-lead ECGs with prompts for manual or automated (optional) blood pressure acquisition.
- Multiple final report formats with custom report sequence capabilities and automated narrative summary.
- Networked export of XML, PDF, HL7, or DICOM® results.
- Networked receipt of XML, HL7, or DICOM orders.
- Archive directories with full disclosure exam data.
- User-defined ST measurement points.
- Analog and TTL output for interface with external devices.
- Programmable and fixed protocols, procedures, and final reports.
- Pre-test electrode impedance check.
- Demonstration mode.
- Automated NIBP and SpO2 readings (with optional device).
- Various text and graphical formats.
- Medications, notes, diagnoses, indications, and procedural comment entries.
- Rate of Perceived Exertion (RPE) entry during test.
- Source Consistency Filter (SCF).
- Beat Consistency Filter (BCF) on ECG printouts.
- METs, maximum predicted heart rate, and target heart rate formula selection.
- Various exercise controls with compatible treadmills, ergometers, and pharmacological studies.
- Ability to select final report segments including Patient Information, Exam Summary, Rate/BP/Workload Trends, ST Level Trends, ST Slope Trends, Worst Case Average, Periodic Averages, Peak Averages, and ECG Prints.
- ST level and slope data for lead and worst-case average beat, updated continually during test.

- Editing of final report in Review phase.
- Paperless workflow capability.
- Ability to store exams and final reports in a centralized database.
- Pre-registration and scheduling of patients.
- Health risk assessment based on Duke and Functional Aerobic Impairment (FAI) algorithms.

NOTE: Arrhythmia detection is provided for the convenience of automatic documentation. The device offers no diagnostic opinion but provides documentation during the exam for which the operator renders their own medical opinion. Documentation is presented and stored for verification by a physician.

Figure 1 Q-Stress System*

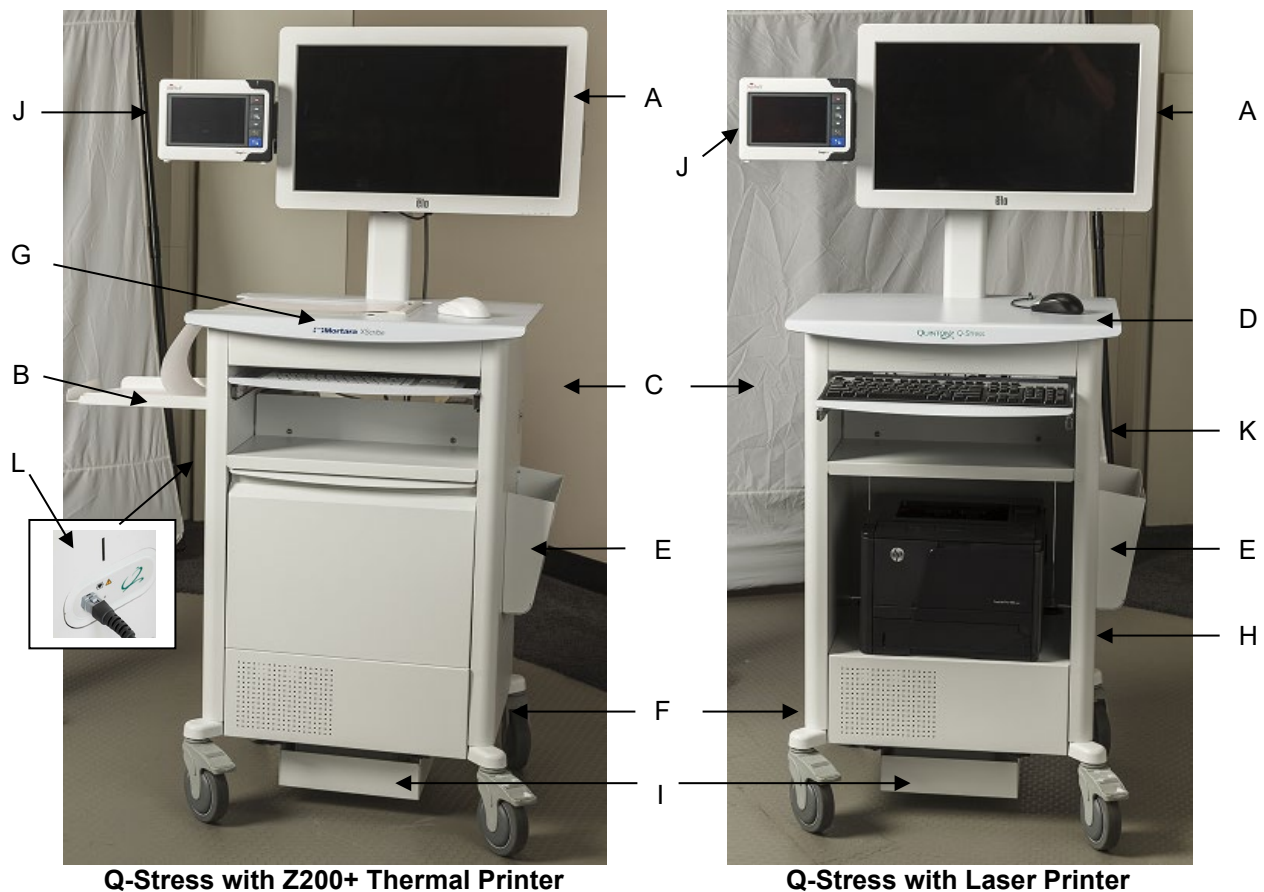

- | | | |
|---------------------------|--------------------------|--------------------------------|
| A. 24" Touch monitor | E. Storage bin | I. Isolation transformer shelf |
| B. Paper catch tray | F. CPU compartment | J. SunTech Tango M2 (optional) |
| C. Keyboard | G. Z200+ thermal printer | K. Trigger module |
| D. Laser printer desk top | H. Laser printer | L. Q-Stress front end |

*Subject to change without notice

Q-Stress ECG Acquisition Devices and Accessories

AM12Q Module Front

For Q-Stress patient cable connection



AM12Q Module Back

For USB connection to the Trigger Module



10 Lead Patient Cable for Q-Stress

43-inch or 25-inch lead wires with pinch ends connects to AM12Q



Stress Pouch and Belt for the 10 lead wire patient cable

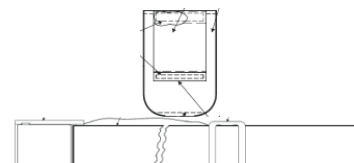

Trigger Module Front

ECG A connector for AM12Q connection and one analog signal connector (⊕ 1)



Trigger Module Back

Analog signal connector ⊕ 2, analog signal connector ⊕ 3, TTL (⊕ 1L) output connector, ECG B connector, and USB PC connector



WAM™ Wireless Acquisition Module and UTK Receiver

WAM for wireless ECG acquisition with the USB UTK module incorporates frequency-hopping technology in the 2500 MHz frequency range with 40,000 Hz ECG acquisition. Uses one AA alkaline battery that will power the device up to 8-hours of intermittent operation. Uses replaceable lead wires with medi-clip connectors.

UTK connected to the Q-Stress USB port receives ECG signals from the paired WAM for presentation of the electrocardiogram. A USB port built into the Q-Stress cart display mount top is most appropriate for this device. Alternatively, the UTK connected to USB cable (6400-012) from the PC port may be mounted in an unobstructed location.

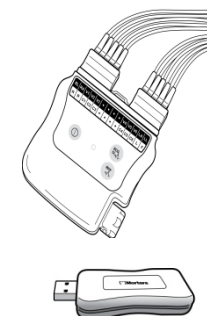

Stress Pouch and Belt for the WAM



Supported Treadmills

Quinton TM55, Quinton TM65, Trackmaster TMX425, and Trackmaster TMX428

Supported Ergometers

Ergoline, Lode Corival, and Medical Positioning

Supported Automatic Blood Pressure Devices

SunTech Tango+, SunTech Tango M2, Ergoline, and Lode Corival

Q-Stress Software Installation Process

NOTE: If installing or upgrading the software on a PC with out of date Microsoft certificates, internet connection is required to obtain updated Microsoft certificates.

Navigate to the location of the software to be installed and double click on the “Setup” application file. If asked to allow the program to make changes to the computer, click **Yes**.

The Exam setup window will appear prompting you to install Mortara PDF; click **Install**.

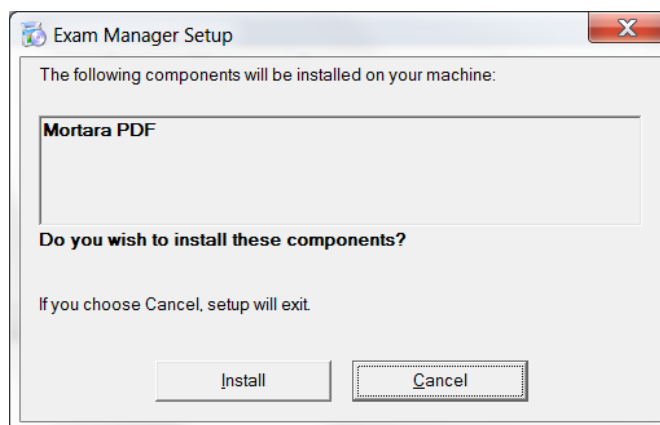

At the setup window, click **Next**.

NOTE: If you are upgrading the system from a previous version, the next step will be omitted.



There are four installation choices that simplify the installation process.

Standalone: Choose the standalone option if you are loading a single Q-Stress application with the Database Server functionality included on a single computer.

***NOTE:** You will also choose the Standalone option when loading cardiac stress application and Rscribe with the Database Server functionality onto a single computer.*

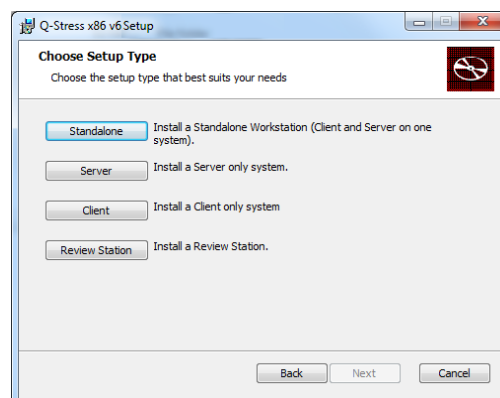

Server: This option allows for installations using multiple networked computers with the Database Server functionality loaded onto a separate computer or a Server hardware platform.

Client: Choose this option if you are loading the Q-Stress application on a computer that will be networked to the Database Server functionality on a different computer.

Review Station: Choose this option when loading the ability to review exams that are acquired on a networked computer, with the Database Server functionality already loaded onto a separate networked computer.

Choose the setup type as **Q-Stress** or **Q-Stress with RScripte**.

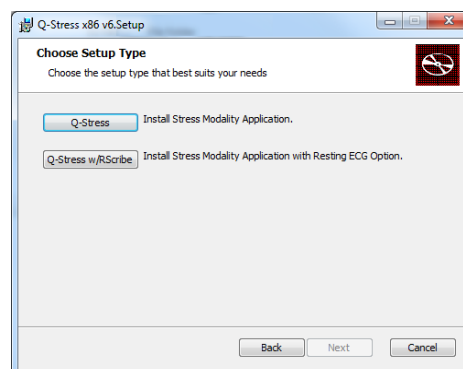

Once **Q-Stress** or **Q-Stress w/RScripte** is selected, the Server Configuration dialog is displayed.

DB Port: It is recommended that you use the default port number for the installation. If the port is already being used, the installation tool will alert you that the port is already taken and a new port number will need to be entered to continue with the installation.

Unique Patient ID: This option defaults to a YES (checked) condition to configure the system to utilize the Patient ID field as a unique identifier for patient demographic information, which is the most typically used system configuration.

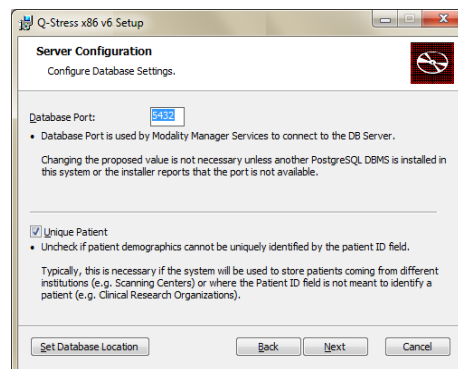

The Unique Patient option box can be UNCHECKED if the system is to be configured without using the Patient ID field as a unique identifier for patient demographics. This type of configuration is used when patients may be entered from different institutions that use different ID schemes; or instances where the Patient ID field is not used to identify a patient.

Set Database Location: Selection of this button allows you to **Browse** to a location for the Q-Stress application and database other than the local default (C:) directory, beneficial when it is necessary to define the application and database locations on a different data drive.

- This selection allows a preview of **Disk Usage** to ensure requirements are met.
- The **Reset** selection will return all changes to default settings.
- Select **Next** to return to the Server Configuration window to continue the installation steps.
- Select **Cancel** to exit the installation process.

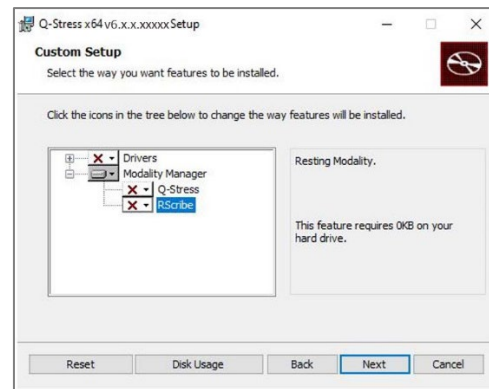

Once the selections are made, click **Next** and the Installation window will appear.

Click **Install** to continue.

The wizard will now load the software files to the defined location. Wait while this process runs.

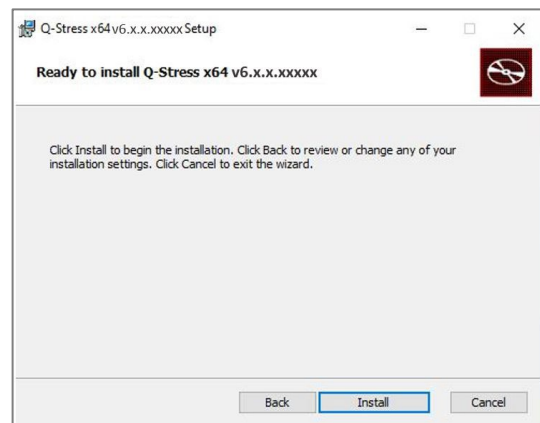

After the software installation is complete, you will be prompted to install device driver software.

Enable **Always trust software from Mortara Instrument, Inc.** and then select **Install**.

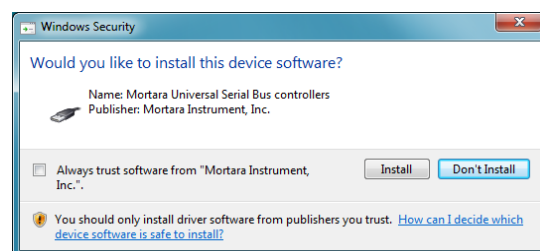

The Modality Manager Configuration window is presented.

NOTE: *If any changes are needed, the Modality Manager Configuration Utility can also be accessed after the installation process is completed by selecting the Modality Configuration settings from the Windows START menu → All Programs → Mortara Instrument.*

Refer to information below regarding configuration settings:

Language: This setting is always available to select the desired language.

Default height and weight units: Choose the desired units from the drop-down menus.

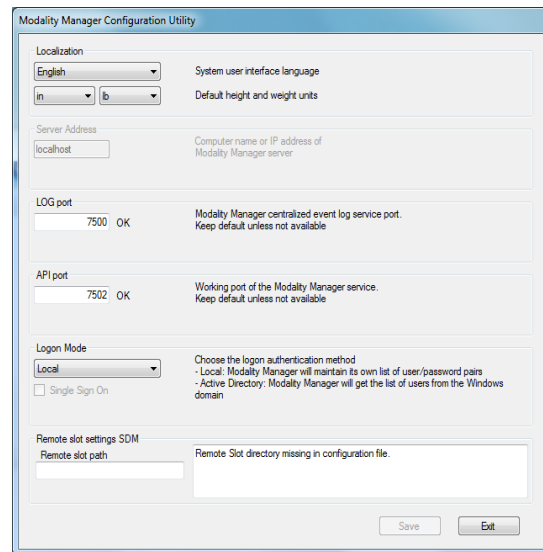

Server Address: This setting is grayed out when the Database Server functionality will be installed on the local PC, but will become an active selection when the modality will be accessing a remote Database Server.

Log Port: This setting is always available to select the port to be used for the event log service. Leave as default if the port is not occupied for other purposes.

API Port: This setting is always available to select the port to be used for Modality Manager Service.

Note: If ports are changed, ensure ports are enabled in firewall.

Remote slot settings SDM (Single Directory Management): This setting is only intended for distributed system configurations. Normally, when an exam is active (selected), all data will be copied from the system database to the local client workstation. If a path is entered here, the temporary data will be copied to a central (local) folder on the server. This method is not typically used but may be desirable for users that will review only.

Logon Mode: This setting is available on the server (not the client) and can be set to either Local or Active Directory depending on the user preference.

- If Local is selected, the Modality Manager Service will maintain its own local listing of users and passwords for logging onto the system.
- If Active Directory is selected, the Modality Manager service will maintain a listing of authorized users, while user logins will be performed against the Windows domain..

Note: Single Sign On is grayed out except when Active Directory logon is enabled.

Once the settings are correct, select **Save** (if you changed anything), then select **Exit** to continue.

If you exit without saving modified settings, a warning message will appear.

Click **Finish** to complete the installation process.



Feature Activation

An activation code is required to permanently operate full Q-Stress software functions such as start an exam, access stored exams, schedule patients, review exams, store exams, archive exams, export results and other tasks. Without activation, the system will function for a period of fourteen days and will then become invalid.

To prepare for activation, run the Modality Manager Activation Tool accessed from the following menus:

- Start menu
- All Programs
- Mortara Instrument
- Modality Manager Activation Tool (click **Yes** when prompted to allow changes to the computer)

Once your system serial number is entered, this utility generates the site code that is needed for activation by Welch Allyn Technical Support personnel. You can click on the **Copy to Desktop** or the **Copy to Clipboard** button to generate a information to be e-mailed tom.com.

Welch Allyn Technical Support will return an activation code that can be typed or copied and pasted into the white space above the "Activate License" button. Select the Activate License button to activate the software. You can activate the software at any time after installation with the Modality Manager Activation Tool. Contact Welch Allyn Technical Support personnel for further information.

Starting the Q-Stress Workstation

The ON/OFF switch is located on the front side of the CPU. When the switch is depressed, the workstation will power on. To turn on the LCD screen, locate the display main switch.



CAUTION: Do not run any other applications, including screen savers, when performing a stress test. Once the test has begun, the Q-Stress application does not allow the user to access other system functions.

Q-Stress Login and Main Display

The Q-Stress application requires user credentials on startup when not set up for SSO, when the current Windows user account is not provisioned in Q-Stress, or when SSO is setup but not currently available. The default factory Username and Password is admin. The password is case sensitive.

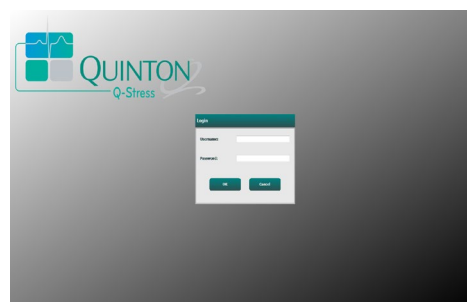

Upon successful login, the application will present a screen similar to the one shown at the right. The user name and software version is shown in the bottom left corner. Click on any of the icons representing workflow to perform a specific task.

The Q-Stress Username and Password are entered then the **OK** button is selected to open the application main menu. Some of the icons may be grayed or absent depending on the user permissions and system configuration.



Hovering over an icon will display a textual message showing its function. Icons that are not permitted for the logged in user are grayed and unavailable.



The first time you login, you will need to select the **System Configuration** icon to setup your access to all functions.

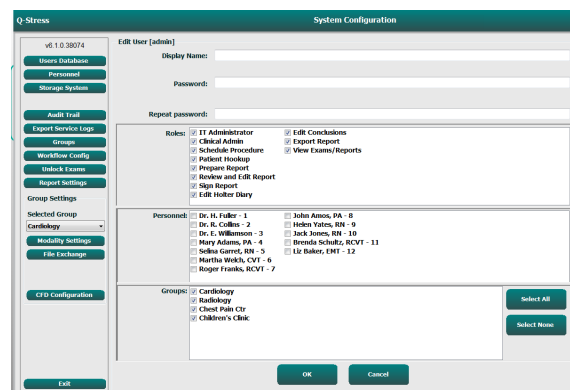

1. Select the **User's Database** button and you will see the "IT Admin" user. Double-click on the name to open the role privileges and check desired functions.
2. Click **OK** → **Exit** → **Exit** and start up Q-Stress again. If you don't do this, most all icons are grayed and unavailable.



Q-Stress Icon Descriptions

Icon and Hover Text	Description
 <p>Q-Stress</p>	<p>Q-Stress desktop shortcut icon to launch the Stress modality application.</p>
 <p>Schedule/Orders</p>	<p>Opens a window with two selectable tabs. A MWL (Modality Work List) tab allows exam scheduling (when no orders interface exists) and schedule review. A Patients tab allows addition of new patient information and editing of existing patient information.</p>
 <p>Start a Stress Test</p>	<p>Opens a window presenting scheduled exams under the MWL tab and patient demographics under the Patients tab.</p> <p>The observation screen with the stress hookup display is opened when the Start Exam button is selected.</p>
 <p>Exam Search</p>	<p>Opens a window allowing users to search for Stress exams or patients in the database using filters.</p>
 <p>User Preferences</p>	<p>Opens a window for configuring the user preferences for the Worklist, List Customization, and changing the password.</p>
 <p>System Configuration</p>	<p>Opens a window for administrative users to configure the system settings such as creating/modifying users, changing the Q-Stress default settings and protocols, defining archive directories, and so on.</p>
 <p>Exit</p>	<p>Closes the Q-Stress application and returns the user to the desktop.</p>
	<p>Allows users to Minimize or Exit the application and return to the desktop.</p>

User Roles and Permissions

Q-Stress supports a workflow oriented setup for defining user roles and controlling user access to the various operations. Role assignments are comprised of a set of permissions for each user type (e.g., IT administrator, clinical administrator, Stress Hookup Tech, and so on).

Each user can be assigned a single role or a combination of roles. Some roles include permissions assigned to other roles where applicable. After installation, a single user is created, with the role of "IT Administrator". Before using Q-Stress, this user must log in and create other required clinical users and roles.

Roles	Permission Assignment
IT Administrator	Manage user permissions; manage personnel lists; export settings; archive settings; workflow configuration; storage system configuration; unlock exams; view audit trail reports; export service logs; create and modify groups.
Clinical Administrator	Manage database exams (delete, archive, and restore); copy exams offline to share with Welch Allyn personnel or other sites; view audit trail reports; modify modality settings (profiles, protocols, and other stress specific settings); reconcile; export service logs.
Schedule Procedure	Create new patient orders; associate an order with an existing patient; modify demographics of an existing patient; export service logs. <i>Scheduling and order entry is only available when Q-Stress is not linked to an external scheduling system.</i>
Patient Hookup (Start Stress Exam)	Ability to start a stress test using Start a Stress Test icon. Includes the ability to create a new patient; associate an order with an existing patient; export service logs.
Edit Holter Diary	Not applicable to the Q-Stress application.
View Exams/Reports	Review exams and final reports only. Includes the ability to search exams, view and print reports; export service logs.
Prepare Report	Review and edit exams to move them from an acquired state to the edited state. Includes ability to search exams and view and print reports; export service logs.
Review and Edit Report	Review and edit exams to move them to the reviewed state. Includes ability to search exams and view and print reports; modify and create conclusions; export service logs.
Edit Conclusions	Create and modify conclusions. Includes ability to review exams and final reports only; search exams and view and print reports; export service logs.
Sign Report	Ability to move exams to a signed state. Includes ability to review exams and final reports; search exams and view and print reports; export service logs. Requires user authentication.
Export Report	Ability to export a PDF and XML file when features are enabled. Must be assigned in conjunction with another role (e.g. Review, View, or Conclusions).

Refer to [User Role](#) assignment details.

Q-Stress Network Operation in a Distributed Configuration

The Q-Stress network capabilities leverage a common database across multiple networked Q-Stress workstations where exams will be conducted and Q-Stress Review stations where acquired exams can be reviewed and edited.

A distributed configuration is comprised of a dedicated server and a number of networked client Q-Stress workstations and Q-Stress Review Stations sharing the same database.

A distributed configuration supports efficient operation for a busy cardiac stress department to:

- Create logins for all users at a single location who can log into any networked station.
- Define protocols, procedures, and system settings at a single location for all networked workstations and review stations.
- Manually schedule exam orders, when no orders interface exists, that are available to all cardiac stress workstations regardless of the lab location.
- Access and update Patient Information, cardiac stress exam data, and final reports from multiple locations.
- Start cardiac stress exams utilizing scheduled orders received from the institution information system with a single DICOM or HL7 interface to the shared database. Refer to [Q-Stress Data Exchange Configuration](#) for network interface configuration instructions.
- Selectively search the database to review any completed exam's full disclosure data. This includes the ability to edit, sign, print, and export the final report from multiple Q-Stress workstations and review stations on your network, dependent on the user permissions.
- Manage the stored data for all exams with ability to view audit trails, create groups, configure workflow, troubleshoot issues, and archive/restore/delete exams at a single location according to user permissions.

Microsoft Updates

Welch Allyn recommends that all Q-Stress workstations and review stations be periodically updated with Microsoft critical and security updates to protect from malware attacks and to fix critical Microsoft software issues. The following guidelines apply for Microsoft updates:

- Customer is responsible for applying Microsoft updates.
- Configure Microsoft updates to be manually applied.
 - Turn automatic Windows update off and run it periodically as a manual action.
- Do not install Microsoft updates during active use of the product.
- Run a functional test after any update which includes conducting a test exam as well as importing an order and exporting results (if activated) before running patient exams.

Each Q-Stress product release is tested against the cumulative Microsoft updates at the time of product release. There are no known Microsoft update conflicts with the Q-Stress application. Please contact Welch Allyn Technical support if conflicts are identified.

Anti-Virus Software

Welch Allyn recommends the use of anti-virus (AV) software on computers hosting the Q-Stress application. The following guidelines apply in the use of AV software:

- Customer is responsible for installation and maintenance of AV software.
- AV software updates (software and definition files) should not be applied during active use of the Q-Stress application.
 - AV patch updates and system scans should be scheduled for time periods when the system is not actively in use or should be performed manually.
- AV software must be configured to exclude files/folders as defined in [Cautions](#) in User Safety Information and below:
 - Welch Allyn recommends excluding the Q-Stress database folder (normally *C:\ProgramData\MiPgSqlData*) from the folders to be scanned.
 - Welch Allyn recommends excluding the Q-Stress main application folder (normally *C:\Program Files (x86)\Mortara Instrument Inc\ModalityMgr*) from folders to be scanned.

If a technical support issue is reported, you may be asked to remove the virus scanning software to allow investigation of the issue.

Encrypt Protected Health Information (PHI) Stored in Q-Stress

The Q-Stress database may be configured for Windows Encrypted File System (EFS) for protection of patient data security. EFS encrypts individual files with a key stored with the Windows user account. Only the Windows user that encrypts or creates new files in an EFS-enabled folder can decrypt the files. Additional users can be granted access to individual files by the original account that encrypted the files.

NOTE: *The Q-Stress system database must be unencrypted prior to performance of any software upgrades.*

Contact Welch Allyn technical support if your facility requires this security feature.

Operation without Server Connection

When the server is unavailable in a distributed configuration, the client workstation will notify the user with a prompt to proceed in Offline Mode or to cancel. In Offline Mode, scheduled orders are not available. An exam can be conducted with manually entered demographics and will be stored locally. When the server becomes available, the user is prompted with a list of unsent exams and a selection to send exams to the server database.

Protected Health Information (PHI) Data Confidentiality

AES encryption and WPA2 authentication are to be implemented when connecting to external EMR systems.

Patient details are to be deleted from the Q-Stress prior to system disposal.

Patient demographics are to be displayed from password protected screens.

Q-Stress Specifications

Feature	Workstation Minimum Specification*
Processor	Intel Core i3 4330
Graphics	1920 x 1080 or 1920 x 1200
RAM	4 – 8 GB
Operating System	Microsoft Windows 10 Pro 64-bit
Hard Drive Capacity	500 GB
Archive	Network or external USB drive
Input Devices	Standard keyboard and scroll mouse
Software Installation	Built-in or external DVD-ROM drive
Network	100 Mbps connection or better
Front-end ECG Devices	AM12Q with Patient Cable connector Wireless Acquisition Module (WAM) Trigger Module for analog and TTL signal output to external devices
Printing Devices	HP M501dn LaserJet printer (recommended) Z200+ thermal printer (requires USB port)
USB Ports	2 free USB 2.0 ports
Serial Ports	2 serial ports (dependent on use of serial interfaced equipment).
Audio	Required for NIPB and Pharmacological notification
Isolation Transformer - Required When Workstation is Used for Stress Testing	
Isolation Transformer Requirement	Known Agency Mark (KAM) Meets IEC 60601-1 requirements Protective Earth conductor for all connected equipment Z200+ only configuration: 300 watts LaserJet printer configuration: 1,000 watts
Feature	Server Minimum Specification*
Processor	Performance equivalent to an Intel Xeon class, Quad-core with hyperthreading
Graphics	1024 x 768
RAM	4 GB (8 GB recommended)
Operating System	Microsoft Windows Server 2012 R2 Microsoft Windows Server 2016 Microsoft Windows Server 2019 Microsoft Windows Server 2022
System Disk	100 GB for OS and product installation (RAID recommended for data redundancy)
Data Disks	550 GB hard drive space available HD controller with 128 MB read/write cache (RAID recommended for data redundancy)
Archive	Network or external USB drive
Software Installation	Built-in or external DVD-ROM drive
Network	100 Mbps connection or better
Input Devices	Standard keyboard and mouse
Input Power	100-240 V , 50-60 Hz

* Specifications subject to change - without notice.

Q-Stress System Dimensions and Weight

Item	Specification*
Height	39.5" (100 cm) floor to desktop; 62.5" (159 cm) floor to installed monitor top
Width	24.6" (63 cm) desktop only; 32.6" (83 cm) with paper tray; 50" (127 cm) with work surface extension and paper tray
Depth	22.5" (57 cm)
Weight	Approximately 270 lbs. (122.5 kg) for premium cart installed with all hardware and accessories including the SunTech Tango BP monitor

WAM Specifications

NOTE: Radio specifications and certification information for the Wireless Acquisition Module (WAM) and USB Transceiver Key (UTK), can be found in the WAM user manual.

Feature	Specification*
Instrument Type	12-lead wireless acquisition module for cardiac stress testing
Input Channels	12-lead signal acquisition and transmission
ECG Leads Transmitted	I, II, III, aVR, aVL, aVF, V1, V2, V3, V4, V5, and V6
WAM Transmission Protocol	Bidirectional and frequency hopping; beacon and response method links a single acquisition module to a single cardiac stress system
Frequency Range	2403.38 MHz to 2479.45 MHz
Channel spacing	1MHz
RF output power	<10dBm
Antenna Type	PCB inverted F
Antenna Gain	-0.33dBi
Modulation	MSK
WAM and Receiver Distance	Approximately 10 feet (3 meters)
Lead Set	RA, LA, RL, LL, V1, V2, V3, V4, V5, and V6 (R, L, N, F, C1, C2, C3, C4, C5, and C6) with detachable lead wires
Sampling Rate	40,000 samples/second/channel acquisition; 1,000 samples/second/channel transmitted for analysis
Resolution	1.875 μ V reduced to 2.5 μ V for analysis
User Interface	Button operation: ON/OFF; 12-lead ECG and rhythm strip buttons are non-functional with cardiac stress testing
Defibrillator Protection	Complies with AAMI standards and IEC 60601-2-25

Feature	Specification*
Device Classification	Type CF, battery operated
Weight	6.7 oz. (190 g) with battery
Dimensions	4.45 x 4.25 x 1.1" (11.3 x 10.8 x 2.79 cm)
Battery	1 AA alkaline 1.5V battery

* Specifications subject to change without notice.

UTK Specifications

Feature	Specification
Frequency	2403.38 MHz to 2479.45 MHz
Channel spacing	1MHz
RF output power	<10dBm
Antenna Type	PCB inverted F
Antenna Gain	-4.12dBi
Modulation	MSK

* Specifications subject to change without notice.

AM12Q Specifications

Feature	Specification*
Instrument Type	12-lead built-in acquisition module for cardiac stress testing
Input Channels	12-lead signal acquisition from connected patient cable with USB interface output
ECG Leads Output	I, II, III, aVR, aVL, aVF, V1, V2, V3, V4, V5, and V6
Lead Impedance Measurement	Mode provided through Q-Stress system user interface
Patient Cable Connection	ECG input with 12-pin female connector for Q-Stress cable
Sampling Rate	40,000 samples/second/channel acquisition; 1,000 samples/second/channel transmitted for analysis
Resolution	1.875 μ V reduced to 2.5 μ V for analysis
Defibrillator Protection	Supports patient cables that comply with AAMI standards and IEC 60601-2-25
Device Classification	AM12Q + Patient Cable is Type CF, Defibrillator Proof
Weight	12 oz. (340 g)
Dimensions	7 x 5 x 3" (18 x 13 x 7.6 cm)
Power	Powered by USB connection to the Q-Stress

* Specifications subject to change without notice.

Parts and Accessories

For more information on parts/accessories or to place an order, contact Welch Allyn. See [Maintenance and Troubleshooting](#) for contact information.

Part Number	Description
9293-062-50	AM12Q (FRONT END) WITHOUT PATIENT CABLE
30012-019-56	WIRELESS ACQUISITION MODULE (WAM) w/o LEAD WIRES
30012-021-54	UTK MODULE (receiver for WAM)
9293-047-70	AHA MEDI-CLIP SHORT CABLE SET (for WAM)
9293-047-61	IEC MEDI-CLIP STANDARD CABLE SET (for WAM)
30012-024-51	TRIGGER MODULE ASSEMBLY
8485-026-50	CARRY CASE & BELT ASSEMBLY (for the WAM)
60-00184-01	CABLE PATIENT 10 LEAD ECG 43" PINCH AHA
60-00186-01	CABLE PATIENT 10 LEAD ECG 43" PINCH IEC
60-00180-01	CABLE PATIENT 10 LEAD ECG 25" PINCH AHA
60-00182-01	CABLE PATIENT 10 LEAD ECG 25" PINCH IEC
037224-001	BELT (used with 60-0018X-01 patient cables)
037225-001	POUCH (used with 60-0018X-01 patient cables)
9100-026-11	PAPER Z2XX US CUED ZFOLD 250 SHEET PACK
9100-026-12	PAPER Z2XX A4 CUED ZFOLD 250 SHEET PACK
9100-026-03	PAPER HDR SMART CUED ZFOLD PACK
108070	ECG MONITORING ELECTRODES CASE 300
9515-001-51	PHYS GUIDE ADULT PED V7 INTERP UM _s
34000-025-1004	Z200+ THERMAL WRITER Standard/A4
Refer to the service manual (9516-205-50) for part number.	CPU WINDOWS 10 64-BIT
9970-011-50	REMOTE KEYPAD
9911-023-11	Q-STRESS TRANSPORT CART BASE
775413	4TH ED CART XSCRIBE/Q-STRESS BASE
775414	BNC CABLE MALE TO MALE 12 INCH
9911-023-23	Q-STRESS TRANSPORT CART CUTOOUT DESKTOP W/TRAY (for Z200+ model)
9911-023-24	Q-STRESS TRANSPORT CART SOLID DESKTOP (for Windows Laser Printer model)
9911-023-32	SUNTECH TANGO+ and TANGO M2 MOUNTING BRACKET for 24" LCD
9911-023-33	SUNTECH TANGO+ and TANGO M2 MOUNTING BRACKET for ELO Touch Monitor

Support Parts

The following parts can only be ordered by Welch Allyn personnel.

Part Number	Item
Isolation Transformer and Power Cord	
1404-004	TRANSFORMER ISOLATION 1000VA MED GLOBAL
3181-008	POWER CORD US/CAN HOSPITAL 5-15P+320-C13
3181-002	POWER CORD INTN'L CEE7/7+IEC320-C13
3181-003	POWER CORD BRIDGE 2m IEC320-C13+C14
Interface Cables and Adapters	
6400-015	CABLE EXTENSION USB TYPE A-TO-A 6 FT
6400-012	CABLE USB TYPE A-TO-B FULL SPD
7500-010	CLIP NYLON ADJUSTABLE ADHESIVE BASE CLAMP DIA 0.469 to 0.562 IN
7500-008	CLIP WIRE CORD 1x1x.53ID WHITE W/ADHESIV
25004-003-52	CABLE TRACKMASTER TO CPU Q-STRESS
9912-018	CABLE ERGOMETER INTERFACE ERGOLINE
9912-019	CABLE ERGOMETER INTERFACE LODE CORRIVAL
6400-001	CABLE PWR DC F SR CONN STRPD 10"
8342-007-01	SPACER A4 PAPER ELI 200+
Network and Miscellaneous Items	
9960-051*	NETWORK CARD PCI 10/100 FAST ETHERNET
9960-052	ISOLATOR ETHERNET LOW LEAKAGE RJ45/RJ45
6400-010	CABLE ETHERNET CAT5e RJ-45 M SHLD 2FT
6400-008	CABLE ETHERNET RJ-45M TO RJ-45M STR-THRU
6400-018	CABLE LONG CROSSOVER CAT5e RJ-45 M SHLD 6FT

*Used for legacy Z200+ printer models.

8. MWL/PATIENTS

The MWL/Patients icon allows you to schedule stress exams and enter patient demographic information.

When the modality is linked to an external scheduling system, this information arrives from institution entered orders.

When the icon is selected, a split window appears with two selectable tabs (MWL and Patients) on the left and Patient or Order Information fields on the right, dependent on the selected tab.

A Search field and button are present below the tab selections.

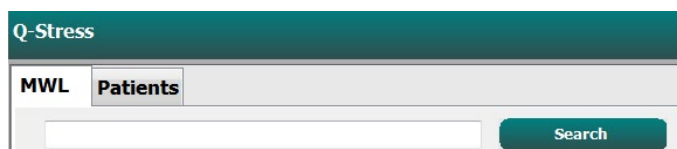

MWL

Text that is entered in the search field will be used to search through the Modality Worklist (MWL) to display orders that start with matching text in the Last Name, First Name, or Patient ID. A blank search field will list all orders.

MWL columns include Scheduled Date/Time, Patient ID, Last Name, First Name, Date of Birth, and Group. The list can be sorted by selecting the column headers. A second selection on the same header will reverse the column order.

Edit Order

Selection of an entry in the list will display the Order Information as read-only. Select the **Edit** buttons to modify the order. Select the **Save Order** button to save changes or **Cancel** to cancel all changes.

***NOTE:** This function is not available when the DICOM feature is enabled.*

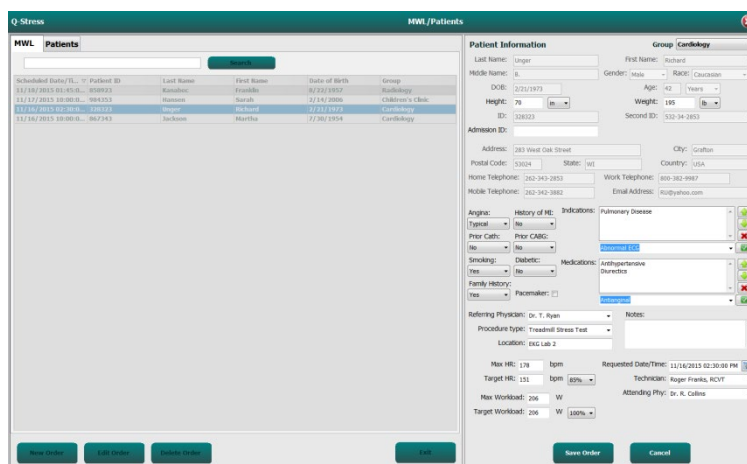

New Order

A **New Order** button allows a Patient ID or name search of patient information in the database allowing addition of a new order in the MWL list. A blank search field will list all patients in the database.

The screenshot shows the MWL/Patients interface. On the left, there is a table of patients with columns for Scheduled Date/Time, Patient ID, Last Name, First Name, Date of Birth, and Group. Below the table is a search field and a 'Search' button. On the right, there is a 'Patient Information' form with fields for Last Name, First Name, DOB, Height, Weight, and Second ID. There are also dropdown menus for Gender, Age, and Group. At the bottom, there are buttons for 'New Order', 'Cancel', and 'Save'.

When the patient does not already exist in the database, **Cancel** the Patient Information search and select the **Patients** tab to enter a new patient. Instructions are on the following page.

The patient information populates the Order Information at the right of the display. Additional order information can be entered and the order saved. The **Cancel** button will close the order without saving.

When entering an order, use the **Group** drop-down list to assign the order to a specific group that has been configured in the system settings.

Select the calendar icon in the bottom right corner of the **Order Information** section to open a calendar for selection of the scheduled order date and time. Date and time may also be entered by typing in the **Requested Date/Time** field.

The screenshot shows a calendar for April 2015. The date 04/30/2015 14:35:37 is displayed at the top. The calendar grid shows the days of the week and the dates. The time 14:00:00 is selected in a time picker. There are 'OK' and 'Cancel' buttons at the bottom.

Delete an Existing Order

Select an existing patient order by highlighting the line and then select **Delete Order**.

A warning message prompting delete confirmation will appear. Select **Yes** to delete the order or **No** to cancel and return to the MWL listing.

Exit MWL/Patients

Select the **Exit** button when finished to return to the main menu.

The screenshot shows a warning dialog box with a yellow warning icon and a red 'X' icon. The text reads: 'Warning: Do you really want to delete the selected Order?'. There are 'Yes' and 'No' buttons at the bottom.

Patients

Text that is entered in the search field will be used to search through the patient demographics in the database to display any patients that start with matching text in the Last Name, First Name, or Patient ID.

Patients' columns include Patient ID, Last Name, First Name, and Date of Birth. The list can be sorted by selecting the column headers. A second selection on the same header will reverse the column order.

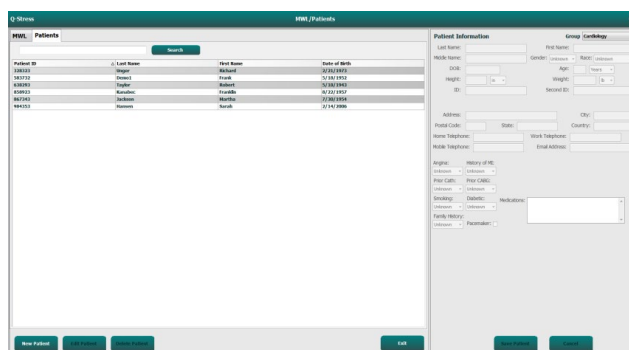

Edit Patient

Selection of an entry in the list will display the Patient Information as read-only. Select the **Edit** button to enable and modify the patient demographics fields.

Select the **Save Patient** button when finished to save changes or the **Cancel** button to return to read-only demographics without saving changes.

New Patient

A **New Patient** button clears any selected patient information allowing addition of a new patient in the list. The new patient information can be entered in the demographic fields and the **Save Patient** button selected to save it to the database. The **Cancel** button will close the patient information without saving.

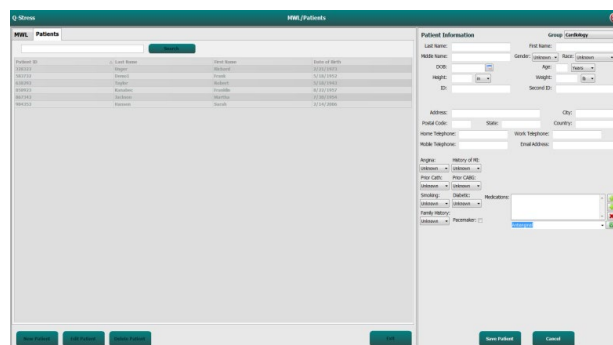

Delete Patient

Select the **Delete** button to remove patient demographics from the database.

NOTE: The Delete button is disabled when the patient demographics are associated with an existing order or exam. All orders and exams for that patient must first be deleted before the patient demographics can be deleted.

A warning message prompting delete confirmation will appear. Select **Yes** to delete the patient demographics or **No** to cancel and return to the Patients listing.

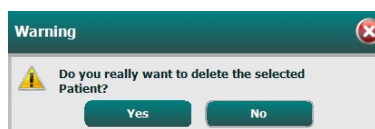

Exit MWL/Patients

Select the **Exit** button when finished to return to the main menu.

9. SETUP AND INSTALLATION

Q-Stress System Setup and Component Installation

NOTE: Refer to [Interconnect diagram, Figure 2](#).

NOTE: Setup and installation are performed by a Hillrom representative.

1. Assemble the Q-Stress system cart and connect all system components according to the Q-Stress System Installation Manual, part number 9515-205-60-ENG, included with the shipped items. Make sure all cables are seated completely onto their respective connectors and that all methods of securing cables to connectors are properly used.
2. Connect all power cords on the CPU and the printer to the isolation transformer; leave the power switches of these components in the ON position. Connect the isolation transformer to an approved hospital-grade AC power outlet and turn the isolation transformer to the ON position.

NOTE: After initial equipment installation is complete, the power switch on the isolation transformer will power up the Q-Stress system. The isolation transformer also supplies power to the Z200+ thermal writer which does not have its own ON/OFF switch.

NOTE: When finished using the Q-Stress system, a Windows system shutdown should be performed. This will power off the CPU and put the display in standby mode. The isolation transformer will remain powered on.

3. Refer to [Introduction](#) for Q-Stress software installation and activation.
4. Refer to [TTL/Analog Output](#) for TTL and analog output setup and installation.
5. Refer to [Treadmill/Ergometer Hookup](#) for Q-Stress to treadmill or Q-Stress to ergometer hookup instructions.
6. Refer to [Configure Printer](#) for configuring and using the Z200+ thermal printer.
7. Refer to [SunTech Tango+ and Tango M2 Interface](#) for SunTech Tango+ and Tango M2 BP monitor interface.
8. Start the Q-Stress system by turning on the CPU power button. When the Windows screen appears, log onto the system.

Figure 2 Q-Stress Interconnect Diagram

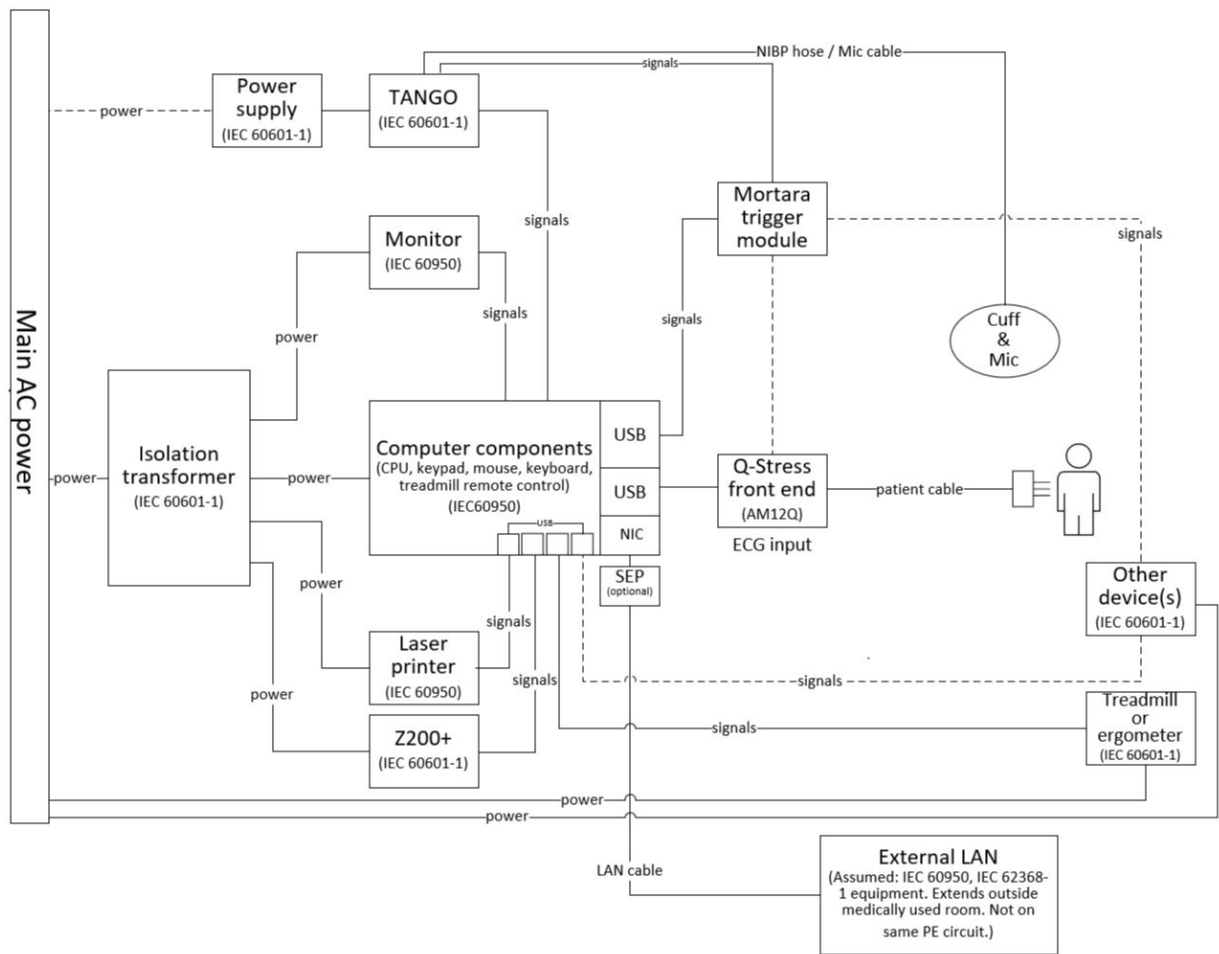

WARNING: To prevent electrical shock to the patient, the computer monitor, and printer must receive power from the Certified Separating Device (Isolation Transformer).

NOTE: The Certified Separating Device (Isolation Transformer) will power up to four devices. When more than four devices require power, the Tango BP Monitor must be powered by another available AC power outlet. The SunTech Tango unit does not require connection to the isolation transformer, as it is a medical device that includes its own isolated power supply. The Tango may be powered by the isolation transformer as a convenience.

Medical Isolation Transformer

The isolation transformer is a separating device that prevents system components from developing excessive leakage current. It is plugged into a dedicated circuit.

Figure 3 Medical Isolation Transformer

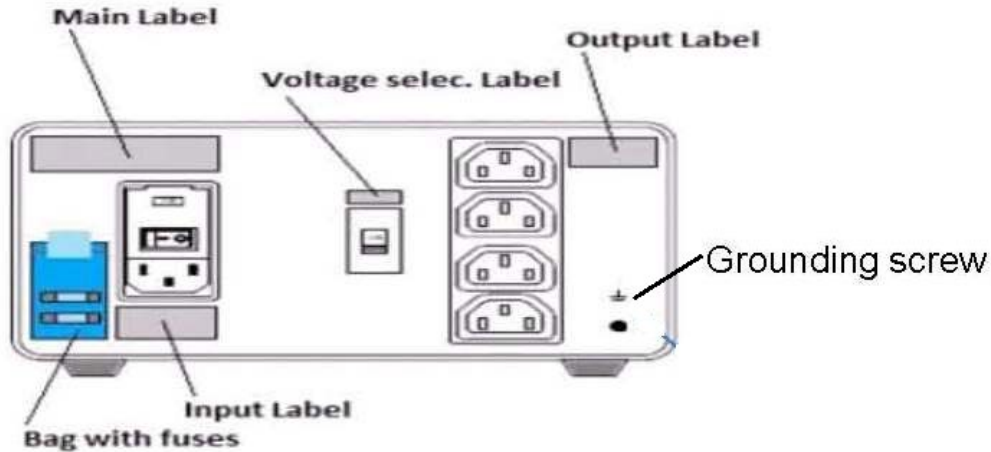



Medical Isolation Transformer Specifications

Frequency:	50/60 Hz
Output Ratings:	115/230V 1000VA
Weight:	22 lbs. (9.98 kg)
Dimensions:	Height = 5.1" (130 mm)
	Width = 8.0" (203 mm)
	Depth = 11.0" (280 mm)

REF: 1404-004 TRANSFORMER ISOLATION 1000VA MED GLOBAL
 Input 115VAC 50/60 Hz 2x10AT Fused / Input 230VAC 50/60 Hz 2x6.3AT Fused

 **CAUTION:** Before connecting system components to the isolation transformer, ensure the voltage selector (located above the power switch) is set to the proper line voltage. All units shipped from Welch Allyn are set to 115V. To change voltage to 230V, move the voltage selector switch located to the right of the power switch.

 **CAUTION:** Risk of electrical shock. Do not remove cover. Refer servicing to qualified service personnel. Grounding reliability can only be achieved when system components are connected to an equivalent receptacle marked "hospital grade."

 **CAUTION:** Use of this transformer with equipment other than originally supplied, or surpassing the ratings, may cause damage, fire, or injury.

 **WARNING:** Possible explosion hazard. Do not use in the presence of flammable anesthetics.

Q-Stress Front End and Patient Cable Connection

The Q-Stress 10-lead patient cable is connected to the Q-Stress Front End that digitizes and filters the patient’s ECG signals. The Q-Stress Front End is typically installed flush on the right or left side of the stress cart, dependent on the position of the patient in proximity to the exercise equipment that will be utilized.



Q-Stress Front End and Trigger Module Connection

The Trigger Module optionally provides analog and TTL signal output for connection to external devices such as an echocardiograph system. The Trigger Module is required when the SunTech Tango BP Monitor will be connected to the cardiac stress system.

Trigger Module Front



Q-Stress AM12Q Front End may be connected to ECG A USB connector on the module front. One analog output connection (⊕ 1) is also on the front.

Trigger Module Back



The module back provides two analog output connectors (⊕ 2 and ⊕ 3 are currently non-functional) and one TTL (⊕ TTL) output connection.

Q-Stress AM12Q Front End may be connected to the ECG B connector.

The UTK receiver must be connected to the ECG B connector when WAM is used with the Trigger Module.

The Trigger Module is typically installed flush on the right or left side of the stress cart, dependent on the position of the Q-Stress Front End location.

Refer to [TTL/Analog Output](#) for TTL and analog output setup. Refer to [SunTech Tango+ and Tango M2 Interface](#) for SunTech Tango+ and Tango M2 BP monitor interface.



NOTE: If using Q-Stress cart (P/N 775412 or 775413), the trigger module must be connected to the BNC connector using BNC cable (P/N 775414) to provide additional grounding using the port identified below.

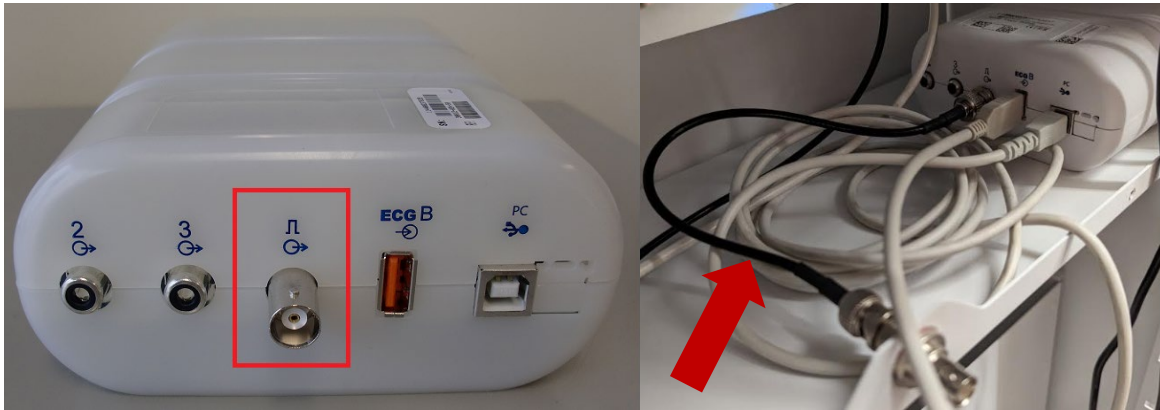

WAM Battery Installation

The WAM is powered with a single AA battery. When the battery contains sufficient voltage to operate and the patient is properly connected, an LED on the front of the WAM will appear solid green indicating proper pairing and communication with the electrocardiograph. A battery with low voltage or a lead fail will result in a flashing green or yellow LED.

To install a new battery, remove the battery cover by twisting the cover in a counterclockwise direction. Removal of the battery cover will automatically turn the power off. Insert one AA battery into the battery compartment aligning the battery’s positive (+) and negative (-) indicators with the designators shown on the device’s back label. Replace the battery cover by twisting the cover in a clockwise direction. The battery cover will seal the battery compartment and make contact with the battery providing power to the device.

Applying Power to the WAM

Before you apply power to the WAM, make sure that patient lead wires do not touch metal connected to ground (this may happen if reusable electrodes with exposed metal are used); the WAM will auto-calibrate at power-on, and a large amount of noise caused by ground loops may disrupt calibration, in which case the Q-Stress will not display ECG.

Press the power On/Off button to turn the device on or off. An audible tone will sound indicating power off and RF disconnect.

Attaching the WAM Lead Wire Connector Block

The 12-lead ECG lead wires consist of one connector block with 10 lead wires (5 leads wires to each side). The lead wires are positioned on the WAM to follow the contour of the torso. Each lead wire terminates in a medi-clip.

Securely insert the connector block into the ECG input connector on the top of the WAM.



CAUTION: Be careful to insert the connector block into the appropriate input connector by matching the lead wire labels to the WAM label.

Pairing the WAM with Q-Stress

Start the Q-Stress application. Start a stress test and navigate to the observation phase, then:

- Select **Local Settings** and choose **WAM** as the Front End.
- Select the **WAM Pairing** button.

- Select **OK**.
- Place the WAM (powered off) in close proximity to the UTK receiver connected to the Q-Stress USB port.
- Turn WAM on.
- A successfully paired message will display.
- Select **OK**.

NOTE: Ending the stress exam will automatically cause the WAM to power off. It is not necessary to pair the WAM with the same UTK to use it again.

NOTE: LED indication is not available when using WAM with Q-Stress.

NOTE: 12-Lead ECG and Rhythm Print buttons are non-functional when using WAM with Q-Stress.

WAM UTK Compatibility

A WAM with a “2” on its label will only be able to pair with a UTK that has a “2” on its label. Similarly, a WAM or UTK without a “2” will not be able to pair to a UTK or WAM that has a “2”. If there is trouble pairing the WAM, check the labels to ensure the WAM and UTK either both have a “2” or neither do.

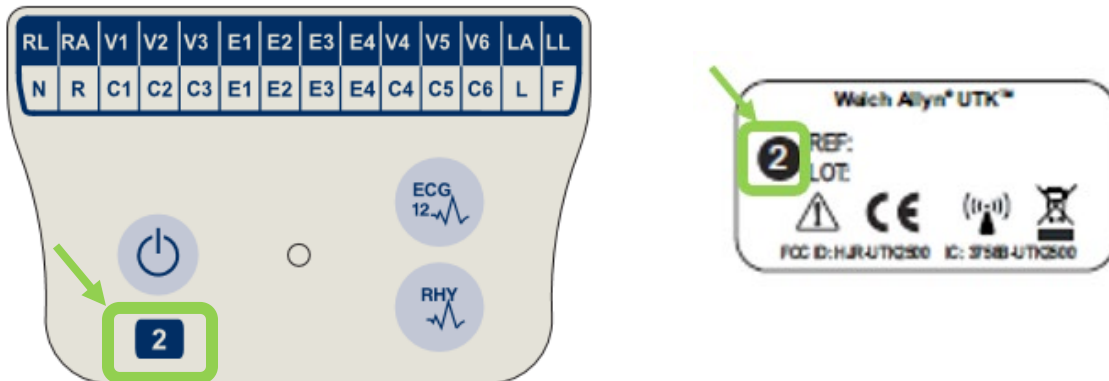

10. USING THE Q-STRESS

At the start of a stress exam, Q-Stress initially acquires a dominant QRS complex for each lead to build the first QRS template for the 12 ECG leads. The average QRS waveform for each of the 12 leads is updated after every beat. If the dominant QRS morphology changes, it is automatically detected and the new morphology is “learned” as the new dominant beat morphology. This event is labeled as DRC (Dominant Rhythm Change) on the displayed trends.

During the test, 12-lead ECGs can be printed automatically or manually. User-selected ECG format choices are: 6x2, 3x4, 3x4+1, 3x4+1 BCF, 3x4+3, 3x4+3 BCF, or 12x1 leads. These formats can optionally include an expanded average complex at 100 mm/s and 40 mm/mV (4x standard gain) with associated averaged beats on the printed ECG.

***NOTE:** Beat Consistency Filter (BCF) provides an averaged ECG printout utilizing the averaged ECG complexes. Printed lead labels designate ‘BCF’ next to the lead label (e.g. I BCF, II BCF, III BCF, etc.). The rhythm lead below the 12-lead ECG is real-time and does not reflect the BCF. Real-time ECG is always displayed on the screen during the exam.*

***NOTE:** The BCF introduces an additional two-second delay to the real-time ECG data.*

Depending on the parameters defined at setup, Q-Stress performs the following operations during the exam:

- Documents ventricular ectopy (isolated PVC, ventricular couplets and ventricular runs) as arrhythmias; and dominant rhythm change (DRC) stored in memory for later review, editing and inclusion in the final report.
- Workload changes at specified times with automatic progression by protocol definition.
- Highlights the BP menu and sounds audible prompts to signify upcoming measurements.
- Displays the expanded average complex of a user-defined lead or lead undergoing maximum ST segment change, and compares it to a reference complex for that same lead (Auto Compare).
- Displays trends of HR, ST Index, METs, BP, and Double Product (HR*BP).

Several rhythm display screens can be selected:

- **3-LEAD WITH ZOOMED ST ANALYSIS AND TRENDS**
Three channels consisting of 8 seconds of three user-defined leads
- **3-LEAD WITH ZOOMED ST ANALYSIS WITHOUT TRENDS**
Three channels consisting of 12 seconds of three user-defined leads
- **3-LEAD WITHOUT ZOOMED ST ANALYSIS AND WITHOUT TRENDS**
Three channels consisting of 15 seconds of three user-defined leads
- **3-LEAD WITHOUT ZOOMED ST ANALYSIS AND WITH TRENDS**
Three channels consisting of 12 seconds of three user-defined leads

- **6-LEAD WITH ZOOMED ST ANALYSIS AND TRENDS**
Six channels consisting of 8 seconds of six user-defined leads
- **6-LEAD WITH ZOOMED ST ANALYSIS WITHOUT TRENDS**
Six channels consisting of 12 seconds of six user-defined leads
- **6-LEAD WITHOUT ZOOMED ST ANALYSIS AND WITHOUT TRENDS**
Six channels consisting of 15 seconds of six user-defined leads
- **6-LEAD WITHOUT ZOOMED ST ANALYSIS AND WITH TRENDS**
Six channels consisting of 12 seconds of six user-defined leads

- **12-LEAD IN 6x2-FORMAT WITH ZOOMED ST ANALYSIS AND TRENDS**
Twelve channels consisting of 4 seconds of twelve leads

- **12-LEAD IN 6x2-FORMAT WITH ZOOMED ST ANALYSIS WITHOUT TRENDS**
Twelve channels consisting of 6 seconds of twelve leads
- **12-LEAD IN 6x2-FORMAT WITHOUT ZOOMED ST ANALYSIS AND WITHOUT TRENDS**
Twelve channels consisting of 8 seconds of twelve leads
- **12-LEAD IN 6x2-FORMAT WITHOUT ZOOMED ST ANALYSIS AND WITH TRENDS**
Twelve channels consisting of 6 seconds of twelve leads

- **12-LEAD IN 12x1 FORMAT WITH ZOOMED ST ANALYSIS AND TRENDS**
Twelve channels consisting of 8 seconds of twelve leads
- **12-LEAD IN 12x1 FORMAT WITH ZOOMED ST ANALYSIS WITHOUT TRENDS**
Twelve channels consisting of 12 seconds of twelve leads
- **12-LEAD IN 12x1 FORMAT WITHOUT ZOOMED ST ANALYSIS AND WITHOUT TRENDS**
Twelve channels consisting of 15 seconds of twelve leads
- **12-LEAD IN 12x1 FORMAT WITHOUT ZOOMED ST ANALYSIS AND WITH TRENDS**
Twelve channels consisting of 12 seconds of twelve leads

The Context View can be enabled to show a single lead from start of the pre-exercise phase through the recovery phase indicating automatic and manually stored ECGs. This view also allows addition of historic ECG events and deletion of ECG events that are not wanted.

Additional parameters displayed during testing may include the following:

- Treadmill speed and grade, or watts if an ergometer is being used
- Protocol name
- Stage hold (if selected)
- Heart rate (HR)/% of target HR, and target watts if ergometer is being used
- ST level in mm or μV and ST slope in mV
- BP and SpO₂ with time last acquired (optional)
- Stage and Stage Time
- Patient name
- Patient ID number
- Total exercise time
- METs and/or Double Product, and/or ST Index
- One average complex for each of the 12 leads superimposed for comparing current data to reference data
- User-defined, expanded average complex superimposed for comparing current data to reference data
- Running trends of METs with HR, BP systolic and diastolic values, and ST level

During the Recovery phase, Q-Stress will display both Patient Data and Conclusions selections that allow data entry for the final report. At the end of the Recovery phase, the Report Manager will display a summary page that allows definition and creation of the final report.

The final report may consist of the following sections that are user enabled or disabled:

- Patient Information
- Exam Summary
- Trends for Heart Rate, BP, workload, ST level, and ST slope
- Worst Case Average
- Periodic Averages
- Peak Averages
- ECG Prints
 - Automatic 12-lead ECGs per protocol
 - Peak exercise ECG
 - Arrhythmia events
 - User added 12-lead ECG Events (Supine, Standing, Symptoms, Perceived Exertion, etc.)

The patient information page printout can include the following information:

- Patient demographics
- Protocol
- Date and time of exercise start
- Target HR or target watts if ergometer was used
- Brief medical history
- Indications
- Medications
- Referring physician
- Procedure type
- Location
- Reason for end
- Symptoms
- Diagnosis
- Notes
- Conclusions
- Technician: [name]
- Attending Physician: [name]
- Reviewed by: [name]
- Signed by: [authorized signing physician name]
- Signed date

The exam summary page printout can include:

- Patient name, ID, date and time of exercise start, and protocol
- Summary of exercise time and leads with 100 μ V change, and total PVC count
- Risk scoring
 - Duke Score when a Bruce protocol is used
 - FAI% (Functional Aerobic Impairment percent) when a Bruce protocol is used
- Max values
- Max ST
- Max ST changes
- Stage or Minute summary

The stage summary printout includes tabular data consisting of the following data that may be included:

- Pre-exercise/exercise/recovery times
- Speed/grade or watts
- HR
- BP
- SpO2
- METs
- Double Product (Sys BP*HR)
- ST measurements of all 12 leads

In addition, the user can also print the following:

- One average complex by minute or by stage for each of the 12 leads in the Exercise and Recovery phases
- Trends of the ST level and slope, HR, BP, Double Product, workload and estimated metabolic equivalents
- Selected 12-lead ECGs
- Average beat reports for the worst case during exercise and recovery, or at peak exercise

Demonstration Mode

The Q-Stress includes a demonstration mode that provides a way to present features and train clinicians on system operation without the need for live patient connection.

The demonstration mode is enabled when a patient name of Demo and a number or multiple numbers is entered in the Last Name field (e.g. Demo1 or Demo2 or Demo123 and so on). The word “Demonstration” is watermarked within the ECG waveform to differentiate the display from live patient ECG waveform.

NOTE: The **D** must be upper-case and **emo** must be lower-case or the demonstration mode will not be enabled.

The user interface and display in the demonstration mode is no different than the user interface and display in the live mode, with a few exceptions:

- BP readings with a configured Tango BP monitor are not initiated. Demo BP values are periodically displayed and updated during an exam.
- Configured exercise equipment (treadmill or ergometer) is not controlled when in the demonstration mode.

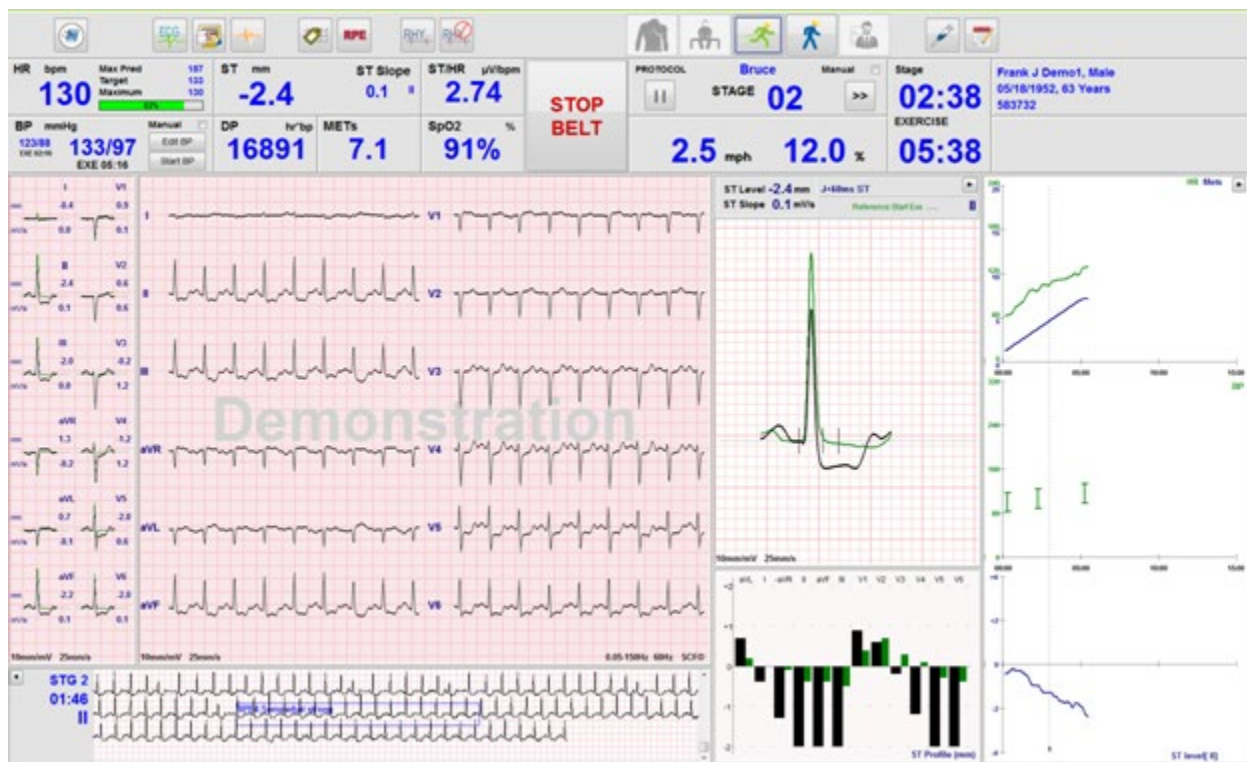

System Display During Exercise

The Q-Stress display is organized to provide the clinician quick access to important and critical information.

Feature	Description
Title Bar	Displays the Q-Stress program name and the current date/time.
Tool Bar	Contains buttons for actions dependent on the current phase. The user will touch, click or use shortcut function keys to access menus, print ECG, document events, and move through the cardiac stress testing phases.
Panels and Tiles	Patient and exam displayed information dependent on the current phase as well as the default modality settings and user-defined selections.

Bruce Treadmill Protocol with all Tiles and Panels



Bruce Protocol with Trends and Context View Panels Hidden

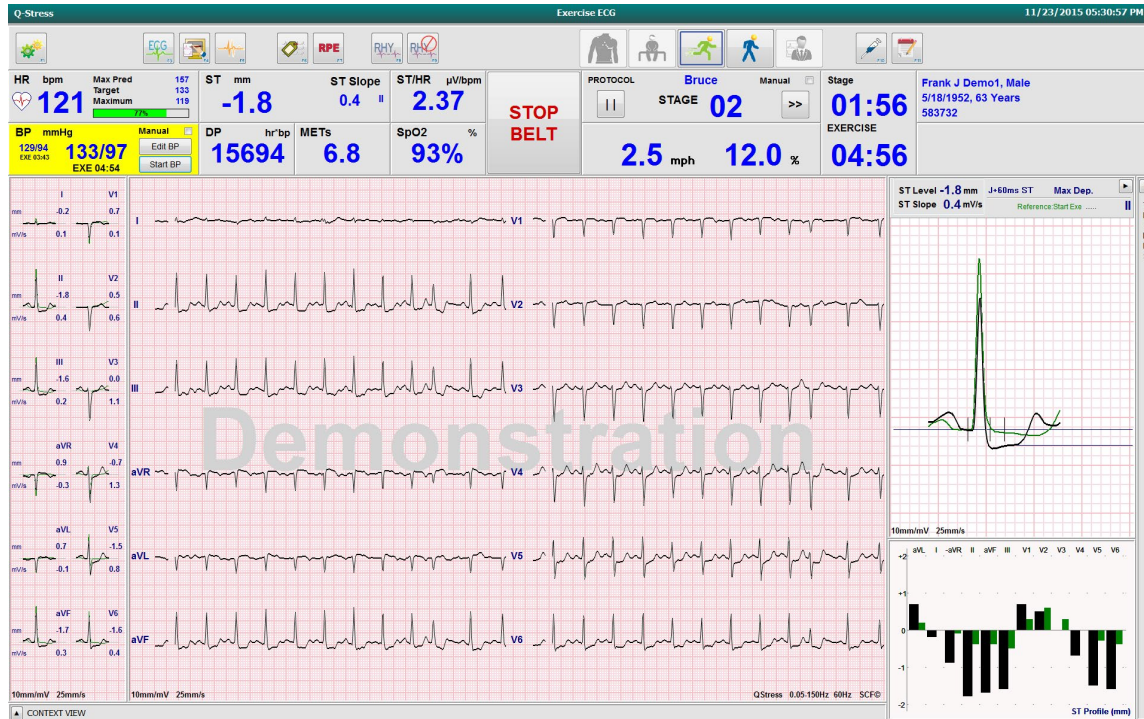

Bruce Protocol with Context View and Trends/Zoom ST/ST Profile Panels Hidden

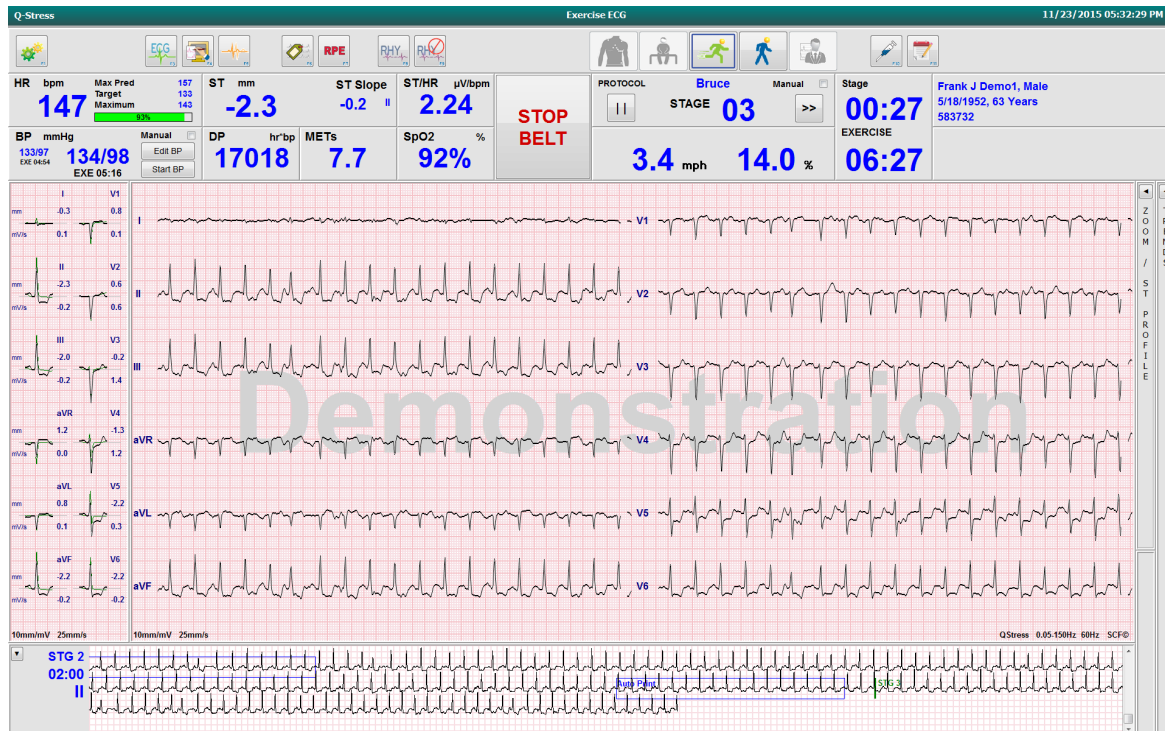

Bruce Protocol with Context View and Zoom ST/ST Profile Panels Hidden

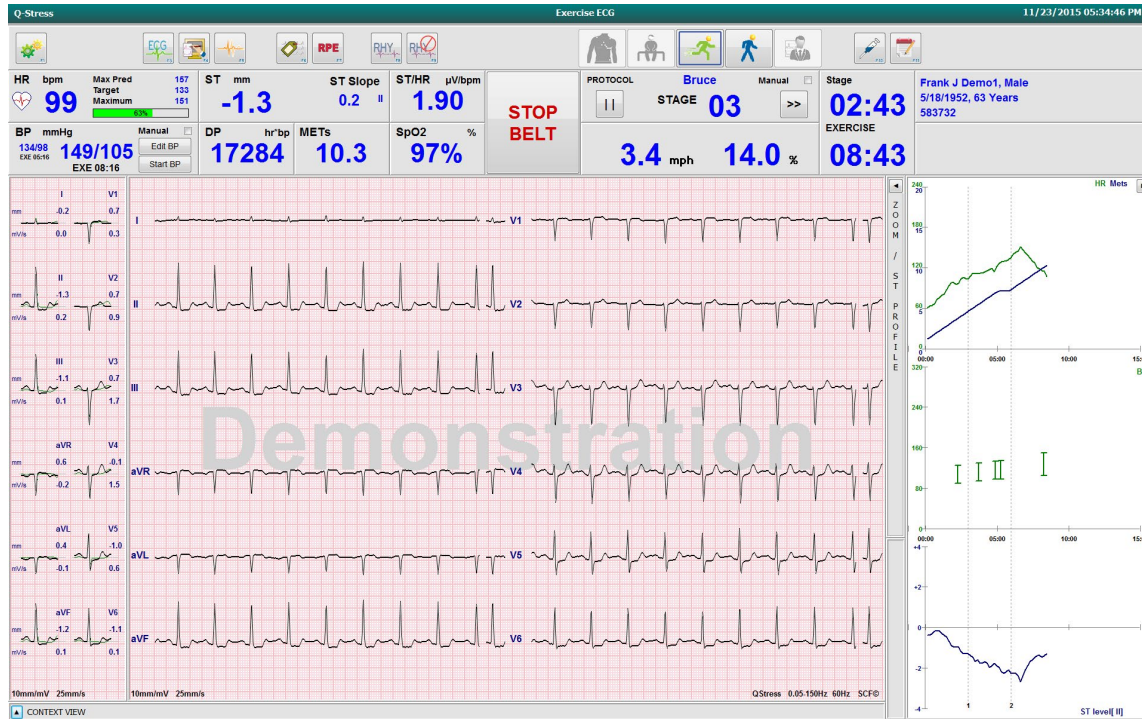

Cycle Time Ramp Protocol with Disabled SpO2%, Mets, DP, and ST/HR Tiles; Event on Profile









Tool Bar: Exam Phase Buttons

Once a stress exam is started, patient information is complete, and display settings are appropriate for the clinician, the exam is ready to begin. The Observation phase is entered allowing electrode impedance check and to confirm that the ECG signal quality is good.

Phase buttons are enabled as the exam progresses and serve as a guide to the clinician. The current phase is denoted by a dark blue border around the button. Available buttons are colored. Unavailable buttons are grayed.





As an example, the exam will begin in the Observation phase with only the Pre-exercise phase button available. Once Pre-exercise begins there is an important learning process that must occur before the Exercise phase can be entered. Once Exercise is started, Recovery is the only available button. In this way, the user cannot make a mistake by skipping Recovery and going to End Exam. The user is also prompted to confirm the end of the test before entering the Report Review phase.



Phase Button	Action and Description
<p>Observation</p>  	<p>The blue border shows that this is the current exam phase. 12-lead ECG is displayed in 6x2 format to observe ECG quality and re-prepare lead sites if necessary.</p> <p>Impedance Check allows the user to verify that leads are connected satisfactorily. Select this button to display impedance measurements that continually cycle for all leads.</p> <p>Each lead site indicates the ohm level and if electrode conduction is good (green), fair (yellow), poor (red), or the lead is not connected (white).</p>
<p>Pre-Exercise</p> 	<p>There is no blue border with this colored button example, indicating it is available for entry into the Pre-exercise phase. SCF (if enabled) and ST learning will begin immediately upon entry into the Pre-exercise phase.</p>
<p>Exercise</p> 	<p>Selection of this button will begin Exercise according to the selected protocol.</p>
<p>Recovery</p> 	<p>Selection of this button will end exercise and begin the Recovery phase.</p>
<p>End Exam</p> 	<p>The clinician is prompted upon selection of the End Exam button: Are you sure you want to exit the exam? When OK is selected, Recovery is ended and the Report Manager display, showing exam results, is presented.</p>
<p>Abort Exam</p> 	<p>An Abort button allows the current exam to be exited without saving. Abort is available during the observation and pre-exercise phases.</p>





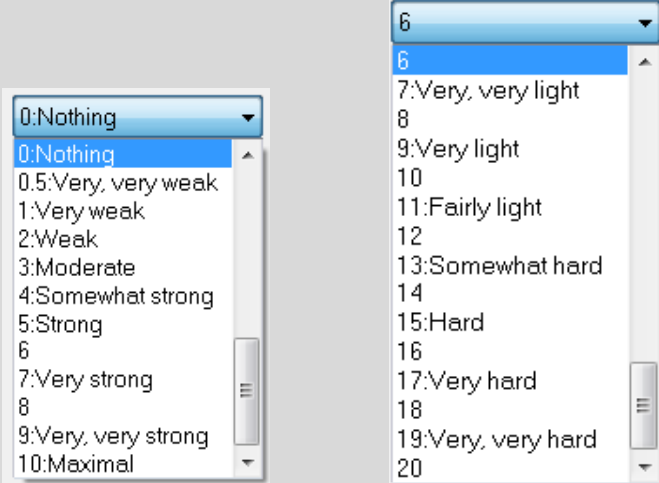

Tool Bar: Function Keys

Each toolbar button listed below is accessible via mouse, keyboard function key (F1 to F12), or by touch with an optional touch monitor; however, the mouse over a button to show its associated function key.

Left click the function key to activate a command or option. Some commands will open a pop-up window with drop-down menu options. At any time a pop-up window is open and an additional function needs to be selected, simply click on the next function, the open pop-up window will close, and the new function will be activated.







Function Key and Button	Action and Description
<p data-bbox="209 884 318 947">F1 Key Settings</p>  	<p data-bbox="453 669 1019 695">Displays the Local Settings window with two tabs.</p> <p data-bbox="453 743 1422 863">The Equipment tab allows selection of the front end type (Q-Stress) with Trigger Module Port, exercise equipment, BP equipment, AC frequency for this exam, and COM port settings. The Equipment tab is only available in the Observation phase. These settings are remembered for the next exam.</p> <p data-bbox="453 911 948 936">The Format tab allows the following settings:</p> <p data-bbox="453 953 1411 1010">When 3-Lead or 6-Lead format is selected for real-time display and printout, you can change combinations to any of the 12-leads using the drop-down menus for lead selection.</p> <p data-bbox="453 1047 1378 1104">Use the ECG Print Speed drop-down menu to choose the paper speed for the printed ECG. The default speed will be reset for each new test.</p> <p data-bbox="453 1142 1349 1199">Use the Continuous Print Speed drop-down menu to choose the paper speed for continuous rhythm printouts.</p> <p data-bbox="453 1236 1398 1293">Enable Arrhythmia Printouts to generate an automatic printout when an arrhythmia is detected. Arrhythmia events will continue to store when this selection is disabled.</p> <p data-bbox="453 1331 1419 1388">Use the Sync Lead drop-down menu to select the ECG lead to be used for TTL or analog output. The default lead will be reset for each new test.</p>
<p data-bbox="209 1419 302 1482">F3 Key ECG</p> 	<p data-bbox="453 1425 1390 1514">Selected to generate a 12-lead ECG printout during Observation, Pre-exercise, Exercise, Recovery, and Final Report phases. Printout configurations are based on definitions in modality settings.</p> <p data-bbox="453 1551 1427 1608">The patient's name, date, time, stage time, stage number, total exercise time, workload, lead labels, ST values, and calibration pulses.</p>
<p data-bbox="209 1640 375 1703">F4 Key Write Screen</p> 	<p data-bbox="453 1667 1414 1755">Selected to generate a 10-second page of the real-time ECG currently displayed at 25mm/s using the displayed speed, filter and gain settings. When more than 10-seconds are displayed on the screen, the earliest 10-seconds are printed.</p> <p data-bbox="453 1793 1297 1818">When the display speed is set to 50mm/s, a one page 5-second report is printed.</p>



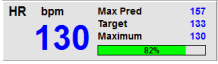

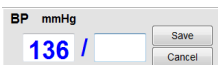

Function Key and Button	Action and Description
<p>F5 Key Averages</p> 	<p>Available for selection upon entry into the Exercise phase to generate an Averages printout for the current time. 12 average complexes are printed for each of the current time and start of exercise (when available) with 10-seconds of rhythm.</p>
<p>F6 Key Event</p> 	<p>Displays an Event pop-up window. Select an event name from the drop-down menu or enter free text and click OK to generate a 12-lead ECG. The event name text is included on the ECG printout and stored 12-lead ECG. The Event is included in the summary, final report, and minute-by-minute averaged ECG.</p> <p>Bookmark, Supine, Mason-Likar, Standing, Hyperventilation, Chest Pain, and Shortness of Breath are listed by default. Additional labels can be added in the modality settings.</p> <p>Resting ECG interpretation can be enabled or disabled in Pre-exercise phase during supine or Mason-Likar ECG acquisition.</p>
<p>F7 Key RPE</p> 	<p>Selected to define the patient's Rate of Perceived Exertion level. Either one of two user-selectable scales of 0 – 10 or 6 – 20 is defined in the modality settings menu. The displayed pop-up list begins with Nothing and ends with Maximal or very hard exercise perception, with various grades of effort in between. Select the specific rating to generate a 12-lead ECG with the selected statement appended to it.</p> 



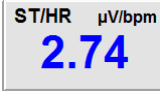

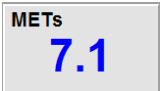
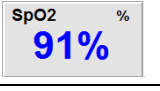
Function Key and Button	Action and Description
<p>F8 Key Rhythm Print</p> 	<p>Select to run a continuous rhythm strip. A continuous 3-channel or 6-channel printout of the leads defined in the real-time display settings. Clicking F8/ Rhythm Print when printing is in progress switches the 6-channel printout to the frontal leads (I, II, III, aVR, aVL, aVF); a second click changes the printout to the precordial leads (V1, V2, V3, V4, V5, V6); a third click switches back to the original leads. Similarly, for 3-channel printout, the printed leads will cycle through all 12 leads when the printing is in progress. The speed of the continuous rhythm strip is configured in the F2/Format dialog.</p> <p>Continuous rhythm strips contain the patient’s name, date, time, stage time, total exercise time, workload, lead labels, and calibration pulses on the first printed page.</p> <p>Generate continuous rhythm strips during Observation, Pre-exercise, Exercise, Recovery, and Final Report phases. A scheduled automatic 12-lead or manually generated event will interrupt the continuous rhythm strip.</p>
<p>F9 Key Stop Rhythm</p> 	<p>Select to stop the continuous rhythm printout.</p>
<p>F10 Key Dose</p> 	<p>Select to open a dialog allowing drug and dosage entry. Select from the drop-down lists or enter free-text. This information is added to the Notes where the entry includes the phase time and dose entries.</p>
<p>F11 Key Notes or Patient Info</p>  	<p>In the pre-exercise phase through recovery, select to open a dialog that allows entry of free-text in the Notes field. Up to approximately 200 alphanumeric characters or four lines of text can be included in the final report.</p> <p>In the recovery phase, select to display and edit the patient information and notes for the exam according to the configured format.</p>
<p>F12 Key Conclusions</p> 	<p>In the recovery phase, select to display the exercise summary information for review and to enter conclusions.</p>

Tiles

Displayed Tiles are customizable in the Modality Settings menu and can be defined differently per Group. ST/HR Index, Double Product, METs, and SpO2 may or may not be present.

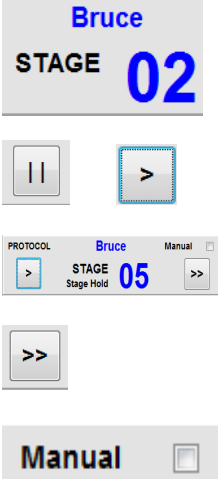
Tile Features	Description
<p>HR bpm, Max Pred, Target, Maximum</p> <p>% of Target HR graph</p> 	<p>Calculates and displays the HR bpm derived from rhythm leads V1 and V5 with lead II as a confirmation lead using a sliding average window of 16 consecutive R to R intervals.</p> <p>Max Pred (Maximum Predicted HR) and Target (Target HR) calculation with treadmill and pharmacological testing is based on age and percent of maximum predicted HR using 220 minus age, or 210 minus age, or 210 minus (0.65 x age).</p> <p>Max Pred (Maximum workload) with ergometer testing is calculated using the following formula: Max Workload Men = $6.773 + (136.141 * BSA) - (0.064 * Age) - (0.916 * BSA * Age)$ Max Workload Women = $3.933 + (86.641 * BSA) - (0.015 * Age) - (0.346 * BSA * Age)$ Where $BSA = 0.007184 * (Height ^ 0.725) * (Weight ^ 0.425)$ Age in years / Height in cm / Weight in kg</p> <p>Maximum (Maximum HR) displays the highest heart rate achieved during the exam.</p> <p>Target HR can be calculated from a range of 75% to 100% in increments of 5%. Clinicians may also manually enter the target value they would like the patient to obtain.</p>
<p>Blood Pressure Display</p> <p>Automatic</p>   <p>Manual</p>  	<p>Displays last entered or acquired BP reading. When value is updated, background display will turn yellow and an audible beep will sound. Once value is displayed on screen, it will be maintained along with a timestamp as to when it was last acquired. Value will not change until next manual or automatic entry.</p> <p>Manual BP is defined in local settings when there is no interfaced BP Equipment. The Enter BP button is used to enter SBP and DBP values.</p> <p>The type of interfaced BP equipment is defined in the local settings. Automatic BP and Manual BP entry is toggled through checkbox selection. Automatic BP will be initiated according to the selected protocol. The Start BP button will initiate a measurement.</p> <p>NOTE: Users may edit the existing value for the displayed BP measurement by selecting the Edit BP button, changing the value, and selecting the Save button. When a BP values is edited, the existing value for the measurement and time that value was entered are replaced with new values in all reported locations.</p>
<p>ST Level and Slope</p> 	<p>Displays ST value for the on-screen average complexes. When Pre-exercise phase begins, Q-Stress will acquire and analyze the incoming ECG data to develop the dominant beat template. ST LEARN... displays during this process and is replaced by the measured ST level once the dominant template is established.</p> <p>During the learning process, an Override ST Learn button is available in the zoomed ECG panel. This is useful when the patient presents a wide-QRS complex that will not be used for ST segment analysis during exercise.</p> <p>NOTE: It is very important that the patient is in the position of exercise, is relaxed, and remains very still during the ST learning process.</p>

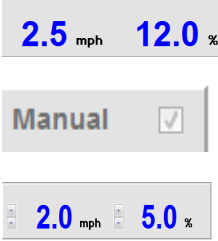
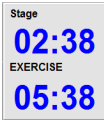

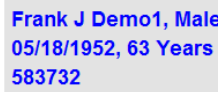
Tile Features	Description
<p>ST/HR Index</p> 	<p>Calculates and displays the ST/HR index value in $\mu\text{V}/\text{bpm}$.</p> <p>NOTE: <i>ST/HR index value displays only when Q-Stress detects a change in HR with an increase of greater than 10% and ST depression greater than 100 μV.</i></p>
<p>Double Product (DP)</p> 	<p>Calculates and displays current Double Product value (systolic BP x HR) once BP is manually or automatically entered. DP value updates dynamically when next BP is obtained and is maintained on display in relation to the BP timestamp.</p> <p>NOTE: <i>If a DP cannot be calculated due to lack of HR or BP, dashes are displayed.</i></p>
<p>METs</p> 	<p>Displays the estimated metabolic equivalents (METs). Calculation updates every 10 seconds. Once maximum METs for a stage have been achieved, the value will be maintained until stage completion. When progressing to the next stage, the METs value will equal the maximum achievable METs value of the previous stage. A linear progression of METs calculations will begin until the maximum value for the stage is reached. In manual mode, the displayed METs will update immediately as the Speed or Grade is changed.</p>
<p>SpO₂ Value</p> 	<p>Displays on-screen SpO₂ average value in percent. Value is updated every 15 seconds when the unit is attached to a manufacturer approved device.</p>
<p>STOP/START Belt</p>  	<p>Button text is green to indicate treadmill will start moving and red to stop or pause the treadmill. There is no button text when Ergometer exams are performed.</p> <p>NOTE: <i>The Treadmill can be paused (STOP BELT) during exercise to correct a faulty lead, tie a shoelace, etc. as needed. When the treadmill is started again, the workload will gradually resume and a stage hold is placed.</i></p> <p>Select the Stage Hold  button to resume the protocol's automatic control.</p>

Tile Features	Description
<p>Protocol and Stage</p> 	<p>Indicates the protocol name currently being used for the stress exam and the current exercise stage.</p> <p>To change to a different protocol, click on the protocol name and a drop-down list appears. When a different protocol is selected during exercise, exercise will advance to the next stage of the selected protocol.</p> <p>This button toggles to Hold  the current stage and  to resume stage progression according to the programmed stage time. Stage Hold is displayed when selected.</p> <p>Advance to the next stage. This selection is functional during routine protocol progression and when a Stage Hold has been selected.</p> <p>To Manually control exercise or recovery, enable the checkbox and then click on the Speed/Grade values. When Manual is enabled in the Exercise phase, manual control will continue through the Recovery phase.</p>
<p>Treadmill Speed/Grade %</p> 	<p>The MPH or KPH (speed) and percent (elevation/grade) for the current workload settings of the treadmill are displayed when using a treadmill protocol.</p> <p>Once the Manual checkbox is enabled, up/down arrows appear next to the mph and % values allowing manual control. Control is manual from that point on for the remainder of the exam.</p> <p><i>NOTE: When the treadmill is off and a printout is made, dashes will print next to MPH and %.</i></p>
<p>Time Display</p> 	<ul style="list-style-type: none"> • The Pre Exercise clock starts upon Pre-exercise phase entry. • Upon entry into the Exercise phase, the Pre-exercise timer is replaced by the Stage and EXERCISE timers. • Upon entry into Recovery, the Stage timer is replaced with the Recovery timer and the EXERCISE timer stops and freezes.
<p>Watts, RPM, Maximum Power, and Target Power</p> 	<p>The current workload settings of the ergometer are displayed when using an ergometer protocol. Watts is displayed from 0 to 950.</p> <p><i>NOTE: If the ergometer is off and a printout is made, dashes will print next to Watts.</i></p>
<p>Patient Information</p> 	<p>Entered patient demographics are always displayed.</p>

Panels

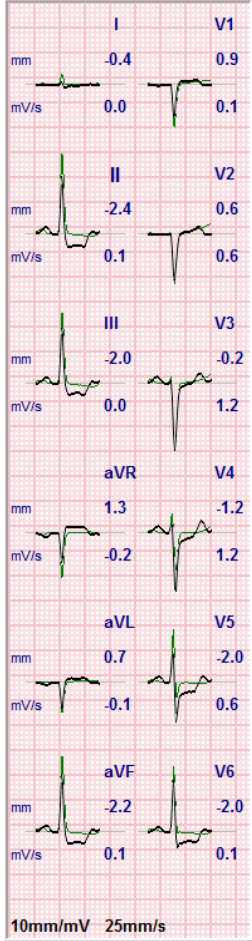
Some panels can be toggled between hidden and shown. Arrow buttons allow quick selection to show more real-time ECG. The 12 ECG averages and real-time ECG will always be shown.

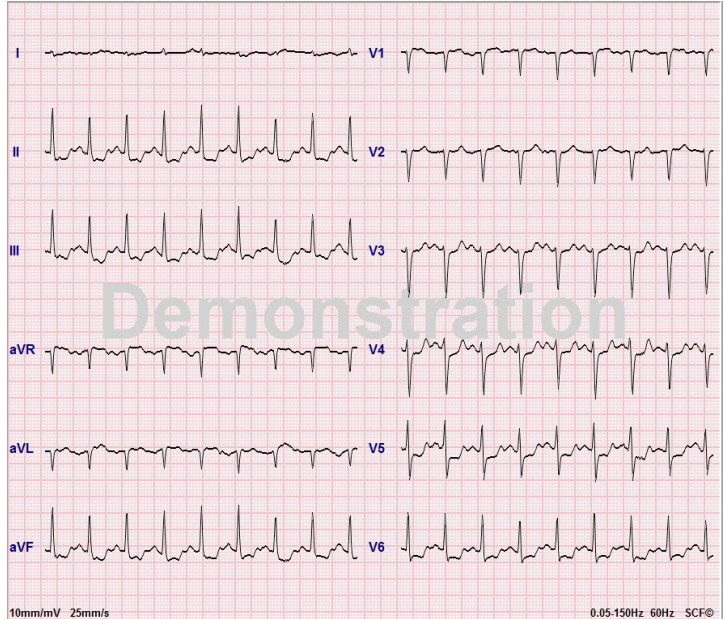
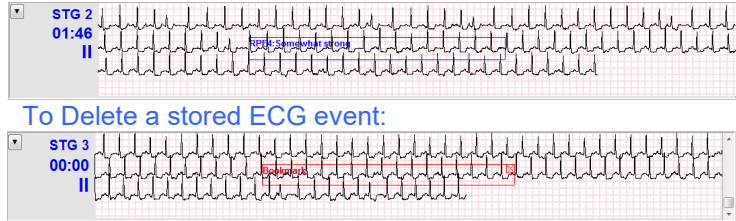
Panel Features	Description																																							
<p>ECG Averages</p>  <p>The image shows a grid of 12 ECG lead waveforms. Each lead is labeled with its name and corresponding ST level and slope measurements. The leads are arranged in two columns: I, V1, II, V2, III, V3, aVR, V4, aVL, V5, aVF, and V6. The ST level is shown in mm and the slope is shown in mV/s. At the bottom, the scale is indicated as 10mm/mV and 25mm/s.</p> <table border="1"> <thead> <tr> <th>Lead</th> <th>ST Level (mm)</th> <th>Slope (mV/s)</th> </tr> </thead> <tbody> <tr> <td>I</td> <td>-0.4</td> <td>0.0</td> </tr> <tr> <td>V1</td> <td>0.9</td> <td>0.1</td> </tr> <tr> <td>II</td> <td>-2.4</td> <td>0.1</td> </tr> <tr> <td>V2</td> <td>0.6</td> <td>0.6</td> </tr> <tr> <td>III</td> <td>-2.0</td> <td>0.0</td> </tr> <tr> <td>V3</td> <td>-0.2</td> <td>1.2</td> </tr> <tr> <td>aVR</td> <td>1.3</td> <td>-0.2</td> </tr> <tr> <td>V4</td> <td>-1.2</td> <td>1.2</td> </tr> <tr> <td>aVL</td> <td>0.7</td> <td>-0.1</td> </tr> <tr> <td>V5</td> <td>-2.0</td> <td>0.6</td> </tr> <tr> <td>aVF</td> <td>-2.2</td> <td>0.1</td> </tr> <tr> <td>V6</td> <td>-2.0</td> <td>0.1</td> </tr> </tbody> </table> <p>10mm/mV 25mm/s</p>	Lead	ST Level (mm)	Slope (mV/s)	I	-0.4	0.0	V1	0.9	0.1	II	-2.4	0.1	V2	0.6	0.6	III	-2.0	0.0	V3	-0.2	1.2	aVR	1.3	-0.2	V4	-1.2	1.2	aVL	0.7	-0.1	V5	-2.0	0.6	aVF	-2.2	0.1	V6	-2.0	0.1	<p>All 12 averaged ECG complexes are displayed with superimposition of current and reference data. The ECG lead label with ST level and slope measurements below each label are also displayed.</p> <p>This panel is always displayed.</p> <p>A click on any of the ECG Average in this display will change the Zoomed ST lead when that panel is displayed.</p>
Lead	ST Level (mm)	Slope (mV/s)																																						
I	-0.4	0.0																																						
V1	0.9	0.1																																						
II	-2.4	0.1																																						
V2	0.6	0.6																																						
III	-2.0	0.0																																						
V3	-0.2	1.2																																						
aVR	1.3	-0.2																																						
V4	-1.2	1.2																																						
aVL	0.7	-0.1																																						
V5	-2.0	0.6																																						
aVF	-2.2	0.1																																						
V6	-2.0	0.1																																						

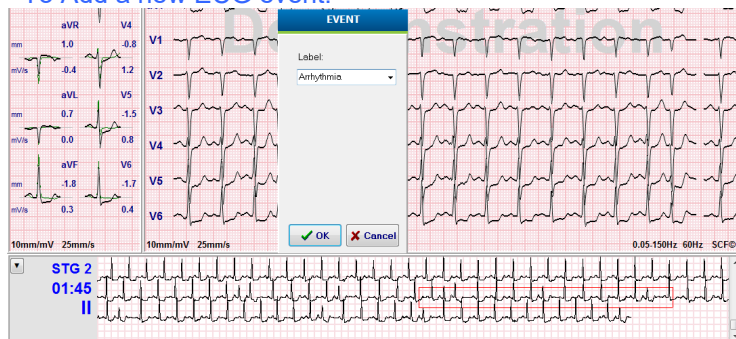
Panel Features	Description
<p>Real-time ECG</p> 	<p>3 leads, 6 leads, 12 leads (12x1), or 12 leads (6x2) are displayed in real time with their respective lead labels.</p> <p>This panel will increase/decrease in total ECG seconds displayed according to other shown panels.</p> <p>This panel is always displayed.</p> <p>NOTE: A click on the real-time ECG will open a menu allowing selection of displayed lead layout, Gain, Speed, and Filter change for the current patient.</p>
<p>Context View</p>  <p>To Delete a stored ECG event:</p>  <p>To Add a new ECG event:</p> 	<p>Displays a miniature single ECG lead when enabled. The phase or stage together with the time is displayed in blue text.</p> <p>Choose the displayed lead by a click on the lead label when a drop-down list appears.</p> <p>A scroll bar is used to move back and forward in time from pre-exercise through the recovery phase. When scrolling back in time, the display will return to the current time after 60-second of no activity.</p> <p>Stored 12-lead ECGs are highlighted and labeled in a blue box that can be edited with a click. The blue box changes to red with an X in the upper right corner. Click on the X to delete the stored ECG.</p> <p>Double-click the ECG to add an ECG event and choose a label from the Event drop-down list or enter free text. The Bookmark label allows a quick selection that can be edited later.</p>

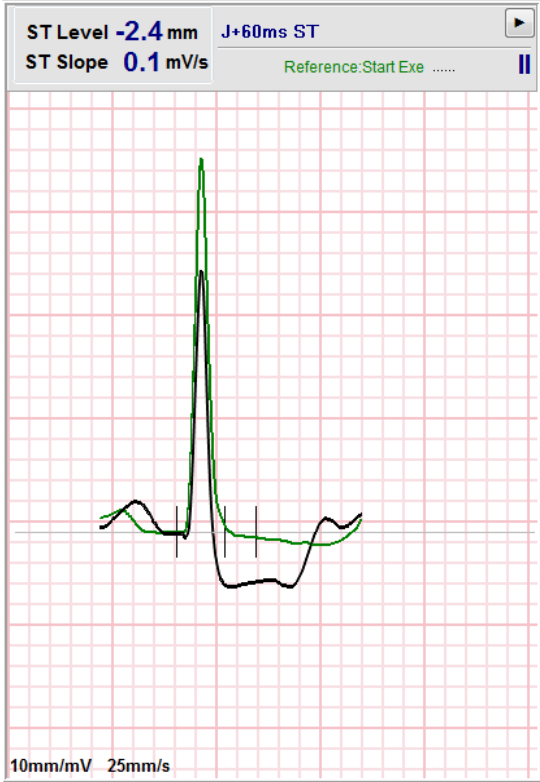
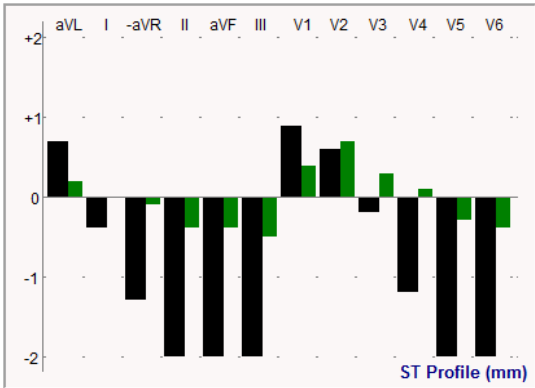
Panel Features	Description
<p>Zoomed ST</p>  <p>ST Level -2.4 mm J+60ms ST ST Slope 0.1 mV/s Reference:Start Exe</p> <p>10mm/mV 25mm/s</p>	<p>One expanded average complex with superimposition of current and reference data. ST level in mm or μV and ST slope measurement in mV are also displayed. The zoomed ECG can be shown / hidden on display. The same selected ST lead is also shown in the ST change trend.</p> <p>Tick marks are displayed on the QRS complex to show isoelectric, J-point, and ST measurement points.</p> <p>NOTE: A click on the Zoomed ECG will open a menu allowing selection of a different lead, different reference, addition of ST baseline markers, ability to move the isoelectric and J-point for any needed correction, and a Relearn of the dominant beat morphology.</p>
<p>ST Profile</p>  <p>ST Profile (mm)</p>	<p>Displays ST value for the on-screen average in a graph format. When Exercise begins, Q-Stress will acquire and analyze the incoming ECG data to develop the current ST level at the beginning of the procedure. The graph displays the current ST levels in black and the reference levels in green.</p> <p>NOTE: A click on the ST Profile will open a menu allowing change between Last Rhythm Event, ST Profile, and Profile and Event.</p>

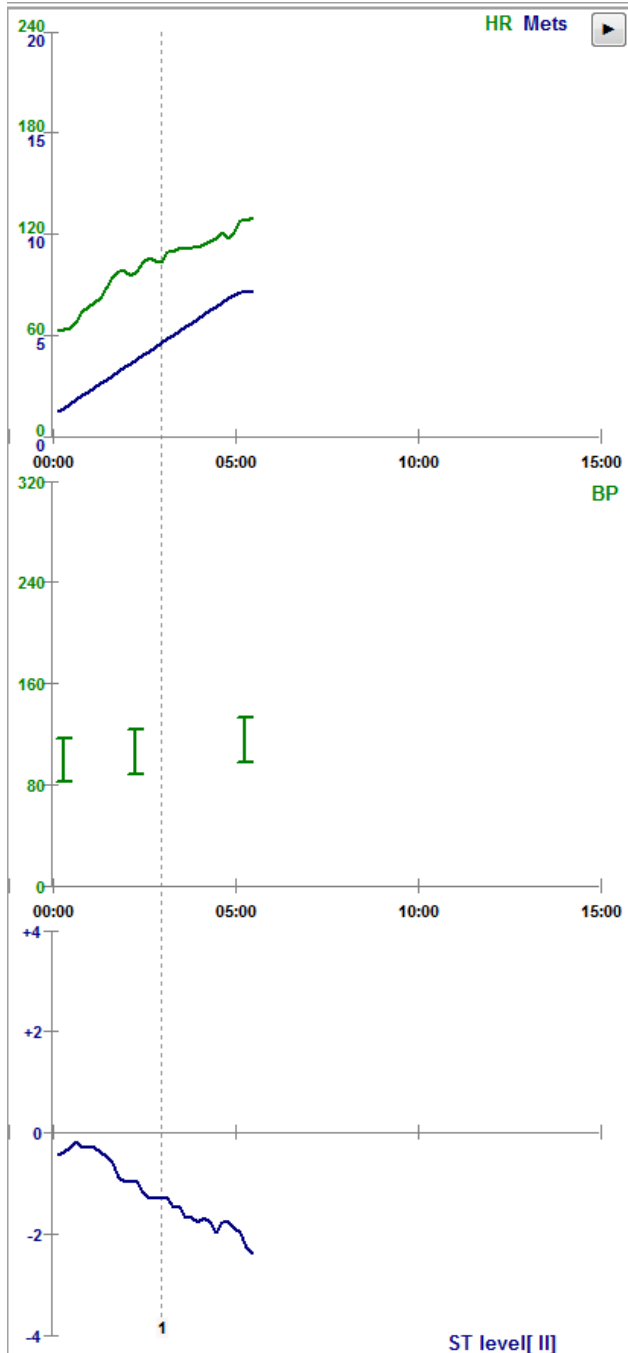
Panel Features	Description																				
<p data-bbox="207 306 750 338">Heart Rate, METs, BP and ST Level Trends</p>  <p>The figure consists of three vertically stacked line graphs sharing a common x-axis representing time from 00:00 to 15:00. A vertical dashed line is positioned at 05:00. The top graph shows Heart Rate (HR) in green and METs in blue. The middle graph shows BP values in green with error bars. The bottom graph shows ST level in blue.</p> <table border="1"> <caption>Approximate data points from the trends</caption> <thead> <tr> <th>Time</th> <th>HR (bpm)</th> <th>METS</th> <th>BP (mmHg)</th> <th>ST level (mV)</th> </tr> </thead> <tbody> <tr> <td>00:00</td> <td>60</td> <td>5</td> <td>80</td> <td>0</td> </tr> <tr> <td>05:00</td> <td>120</td> <td>10</td> <td>120</td> <td>-2</td> </tr> <tr> <td>15:00</td> <td>180</td> <td>15</td> <td>160</td> <td>-4</td> </tr> </tbody> </table>	Time	HR (bpm)	METS	BP (mmHg)	ST level (mV)	00:00	60	5	80	0	05:00	120	10	120	-2	15:00	180	15	160	-4	<p data-bbox="961 405 1409 493">This dual trend shows Heart Rate (HR) trend and values in green and METs level trend and values in blue.</p> <p data-bbox="961 863 1435 951">The middle trend shows non-invasive blood pressure (BP) values as they have been entered during exercise and recovery.</p> <p data-bbox="961 1289 1409 1346">The bottom trend represents ST levels for the current zoomed ECG lead.</p> <p data-bbox="961 1472 1425 1560">All trends are updated every 10 seconds and will automatically resize depending on exam duration.</p> <p data-bbox="961 1598 1414 1686">The time axis starts at the start of exercise and goes to 15, 30, 60, 90 or 120-minutes depending on length of the exam.</p>
Time	HR (bpm)	METS	BP (mmHg)	ST level (mV)																	
00:00	60	5	80	0																	
05:00	120	10	120	-2																	
15:00	180	15	160	-4																	

11. CONDUCTING A STRESS TEST

Patient Preparation

Before attaching the electrodes, ensure the patient fully understands the procedure and what to expect.

- Privacy is very important to ensure the patient is relaxed.
- Explain the method to be taken for skin preparation and electrode application.
- Make sure the patient is comfortable and that the arms and hands are relaxed.
- Once all the electrodes are attached and quality is checked for good signal, ask the patient to relax and remain still to assist in good baseline ECG acquisition.

Preparing Patient Skin

Thorough skin preparation is very important. There is natural resistance on the skin surface from various sources such as hair, oil, and dry, dead skin. Skin preparation is intended to minimize these effects.

To prepare the skin:

- Shave chest hair at the electrode sites if necessary.
- Clean skin with alcohol or warm, soapy water to remove body oils, lotion and powder.
- Thoroughly wipe the skin dry with gauze or a towel.
- Gently exfoliate the skin with an abrasive pad where the gel center of each electrode will be applied.

Patient Hookup

Attach the electrodes to the lead wires on the patient cable or acquisition module before attaching electrodes to the patient.

To Attach the Electrodes

1. Firmly attach each lead wire to an electrode.
2. Place the gel area of the electrode over the center of the prepared area using the positioning illustrated in figure 4; press the adhesive ring into place. Avoid pressing the center of the gel area.
3. Place right arm (RA/R) and left arm (LA/L) leads close to the shoulder on the clavicle bone.
4. Place right leg (RL/N) and left leg (LL/F) leads on the lower portion of body, as close to the hip as possible, on the iliac crest (original Mason-Likar position), or on the lowest rib on each side of the chest (modified Mason-Likar position).
5. Ensure electrodes are securely attached to the skin. To test electrode contact, lightly tug the lead wire to check adhesion. If the electrode moves freely, the site should be prepped again. If the electrode does not move easily, a good connection has been obtained.



NOTE AND CAUTION: *Proper skin preparation is very important. Poor ECG signal quality is the main cause for incorrect beat and arrhythmia detection. RA and LA are susceptible to muscle interference. RL and LL leads are susceptible to interference from clothing, a belt, and movement.*





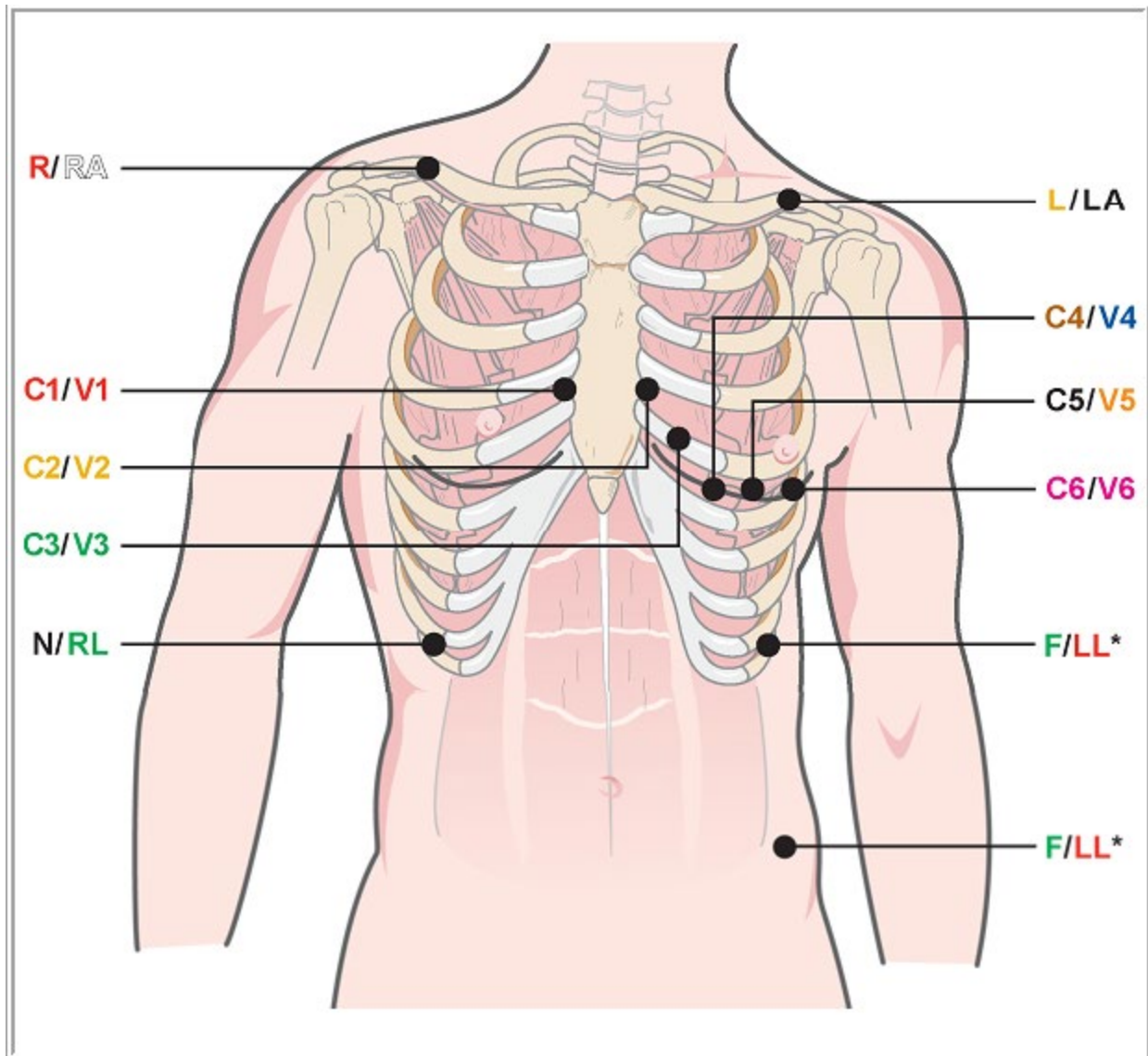







Choose the best locations for limb lead placement according to body type. Avoid muscular and loose, flabby skin locations.

Prevent pulling on the lead wires by means of strain relief as needed with use of surgical tape or a stress vest available from most medical supply companies.

Figure 4 Electrode Positioning

NOTE AND CAUTION: Placement of the Left Leg (LL) electrode in the original Mason-Likar position increases the similarity of the acquired ECG with a standard 12-lead ECG and is therefore recommended; however, clothing may interfere with this position and increase the amount of artifact. The modified position may decrease the sensitivity of inferior ECG leads and cause axis shift with respect to the standard 12-lead ECG. Accurate skin preparation and suitable clothing are the most important factors in excessive artifact prevention.

Patient Hookup Summary Table

AAMI Lead	IEC Lead	Electrode Position
Red	 Red	On the 4 th intercostal space at the right sternal border.
 Yellow	 Yellow	On the 4 th intercostal space at the left sternal border.
 Green	 Green	Midway between V2/C2 and V4/C4 electrodes.
Blue	Brown	On the 5 th intercostal space at the left midclavicular line.
 Orange	 Black	Midway between V4/C4 and V6/C6.
 Violet	 Violet	On the left midaxillary line, horizontal with V4 /C4 electrode.
Black	Yellow	On the left clavicle.
 White	 Red	On the right clavicle.
 Red	 Green	Place on lower left side of body, as close to the hip as possible, or on the lowest rib on the left side of the chest; see Note and Caution*.
Green	Black	Place on the lower right side of the body on the lowest rib on the right side of the chest.

Lead Impedance Check

Before moving to the pre-exercise phase, electrodes may be checked to verify a satisfactory connection. The Q-Stress Impedance Check is recommended during the Observation phase.

Select the **Impedance Check** button to have the program check the quality of each electrode connection. A window will open showing your electrode connections.

NOTE: Impedance Check is only available when the Q-Stress patient cable is selected as the front end.

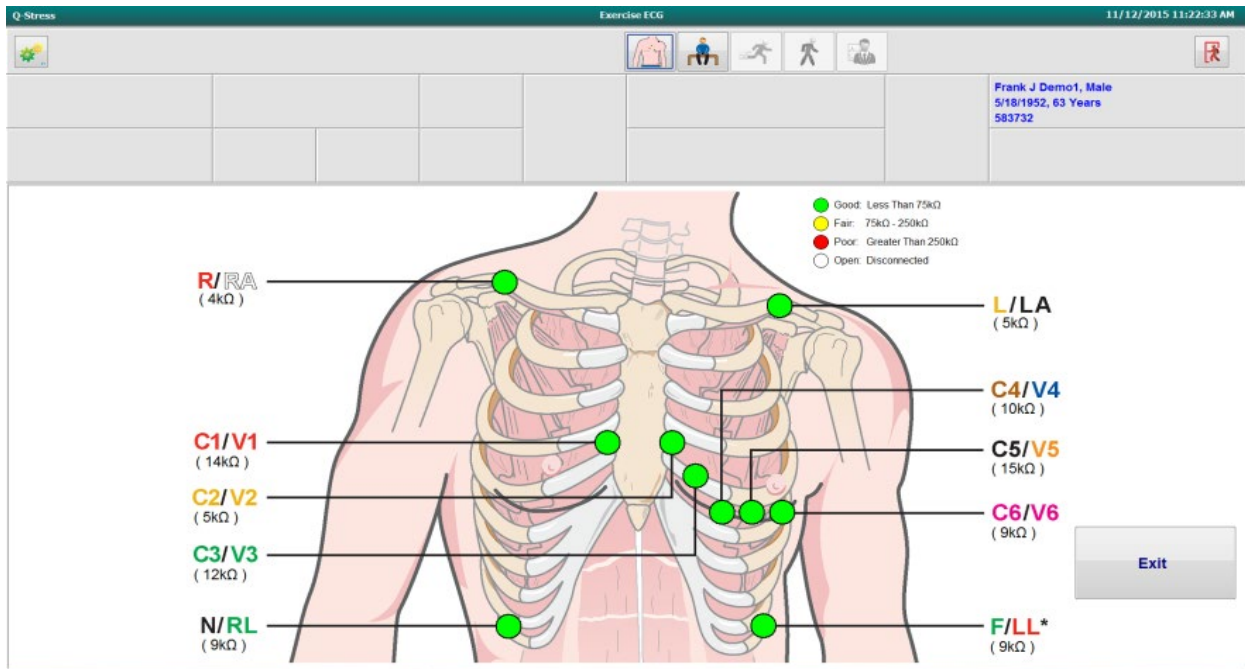

Color	Connection Quality	Impedance (kΩ)
Green	Good	Less than 75
Yellow	Fair	75 – 250
Red	Poor	Greater than 250
White	Open (disconnected)	--

Re-prep the site(s) and replace the electrode(s) until you have confirmed good connection, then select the **Exit** button.

NOTE: There is a 5-second delay where no waveform is present on the observation screen after exiting the Impedance Check display and returning to real-time ECG display.

Start a Stress Test

Select the Start a Stress Test icon to open the MWL/Patients window.

- When scheduled orders exist, the MWL tab is automatically selected.
- When no scheduled orders exist, the Patients tab is automatically selected.

Scheduled Order(s)

1. When there is an existing order for the patient, highlight the patient in the MWL list.

The Exam Information section on the left side of the display is populated by the previously entered patient demographics.

Height, Weight, Admission ID, and other exam information fields can be populated. Target HR is calculated according to the Max HR and percent selected (75% to 100%) to determine a submaximal HR.

Max Workload and Target Workload are calculated using age, height and weight. These values are used for ergometer exams.

***NOTE:** Max HR, Target HR, Max Workload, and Target Workload values can also be manually entered as desired.*

Exam Information

Group: Cardiology

Last Name: Unger, First Name: Richard
 Middle Name: B., Gender: Male, Race: Caucasian
 DOB: 2/21/1973, Age: 42 Years
 Height: 70 in, Weight: 195 lb
 ID: 328323, Second ID: 532-34-2853
 Admission ID: 1000376
 Address: 283 West Oak Street, City: Grafton, WI, USA
 Home Telephone: 262-343-2853, Work Telephone: 800-382-9987
 Mobile Telephone: 262-342-3882, Email Address: RU@yahoo.com

Angina: Typical (No), History of MI: No, Indications: R/O CAD
 Prior Cath: No, Prior CABG: No
 Smoking: Yes, Diabetic: No, Medications: Antihypertensive, Diuretics, Beta Blockers
 Family History: Yes, Pacemaker:

Referring Physician: Dr. T. Ryan, Notes: Beta Blockers held for 24-hours, Allergic to Penicillin
 Procedure type: Treadmill Stress Test, Location: EXG Lab 2
 Max HR: 178 bpm, Target HR: 151 bpm (85%), Requested Date/Time: 11/16/2015 02:30:00 PM
 Max Workload: 206 W, Target Workload: 206 W (100%)
 Technician: Roger Franks, RCVT, Attending Phy: Dr. R. Collins

Patients

Scheduled Date/Time	Patient ID	Last Name	First Name	Date of Birth	Group
11/18/2015 01:45:00 PM	858923	Kanabec	Franklin	8/22/1957	Radiology
11/17/2015 10:00:00 AM	984353	Hansen	Sarah	2/14/2006	Children's Clinic
11/16/2015 02:30:00 PM	328323	Unger	Richard	2/21/1973	Cardiology
11/16/2015 10:00:00 AM	867343	Jackson	Martha	7/30/1954	Cardiology

Buttons: Start Exam, Clear, Exit

2. Enter any desired exam information on the left panel and select **Start Exam**.

No Scheduled Order(s)

When no scheduled orders exist, the Patient tab is automatically selected.

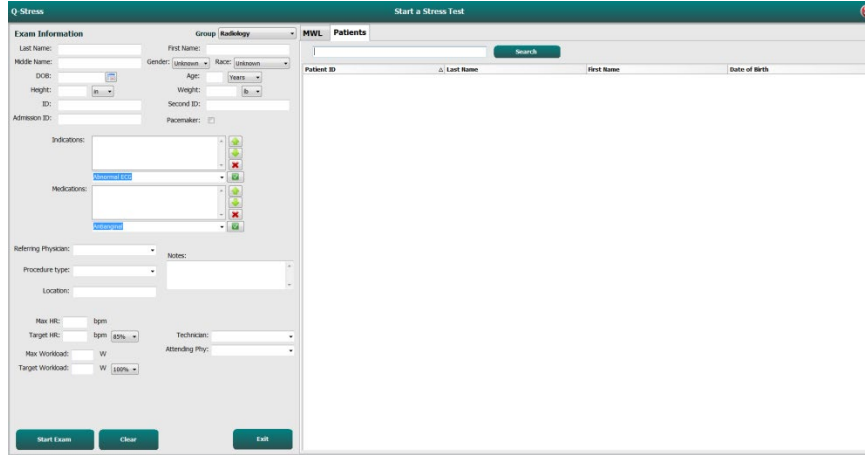

1. Search for existing patients in the database by entering a name or ID number, and then select the **Search** button.
2. When the patient is not found, enter any desired patient and exam information on the left panel.

***NOTE:** If the entered ID number already exists in the database, a warning will appear informing you to click OK to continue or Cancel to correct the entered demographics.*

Enter date of birth by typing MM/DD/YY or DD-MM-YY according to the computer regional settings, or by clicking on the calendar icon. Select the decade and the year; use the left/right arrows to scroll the year, the month, and the day to populate the field. Age will be automatically calculated.



Q-Stress will remember list items such as Indications, Medications, Procedure Type, and Referring Physician as they are entered. The added items will be available for future selection. Enter text or choose items from the drop-down menu and then click on the green checkmark to enter. Use the red **X** to delete the selected item. When there are multiple entries, items can be moved up or down by using the green arrow keys.

Some fields are not available (grayed) when patient demographics are attached to existing exams in the database or are ordered by an external system.

3. Select **Start Exam** after demographic information is complete and the observation phase of the stress exam is displayed.

Observation Phase

4. Check the ECG signal quality:

The observation window displays the lead placement diagram and acquired ECG waveforms. By default, Q-Stress displays real-time ECG waveform in a 6x2 format.

- Examine the 12-lead rhythm display for artifact (noise), or baseline drift. Re-prep and replace electrodes as necessary to obtain satisfactory tracings. (See [Patient Preparation](#).)
- If a lead fail condition exists in any of the displayed leads, a square wave appears for that lead on the display and the lead in fault displays in red letters in the upper right corner of the screen together with a LEAD FAIL message. In instances of simultaneous, multiple lead fail conditions, Q-Stress gives display priority to the limb leads, followed by leads V1 through V6.

ECG/F3 and continuous Rhythm/F8 can be printed during this phase but will not be stored with the exam.

- ### 5. Select Impedance Check to ensure leads are connected and conducting signal adequately. Re-prep and replace electrodes as necessary to obtain satisfactory impedance values (Green with less than 75 k Ω). When finished, Exit to return to the Observation screen.

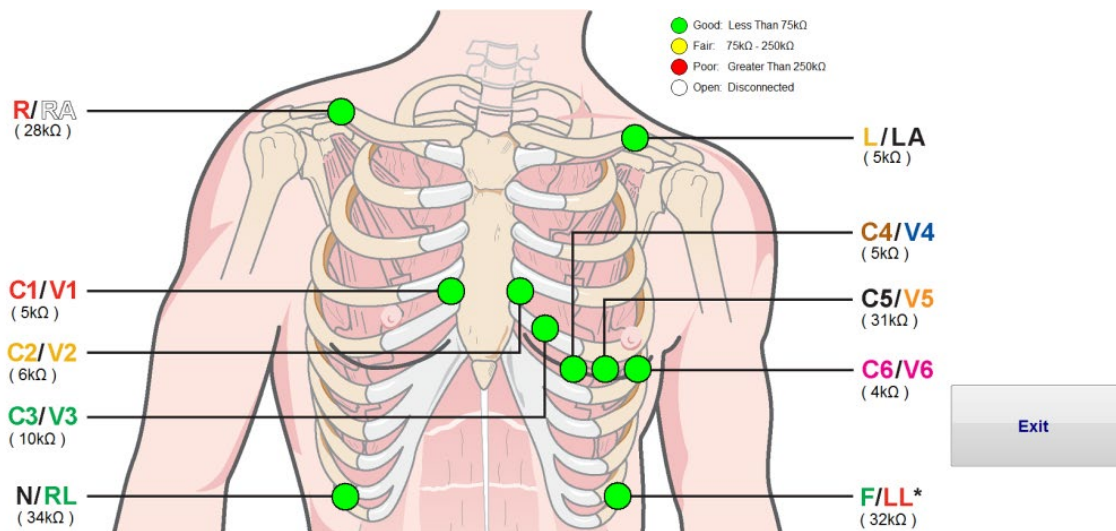

Local Settings



Select **Settings** or press **F1** to change any of the Equipment settings if needed.

Station Name: Computer name by default; may be user-configured

Front End: Q-Stress or WAM

(WAM Pairing button appears when WAM is selected)

Trigger Module: ECG A or ECG B

Exer Equipment: Trackmaster 425, Trackmaster 428, Trackmaster (no sensing), TM55, TM65, Ergoline, Lode Corival, Medical Positioning

BP Equipment: Manual, Tango, Tango M2, Ergoline, Lode Corival

AC Frequency: 50 or 60

COM Port: Assigned ports and available listing

Selected settings are remembered when the next exam is started.

To Pair the WAM

- Select **Local Settings** and choose **WAM** as the Front End.
- Select the **WAM Pairing** button.
- Select **OK**.
- Place the WAM (powered off) in close proximity to the UTK receiver connected to the Q-Stress USB port.
- Turn WAM on.
- A successfully paired message will display.
- Select **OK**.

***NOTE:** Ending the stress exam will automatically cause the WAM to power off. It is not necessary to pair the WAM with the same UTK to use it again.*

***NOTE:** LED indication is not available when using WAM with Q-Stress.*

***NOTE:** 12-Lead ECG and Rhythm Print buttons are non-functional when using WAM with Q-Stress.*

Protocol Selection and Advance to Pre-Exercise



- Select the Pre-Exercise button when ready to enter the Pre-exercise phase and the following prompt appears on the display.

NOTE: The noise cancelling Source Consistency Filter (SCF) is very effective but **MUST LEARN EACH PATIENT'S OPTIMAL ECG CONFIGURATION WHILE IN THE POSITION OF EXERCISE WITH A NOISE FREE SIGNAL.**

Ensure these conditions are met when entering the Pre-exercise phase.

Keep the patient motionless until the ST Learn... and SCF Learning messages disappear.

- The appropriate Protocol selection is identified prior to starting the exam using the drop-down menu in the Advance to Pre-Exercise prompts in the Observation phase display. To change to a different protocol, click and scroll through the drop down list.

Protocols can be modified using the Modality Settings located in the System Configuration menu. This is explained in the [System Configuration](#) section of this user manual.

Highlight and select the desired **Protocol**.

NOTE: Manual control of any exercise protocol during the test is always available; however, this may cause the Q-Stress to exit the current protocol.

- Select the **Proceed** button to move to Pre-exercise or select the **No** button to remain in Observation until all criteria are met. Then select the Pre-Exercise button again when ready.

Pre-Exercise Phase

The Q-Stress acquires ECG data to develop the patient's cardiac template used for heart rate calculation, ST segment analysis, and arrhythmia detection. ST learning begins and the SCF filter begins to learn, if enabled, upon entry into Pre-exercise.

NOTE: Attempt to maintain a motionless patient in the position that will be assumed during stress testing while the SCF and ST are learning. This will ensure a clean and clear signal during the stress test. A message will appear at the top right-hand side of the display with notification that the SCF filter is in the process of learning. Once this message disappears the SCF has completed its learning process indicating that it's okay for the patient to move.



The Pre-exercise phase time clock starts and the HR and ST level for the expanded lead displays after learning along with the zoomed average complex.

During the Pre-exercise phase, the user should:

1. **Start** an automatic BP or select **Enter BP** to type the patient's baseline BP by button selection.
 - Entry of three characters in the systolic field automatically advances the cursor to the diastolic field.
 - An automatic timestamp as to when the BP was entered will appear below the BP values.
2. Obtain event documentation (i.e., supine, standing, and hyperventilation 12-lead ECGs) as desired.
3. Instruct patient on the proper technique for using the exercise equipment.
4. If desired, change the exercise display options by a click on the real-time ECG to open the waveform control menu.

ST LEAD

The ST-Level, ST Slope, ST measurement point, ST Reference, zoomed ECG lead label and waveform are shown in the ST Zoom panel. Any of the 12 leads can be manually selected by a click on any one of the ECGs in the Averaged ECG panel. In addition, the zoomed lead can be selected dynamically (most significant elevation or depression), by Max Depression, by Max Elevation, by Max ST/HR Index, or by ECG lead using ST Lead menu drop-down list.

During the Pre-exercise phase (only), the J-ST measurement point can be adjusted up or down in the ST Lead menu. This selection is not available during exercise and recovery phases.

Note: The ST measurement point can be modified and the entire exam reanalyzed using the changed ST measurement point after the exam is completed.

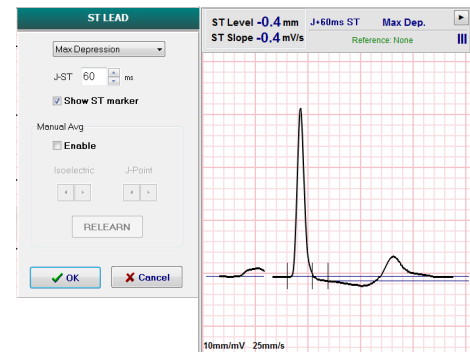

Manual Average (Avg) and Relearn

Prior to starting the exercise portion of the test it is recommended that the ECG template be re-learned if the patient had been supine when the ST Learning occurred and moves to an upright position. To avoid ECG template differences caused by positional changes, click on the zoomed ST to open the **ST LEAD** menu. A spatial magnitude complex is displayed representing the summation of high-frequency signal magnitudes (vector sum) for all 12 leads. Click the **Enable** checkbox and click the **RELEARN** button to initiate an adjustment.

Relearn initiates an automatic relearn of a new dominant QRS complex. This is useful for positional changes as well as QRS morphology changes. A dominant rhythm change (DRC) is displayed on the trends after a relearn.

To adjust the QRS onset and offset any time after the ST is learned, click the **Enable** checkbox and adjust the isoelectric and J-point tick marks right or left and then select the **OK** or **Cancel** button to close the window. Each click represents a change of two milliseconds. Once adjustments are made and **OK** is selected, all ST measurements are updated and a warning symbol  appears near the displayed ST value. 12-lead ECGs obtained after a change will reflect the updated measurement points.

Override ST Learn

When the patient presents with a wide QRS rhythm such as bundle branch block or ventricular paced rhythm, the ST learning process will not complete and the zoomed ECG will remain flat lined. The wide QRS rhythm may also be detected as a ventricular rhythm.

If after waiting a minute the ST is not learned, select the **Override ST Learn** button to proceed with the exam. The Zoom ST/ST Profile panel will become hidden and ST analysis is disabled. In addition, ST averages at the right of the display will remain flat-lined and ventricular arrhythmia event capture is disabled. A message will inform you of the consequences of the ST override and will prompt with an **OK** or **Cancel** selection.

When the wide QRS rhythm is present throughout the exam, the final report will not report ST level and maximum ST values will contain dashes.

When the wide QRS rhythm converts to a normal QRS during the exam, the ST for the normal beats is learned and reported for the times the patient remained in a normal rhythm.

Waveform Control and Using Filters

Left-click anywhere in the real-time ECG to open a window allowing you to set displayed ECG leads, filters, display gain, and display speed.

Filters listed below may be enabled or disabled at any time during the exam:

- Source consistency filter (SCF)
- 40 Hz filter
- AC filter

Source Consistency Filter (SCF)

Welch Allyn's patented Source Consistency Filter (SCF) is an exclusive feature used for reducing noise associated with stress testing. Using the morphology learned during the Pre-exercise phase or during a relearn operation, the SCF distinguishes between noise and the actual signal in each of the 12 leads. This filtering reduces muscle tremor noise, low-frequency and high-frequency noise, and baseline artifact while preserving diagnostic-quality waveforms.

The default state of the filter (enabled or disabled) is determined by the modality settings. When the filter is on, SCF[®] appears in the lower border of the real-time ECG display. This setting can be changed at any time during a stress exam.

AC Filter

The AC filter removes line frequency noise by removing frequencies in a narrow band around 60 Hz (domestic) or 50 Hz (international). The default state of the filter (enabled or disabled) is determined by the selected profile. When the filter is on, 60 Hz or 50 Hz appears in the lower border of the real-time ECG display. This setting can be changed at any time during a stress exam.

40 Hz Filter

The 40 Hz filter is a plot filter, meaning that it affects only the plotted/printed information similar to a 40 Hz filter on an electrocardiograph. The default state of the filter (enabled or disabled) is determined by the selected profile. When the filter is on, 40 Hz appears in the lower border of the real-time ECG display. This setting can be changed at any time during a stress test.



WARNING: When the 40 Hz filter is used, the frequency response requirement for diagnostic ECG equipment cannot be met. The 40 Hz filter significantly reduces high-frequency components of the ECG and pacemaker spike amplitudes, and is recommended only if high-frequency noise cannot be reduced by proper procedures.

Acquiring a Resting ECG

Q-Stress allows for the acquisition and printing of a 12-lead resting ECG while the patient is in a supine position. A Mason-Likar labeled ECG may also be acquired as a baseline for comparison throughout the exam. Enable or disable interpretation by checkbox in the Pre-exercise phase of the exam by using **Event** or **F6**.

1. Have the patient rest on a bed or exam table. If the exam table is narrow, tuck the patient's hands under his/her buttocks to ensure arm muscles are relaxed.
2. Click on the **EVENT** button , select **Supine**, and then click **OK**.
3. After a few seconds, Q-Stress will print a full 12-lead resting ECG including measurements and interpretation text if so selected. The printout format is defined in the modality settings menu.
4. Have the patient stand and move to the treadmill or ergometer. Click on **EVENT**, select **Standing** or **Mason Likar**, and then click **OK**.

Settings

Select the  **Settings** button or press the **F1** key to change 3- and 6-lead ECG combinations, change the ECG print speed, change the default Sync lead and enable/disable arrhythmia printout.

Arrhythmia printouts will continue to store for inclusion in the final report when this selection is disabled.

Changes will affect this patient only and will revert to the default defined in the Modality Settings configuration for the next exam.

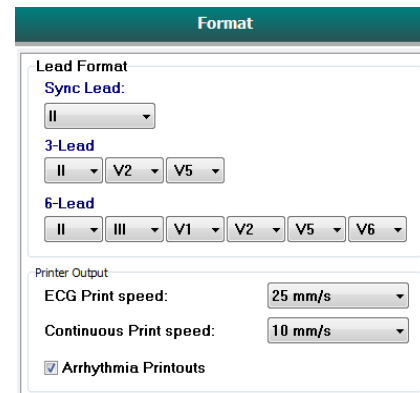

The screenshot shows the 'Format' settings window. It is divided into three sections: 'Lead Format', 'Printer Output', and 'Arrhythmia Printouts'. Under 'Lead Format', there is a 'Sync Lead' dropdown menu set to 'II'. Below that are '3-Lead' and '6-Lead' sections, each with dropdown menus for lead selection. The '3-Lead' section has dropdowns for 'II', 'V2', and 'V5'. The '6-Lead' section has dropdowns for 'II', 'III', 'V1', 'V2', 'V5', and 'V6'. Under 'Printer Output', there are two dropdown menus: 'ECG Print speed' set to '25 mm/s' and 'Continuous Print speed' set to '10 mm/s'. At the bottom, there is a checkbox labeled 'Arrhythmia Printouts' which is currently checked.

Instruct the Patient

Before beginning the Exercise phase of the test, instruct the patient to follow the appropriate steps below:

For Treadmill

1. Have the patient straddle the belt. (Turn the treadmill on only when the belt has been safely straddled). Highlight and click on **START BELT**. The treadmill starts at the pre-selected speed and elevation.
2. Patient should place hands on the handrail for stability and test the speed of the belt with one foot before transferring the other foot to the moving belt.
3. When acclimated to the movement of the belt, remind patient to keep body straight with head up. Wrists can rest over the handrail or arms at their sides as in a normal walking position.
4. Instruct patient to relax, using as little upper-body motion as possible, and stay near the front of the treadmill.

NOTE: When using a treadmill and an emergency occurs, depress the emergency stop button mounted on the handrail to stop the treadmill immediately.

For Ergometer

1. Have the patient sit on the ergometer seat. Highlight and click on **START Ergometer**. The ergometer load starts at the pre-selected Watts level.
2. Patient should place hands on the handlebars for stability and test the watts level of the ergometer before proceeding ensuring familiarity with the functional requirements during the test.
3. When acclimated to the ergometer, remind patient to keep their body straight with head up. Wrists can be rested over the handlebars as in a normal riding position.

NOTE: It is recommended to **Abort** the exam and **Begin** again if waiting more than one hour to begin exercise. This prevents unnecessary data storage, however previously stored full disclosure, ECG events, and BP values are not saved when an exam is aborted.



Select the Exercise button  when ready to enter the Exercise phase.

Exercise Phase

Exercise begins according to the selected protocol.

- The stage time clock and the total exercise time clock will start counting from 00:00.
 - The treadmill or ergometer advances the workload according to the protocol definitions for the first stage of exercise or the Time and METs ramp protocols will progress within a single stage.
1. Allow the Q-Stress to acquire ECGs at the defined times set by the current protocol.
 2. Allow the automated BP device to obtain BP readings at the protocol defined times, or manually acquire and enter BP values as prompted or required.
 3. Enter notes, drug doses, and acquire manual ECGs or rhythm strips as needed throughout this phase.
 - Select the ECG/F3 key to generate a 12-lead ECG printout
 - Select the Write Screen/F4 key to print a 10-second page of real-time ECG
 - Select the Averages/F5 Key to generate a printout showing start of exercise averaged ECG compared to the current averaged 12-lead ECG
 - Select the Event/F6 Key to store and document ECG Events with a label
 - Select the RPE/F7 Key to document the patient's rate of perceived exertion
 - Select the Rhythm Print/F8 Key to print continuous rhythm and Stop/F9 Key to stop printing rhythm
 4. Hold and advance protocol stages as needed.

NOTE: The Treadmill can be paused (**STOP BELT**) during exercise to correct a faulty lead, tie a shoelace, etc. as needed. When the treadmill is started again, the workload will gradually resume and a stage hold is placed. Toggle the Stage Hold  button to continue the protocol's automatic control.



Select the Recovery button  when the exercise endpoint is reached and the Recovery phase is to begin.

The Recovery phase will be entered automatically when the patient reaches the end of the last stage or the linear ramp protocol threshold is reached when the protocol is programmed to automatically begin Recovery at end of Exercise.

Recovery Phase

Recovery is manually entered by clicking on the Recovery button while in the Exercise phase. The Recovery phase may also be started automatically if the protocol is programmed to automatically begin Recovery at end of Exercise. (Refer to [System and User Configuration](#) for details.)

The treadmill will change to the specified recovery speed and grade or ergometer to the specified Watts level, and then turn off once the recovery period has been completed. Depending on the programmed Recovery Rate, the treadmill or ergometer may ramp down during the recovery period and stop at the end of the programmed Recovery Time. ECG, BP, and Dose intervals will begin and automatically occur according to programmed protocol times.

The treadmill can also be manually stopped by clicking on the **Stop Belt** button. A manual stop will place a Hold on the Recovery Duration graph showing percent of completion; however timed ECG, BP, and Dose intervals will continue as programmed.

At the start of the Recovery phase, the stage timer is replaced by the Recovery timer and the exercise timer stops and freezes at the total exercise time. An automatic Peak ECG generates (when moving from “Exercise” to “Recovery” a Peak Exercise is always generated regardless of settings).

Menu items function in recovery as they did in exercise; however, the user can also edit the Patient Information and Notes /F11 key or Conclusions / F12 key (Diagnosis, Reasons for test end, Symptoms, Conclusions, Technician, and Attending Physician) in Recovery.

Automatic BP prompts and ECGs continue as programmed. Enter BP values, drug doses, and acquire manual ECGs or rhythm strips as needed throughout this phase.

Select the ECG/F3 key to generate a 12-lead ECG printout

Select the Write Screen/F4 key to print a 10-second page of real-time ECG

Select the Averages/F5 Key to generate a printout showing start of exercise averaged ECG compared to the current averaged 12-lead ECG

Select the Event/F6 Key to store and document ECG Events with a label

Select the RPE/F7 Key to document the patient’s rate of perceived exertion

Select the Rhythm Print/F8 Key to print continuous rhythm and Stop/F9 Key to stop printing rhythm



At the end of the Recovery phase, select the **End Exam** button to enter the Final Report phase. The program will prompt you to confirm **Exit Test?** Select **OK** to confirm end of Recovery or **Cancel** to continue.

Final Report Phase

When the Recovery phase is ended, Q-Stress advances to the Report Manager display.

- A real-time, 7.5-second ECG channel displays in the lower left portion of the display.
 - The displayed lead can be changed to a different lead
 - A 12-lead ECG or rhythm strip can be printed
- Summary section presents total exercise time, maximum speed, and maximum grade or Watts as well as leads with greater than 100 μV of ST change.

Percent of Functional Aerobic Impairment, or FAI %, is present when a Bruce protocol has been conducted.

The Duke Score, a quantitative exercise treadmill score for predicting prognosis at Duke University, is present when a Bruce protocol has been conducted and the patient presents ST change during the exam. Clinical assessment of the Duke Score can be chosen from a drop-down list with the following Angina selections that will affect the resulting value:

- No angina
- Non-limiting angina
- Exercise-limiting angina
- The ST Change Snapshot provides a Heart Rate and ST Change dual-trend with a red bar showing where ST Change was greater than 100 μV . The trended lead can be changed using the drop-down menu.
- Max values section presents Max HR, Target HR and METs achieved. Max values are followed by Double Product, maximum systolic and diastolic BP.
- Max ST values section presents elevation, depression, total change, and ST/HR Index.
- Conclusions section allowing entry of Diagnosis, Reasons for End, Symptoms, Conclusions, Technician, and Attending Physician using free-text or drop-down lists.

- The Conclusions field can be populated with acronyms with a click on the  button and selection from the list or, when the acronyms have been memorized, entry of a forward slash, the abbreviation, and spacebar selection (e.g. /C10[spacebar] will enter “No ST Changes”).
- The Conclusions field can be populated with a narrative paragraph that will parse summary labels and values from the current exam results. There are 9 templates to choose from:
 - Normal Treadmill Test,
 - Abnormal Treadmill Test,
 - Equivocal Stress Test,
 - Uninterpretable Stress Test,
 - Normal Ergometer Test,
 - Abnormal Ergometer Test,
 - Normal Pharmacological Test, and
 - Abnormal Pharmacological Test.

Select the desired template and then the green check button to populate the conclusions field. Once selected and entered, the narrative text can be modified as needed by the clinician.

- Post Processing allows an adjustment of the ST measurement point. The entire exam will be reanalyzed for ST change when the J-ST milliseconds value is changed and the ST Modify button is selected.
- The Final Report can be previewed and printed as desired.
- The entire exam can be reviewed beat-by-beat through selection of the Page Review button.

Quick Start: System Selection to Start a Stress Test

Click on this button to open the Start a Stress Test window presenting MWL (all scheduled exams) and the Patients tabs on the right portion of the display.

The Patients tab is selected when no exams have been scheduled.



The Search field can be used to search for existing patient demographics or an MWL order, depending on the selected tab.

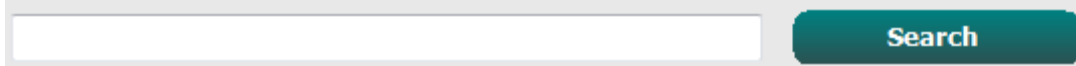

The Clear button will remove all entered Exam Information from the left portion of the display allowing you to enter new information.



The Exit button will return you to the main menu.



Edit or add information using free text or drop-down lists as needed, and then select the **Start Exam** button.



The Q-Stress observation phase begins.

Quick Start: System Display during the Observation Phase



The Observation button is highlighted with a blue border. This phase can be aborted  at any time to return to the Start a Stress Test window.

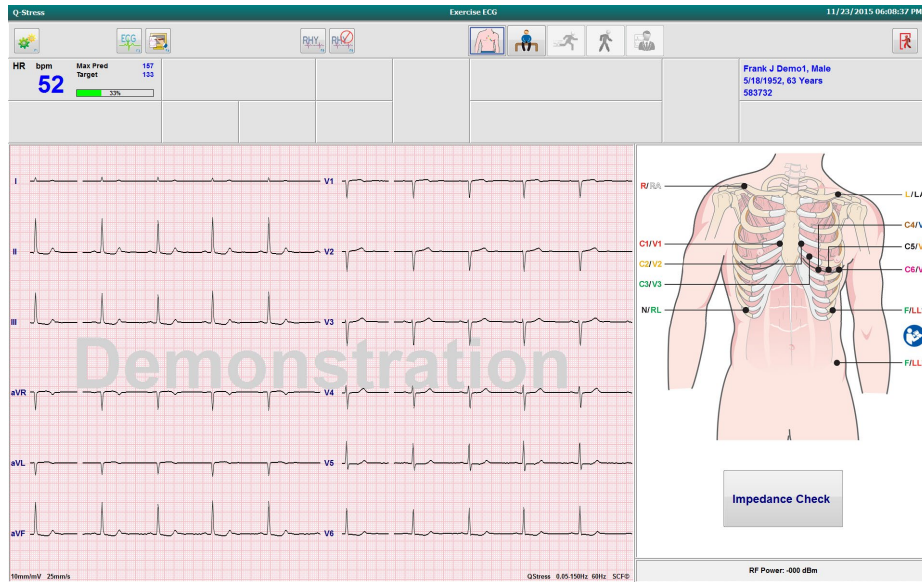

Check ECG waveform quality and lead placement, and then select **Impedance Check**.

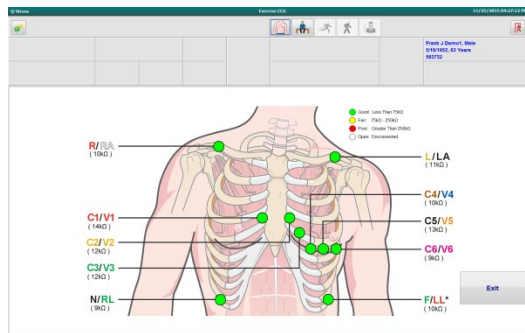

Ensure leads are conducting signal appropriately and lead colors are green, then select the **Exit** button.

Have the patient remain still and relaxed, and then select the **Pre Exercise** button .

You are prompted to select the protocol once the Pre-Exercise button is selected. Select Proceed when all criteria is met.

Quick Start: System Display during the Pre-exercise Phase





The Pre Exercise button is highlighted with a blue border. This phase can be aborted  at any time to return to the Start a Stress Test window. The Pre Exercise timer begins showing mm:ss.

Wait while the Source Consistency Filter (SCF) is learning to distinguish between noise and the cardiac signals. Wait while the ST learning is in progress. These processes take about a minute. The Exercise phase button is not available until the ECG averages are learned and displayed.

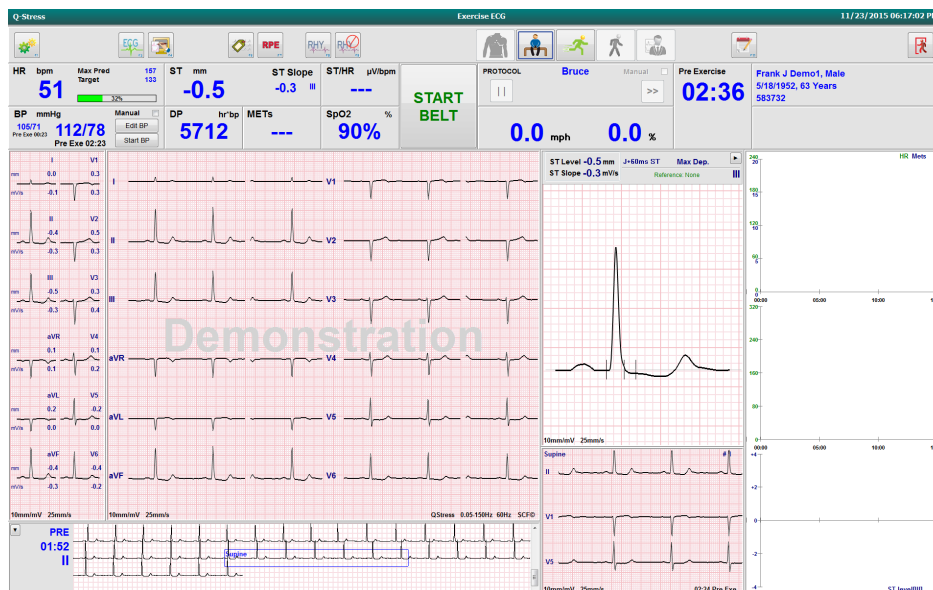

Acquire a baseline BP measurement and ECGs as needed. Use the Event/F6  button to select labels, print, and store the baseline ECG events. You may start/stop the belt to demonstrate treadmill walking before exercise start.



Have the patient straddle the treadmill belt before starting it, and then select the **Exercise** button. 

Quick Start: System Display during Exercise Phase



The Exercise button is highlighted with a blue border. The Pre Exercise timer is replaced with Stage and total Exercise timers, both starting at 00:00, and the exercise proceeds automatically, according to the protocol.

Panels can be shown or hidden as desired.

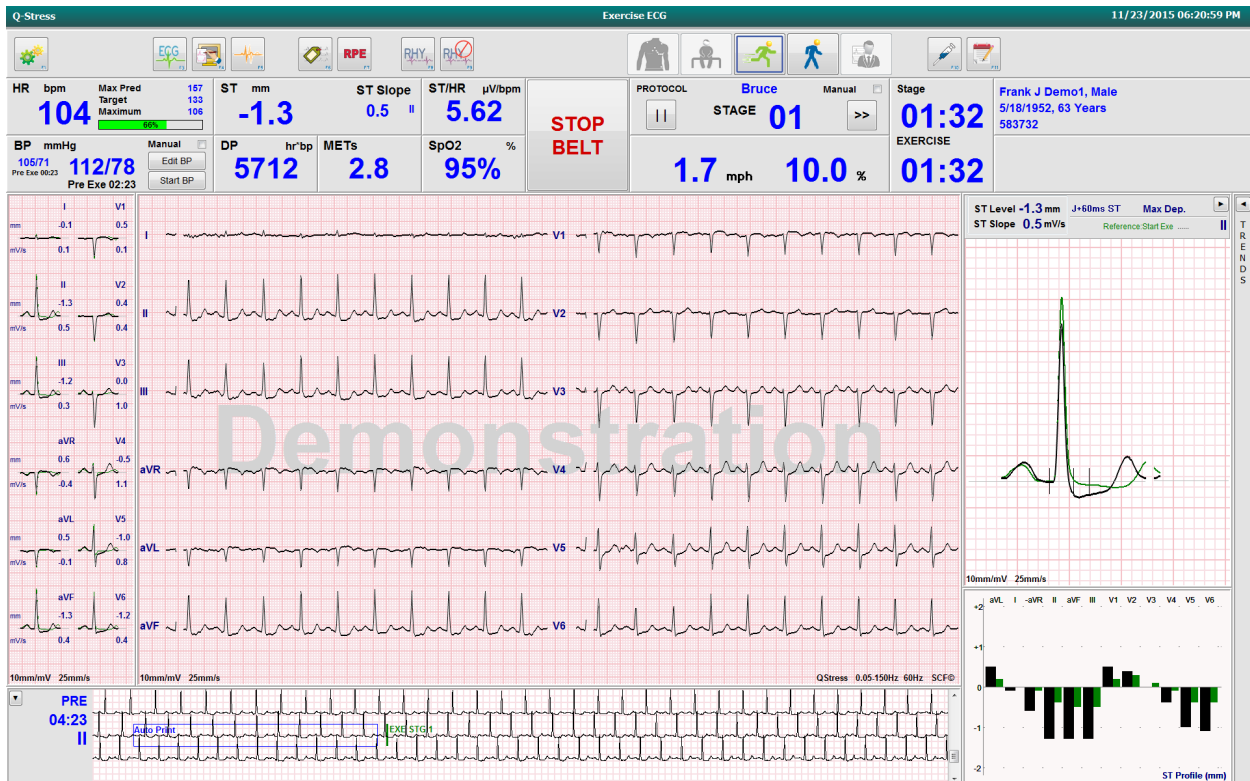

Enter notes, drug doses, and acquire manual ECGs, rhythm strips, or BPs as needed throughout this phase.

As this phase progresses, the HR tile displays the target and the Maximum heart rate achieved at the current exam time. The graph represents the current percent of the Maximum Predicted HR.

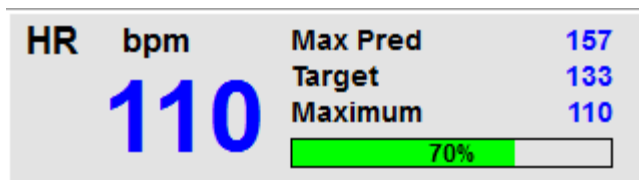

When ready to end exercise, select the **Recovery** button or allow the exercise phase to complete when the protocol has been programmed to automatically begin Recovery upon completion of all exercise stages.

Quick Start: System Display during Recovery Phase



The Recovery button is highlighted with a blue border. The Stage timer is replaced with the Recovery timer starting at 00:00 and the total Exercise timer is frozen.

The Patient Information and Conclusions buttons appear in this phase allowing for results preparation.

Recovery will proceed automatically according to the protocol with auto ECGs and BPs taken. The treadmill grade and speed will decrease according to the programmed recovery phase. A Recovery Duration graph showing the percent of recovery achieved is displayed. When STOP BELT is selected, the graph will stop reporting the percent.

While the patient is recovering, the physician or clinician may wish to begin final report preparations. Select the



Conclusions button to choose from drop-down lists and enter free text, acronyms, or narrative templates. The Summary and Max Values are not editable during Recovery. When finished, select the OK button to save changes or Cancel to exit the Conclusions without saving your changes and return to the full Recovery display.

The screenshot displays the Q-Stress software interface during the Recovery phase. Key elements include:

- Top Bar:** Q-Stress, Exercise ECG, 11/23/2015 06:23:14 PM
- Vital Signs:** HR 127 bpm, BP 128/93 mmHg, DP 14336 hr*bp, METs 3.8, SpO2 91%, ST -2.0 mm, ST Slope 0.2, ST/HR 0.2.
- Recovery Phase:** Recovery Duration 11%, Recovery timer 00:42, EXERCISE timer 03:03. A "STOP BELT" button is visible.
- ECG:** Multiple lead waveforms (I, II, III, aVR, aVL, aVF, V1-V6) are shown.
- Summary:**
 - Exercise Time: 03:03
 - Max Speed: 2.5 mph
 - Max Grade: 12.0%
 - Leads over +/- 100 µV: V6
 - Duke Score: -4
 - Angina: None
 - FAI %: 52-54
- Max Values (ST measurements based on J+60ms):**
 - ST Elevation: +1.1 mm (03:00)
 - ST Depression: -2.0 mm (03:00)
 - ST Elevation Change: -0.9 mm (03:10)
 - ST Depression Change: -1.4 mm (03:00)
 - ST/HR Index: 5.62 µV/bpm (01:30)
- Diagnosis and Symptoms:** Ischemic ECG is selected under Reasons for End, and Chest Pain is selected under Symptoms.
- Conclusions:** Abnormal_Treadmill_Test is selected.
- Technician:** Roger Franks, RCVT
- Attending Phy:** Dr. E. Williamson

When ready to end the Recovery phase and enter the Report Manager, select the **End Exam** button.

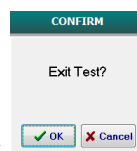

A prompt will require OK selection to exit.

Quick Start: Report Manager Display



The End Exam button is highlighted with a blue border prior to moving to the Report Manager display. Patient Information and Conclusions edits in Recovery are brought forward.

Real-time ECG is displayed for a single lead and ECG can be printed when the patient is still connected.

Further editing and change is possible in this display in addition to the ability to change Summary, Max Values, and Max ST measurement values as needed.

The ST Change Snapshot dual-trend shows HR and ST change for the selected lead. The red bar graph represents where greater than 100 μV of ST change occurred from exercise through recovery.

The screenshot shows the 'Report Manager' window for a patient named Frank J. Demo. It includes a table of 'Max Values' and 'Max ST (ST measurements based on J-STm)' with columns for Exercise Time, Max Speed, Max Grade, Leads over $> 100 \mu\text{V}$, Duke Score, Age, and Fat %. The 'ST Change Snapshot' section displays a dual-trend graph for HR and ST Change. The 'Real Time ECG' section shows a live ECG trace for lead V5. The right-hand column contains 'Conclusions', 'Reasons for End', 'Symptoms', and 'Post Processing' options like 'Print Options', 'ST Modify', and 'Page Review'.

Right Column Selections

- Patient Data** Click to open and edit patient demographics data.
- Print Options** Choose desired printer for the final report and Page Review printouts.
- Preview** Choose to display, print, and customize the final report pages.
- Post Processing** **J-ST** and **ST Modify** allow a rescans using a different ST measurement point.
- Page Review** Allows full disclosure event editing and navigation by event, trend click, and paging.
- Exit** Closes report manager and prompts for an exam state in the Finalize Exam window.

The 'Next State' dropdown menu is open, showing options: 'Acquired', 'Acquired Filled', 'Not Reviewed', and 'Signed Copies'. The 'Signed Copies' option is selected. Below the dropdown is a 'Report Settings' dropdown set to 'Cardiology' and an 'Update' button.

Using Report Manager

Patient Data

Patient demographic data may be entered now by clicking **Patient Data**. The Patient Demographics pop-up window will appear. Enter changes and then click the **OK** button to save and close.

Print Options

Use the Print Options drop-down menu to choose the desired printer when printing ECG from the real-time ECG and when in Page Review. The printer defined in modality settings will be selected by default.

Preview

Select **Preview** and the first report page is displayed in the Report Viewer.

The screenshot shows the 'Report Viewer' window with a sidebar on the left containing a 'Cardiology' section with various report options like 'Patient Information', 'Exam Summary', 'Rate/HR/Workload Trends', etc. The main content area displays the following information:

Patient Information 11/23/2015 06:14:25 PM
Bruce

ID: 583732 Second ID: 432-35-2632 Admission ID: 1000864

Date of Birth: 5/18/1952	Height: 68 in	Address: 41 North Woods Avenue	City: Milwaukee	State: WI
Age: 63 Years	Weight: 205 lb	Postal Code: 53223	Country: USA	Email Address: FJD@yahoo.com
Gender: Male	Race: Caucasian	Home Tel.: 414-252-6893	Work Tel.: N/A	Mobile Tel.: N/A

Angina: Typical History of MI: No Indications: R/O CAD Medications: Antihypertensive, Beta Blockers, Diuretics
 Prior CABG: No Prior Cath: No
 Diabetic: No Smoking: No
 Family History: Yes

Referring Physician: Dr. E. Lawler Location: ECG Lab 2 Procedure Type: Treadmill Stress Test
 Attending Phy: Dr. E. Williamson Target HR: 133... (85%) Reasons for end: Ischemic ECG, MD Discretion
 Technician: Roger Franks, RCVT Symptoms: Chest Pain

Diagnosis: Indicative for Myocardial Ischemia Notes: Beta Blockers held for 24-hours, Allergic to latex

Conclusions: The patient was tested using the Bruce protocol for a duration of 03:03 mm:ss and achieved 4.6 METs. A maximum heart rate of 149 bpm with a target predicted heart rate of 112% was obtained at 05:10. A maximum systolic blood pressure of 138/102 was obtained at 05:20 and a maximum diastolic blood pressure of 138/102 was obtained at 05:20. A maximum ST depression of -2.7 mm in II occurred at 05:10. A maximum ST elevation of +1.4 mm in aVR occurred at 05:10. Exercise stress test indicative for myocardial ischemia. ST-segment depression of more than 2mm with slow return to baseline indicates coronary artery disease exists. Abnormal exercise stress test.

Reviewed by: UNCONFIRMED REPORT Signed by: _____
 Date: _____

Q-Stress 6.1.0.38074 Hospital name here... Page 1

Report Viewer Tool Bar



Use the Windows printer icon to open a printer dialog and choose defined printers with properties, print range, and number of copies. To print the final report, select **OK**. When the Z200+ writer is present, the selection is also available for a single report printout.

Use the magnifying glass icon to choose Auto to fit the window or a percentage size for display.

Use the page icons to select a single-page, two-page, or four-page preview. The number of report pages is shown as xx / xx (displayed page number per total pages). The red arrow keys allow you to preview the next page or the previous page, as well as move to the last page or the first page.

Use the settings tool  to:

- Define the Summary and ECG Averages to be reported **By Stage** or **By Minute**,
- Define the Averages format to include 3-leads or 12-leads,
- Choose to enable/disable arrhythmia event printouts, and
- To print ECG with or without grid.

Select **OK** to save your changes and update the displayed report.

Use the pink grid icon  to toggle the displayed ECG grid background on or off. An X appears when the grid is off.

Report Options

When Report Options have been defined in Modality Manager Report Settings, a drop-down list is available for selection in the Preview window. Choose a report type and the sections are automatically compiled with sections enabled or disabled.

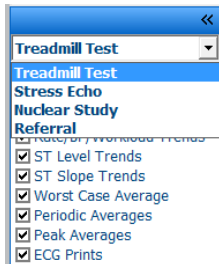

Sections

Use the checkboxes to choose sections for inclusion or exclusion in the final report. Select the arrows  in the bottom left corner of the display to refresh the displayed report after a change is made.

Exit the Preview

Click on the red **X** to close the report preview and return to the Report Manager window.





Post Processing

To rescan the stress exam using a different ST measurement point, use the up/down arrows to define a new **J-ST** value and click **ST Modify**. All ST measurements will be adjusted to reflect the new measurement point.

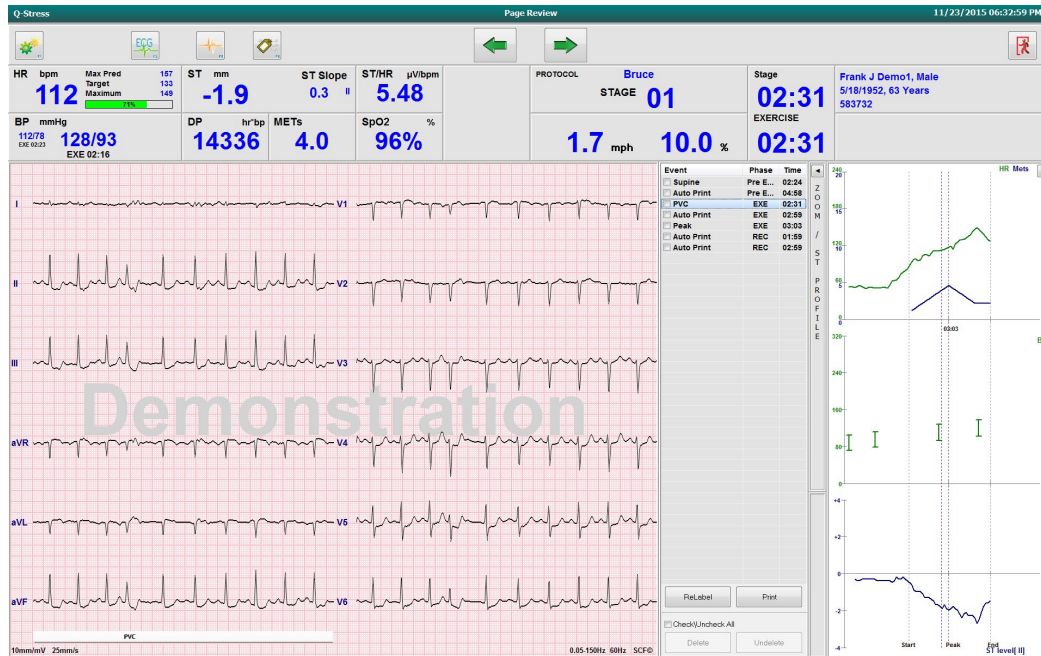
Page Review

This function allows review of saved ECG events as well as the ability to relabel, print, and delete them. New ECG events may also be added. Page review may take place immediately after ending the stress test or at a later date by selecting the Search icon. From the Report Manager screen, select **Page Review**. ECG data is displayed at the left half of the display and the following commands are available.



- End the page review session and return to Report Manager by selecting the **Exit**  button.
- Move the ECG back in 10-second increments by selecting the back arrow  or page up keyboard key. Use the keyboard left arrow key to move back in 1-second increments.
- Move the ECG forward in 10-second increments by selecting the forward arrow  or page down keyboard key. Use the keyboard right arrow key to move forward in 1-second increments.
- Add a new event by selecting **EVENT/F6**  and then choose an event label or free text a new label.
- Open a dialog to change the Gain, Display speed, Lead Layout, and 40 Hz filter by selecting the ECG waveform.
- Change the ST Lead by selecting the **Zoomed ST** and choose from the menu drop-down list.
- Change the reference ECG by selecting the green **Reference:** text and choose from the drop-down list.
- **Display, Print, Relabel, Delete,** and **Undelete** ECG events by selecting them from the Event panel and then choosing the desired buttons. You may use the checkbox to check all events and then selectively uncheck the ones you want to save or delete.

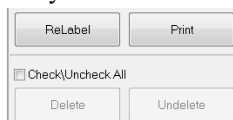

- Navigate to a specific exam time by clicking anywhere on the trend graph. A violet vertical dotted line indicates the current displayed ECG within the test.

Conclusions: Narrative Template

A narrative conclusion can be inserted into the conclusions field through selection of the Template drop-down list and then the checkmark button at the left of the template name. Upon selecting the desired template, the conclusions window will automatically populate with the appropriate summary data and will be included in the final report.

Once the template is added, it can be manually modified as needed in the Conclusions field.

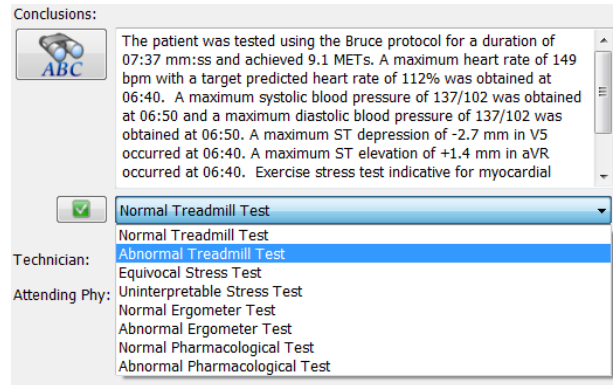

Conclusions: Acronyms

Click on the acronym icon to open a list of pre-defined acronyms and their statements. When the acronym is known, a forward slash followed by the acronym can be entered into the conclusion field (e.g., /C10) followed by a spacebar press.

Exit Report Manager and Finalize the Exam

Select the **Exit**  button to save changes and close the Report Manager window. A window opens displaying the exam information and prompts for selection of the status to **Finalize Exam Update**. The next logical status is displayed and can be changed using the drop-down menu.

User defined Report types may also be selected in this window.

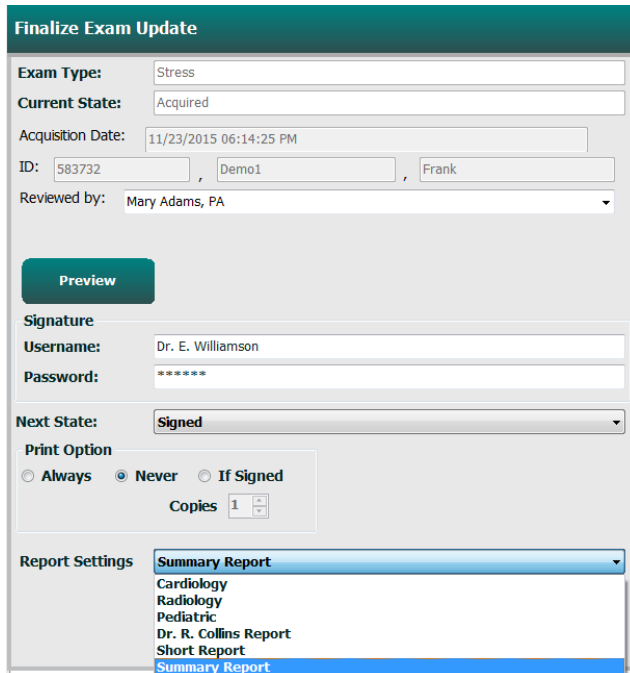

Depending on how the modality settings are defined, there are four possible states:

1. **Acquired** indicates that the exam has been completed and is waiting for the clinician to confirm or modify results.
2. **Edited** indicates the reviewer has examined the results and prepared the exam for review.
3. **Reviewed** indicates that an authorized user has confirmed the results are correct.
 - When selected, a **Reviewed By** field will open for reviewer's name entry.
4. **Signed** indicates that the exam results are correct and no further processing is necessary.
 - When selected, both a **Username** and **Password** field must be completed by a user with signing authority (if Legal Signatures is set to **yes** in the system settings).

Selecting **Always** or **If Signed** from the **Print Option** selections will automatically generate a printout of the final report. The report will print to the selected **Printer Device** when the selected state is updated.

Preview opens the final report display with details explained on the previous pages.

Select **Update** to save the next state selection and close the **Finalize Exam Update** window and return to the **Start a Stress Test** menu.

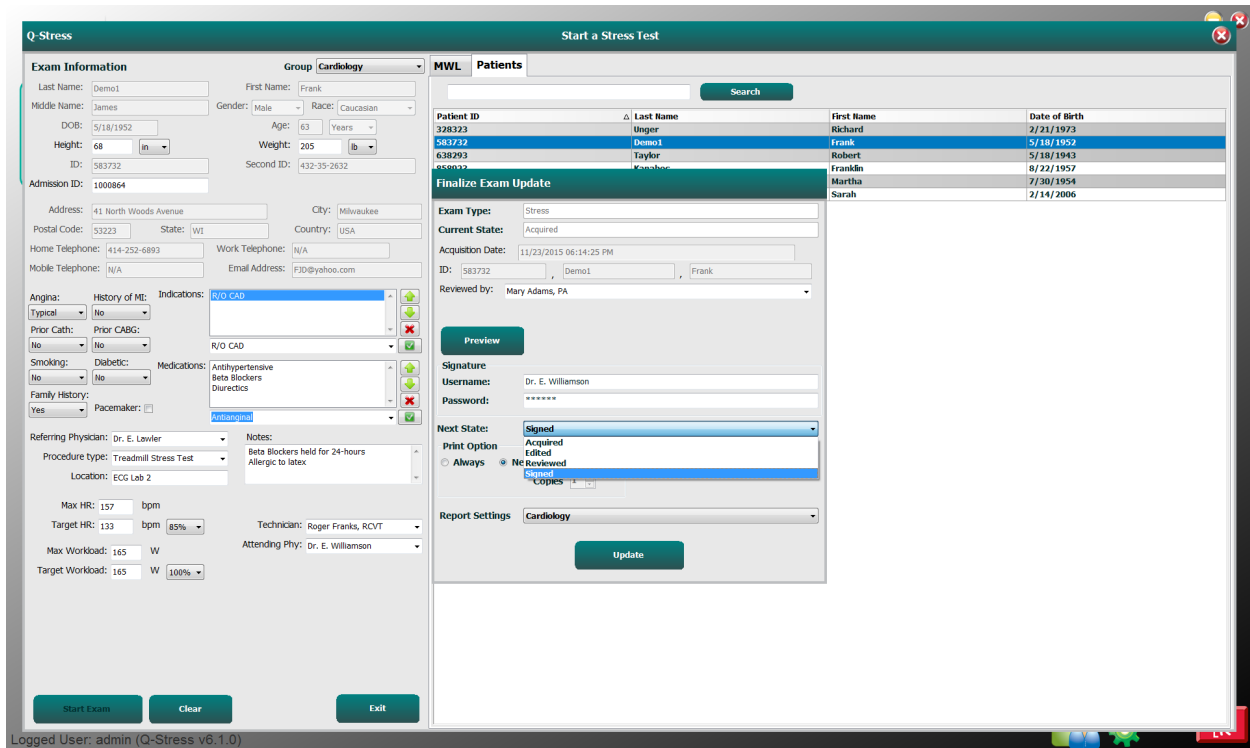

Available Exam Data (applicable to v6.3.1 or >)

If the data acquisition process unexpectedly closes during an exam but before the recovery phase, a warning message will display asking whether to create a report based on recovered data.

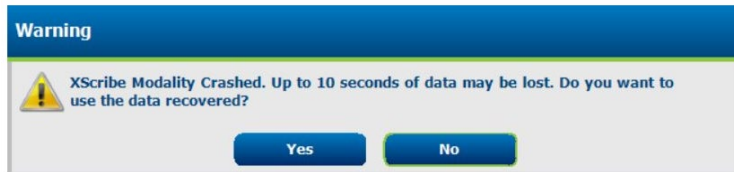

If yes, a report is created with the exam data and is launched in review mode.
If no, temporarily saved exam data is discarded and a new data acquisition is started.

Open Legacy Exams

Open Legacy exams is not currently supported in this software version.

12. SYSTEM AND USER CONFIGURATION

Administration Tasks

The IT and Clinical Administrator user will select the **System Configuration** icon  to enter the Q-Stress administrative functions. All other users can enter this menu to access the Export Service Log task only.

A list of administrative task buttons is presented to:

- Manage user accounts
- Manage personnel lists
- Manage Groups
- Manage archived exams*
- View audit trail logs
- Export service logs for troubleshooting purposes
- Configure system-wide modality settings
- Configure DICOM data exchange**
- Configure (DICOM) MWL Settings**
- Configure XML and PDF file exchange
- Configure display and report format (CFD)
- Configure report settings
- Configure workflow
- Unlock exams

* Task may not be available when operating with DICOM

** Only present when DICOM feature is enabled

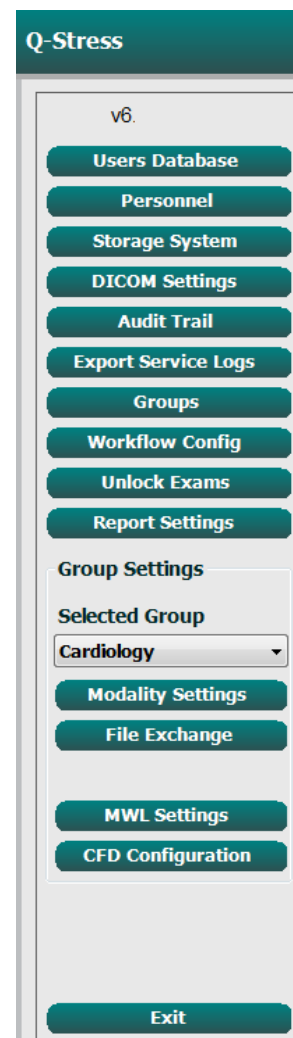

Manage User Accounts and Personnel

User's Database

The IT administrator will select **Users Database** to create new or delete user accounts, reset user passwords, assign roles (permissions) and groups for each user, and assign personnel entries for that user's selection. When active directory is used, no password is needed.

User ID	Username	Name	Roles
1	admin		IT Administrator, Clinical Admin,
2	Physician1	Dr. H. Fuller	Prepare Report, Review and Edit
3	Physician2	Dr. R. Collins	Prepare Report, Review and Edit
4	Physician3	Dr. E. Williamson	Prepare Report, Review and Edit
5	PA1	Mary Adams, PA	Clinical Admin, Schedule Procedure,
6	PA2	John Amos, PA	Clinical Admin, Schedule Procedure,
7	RN1	Selina Garret, RN	Schedule Procedure, Patient
8	RN2	Helen Yates, RN	Schedule Procedure, Patient
9	RN3	Jack Jones, RN	Schedule Procedure, Patient
10	Tech1	Martha Welch, CVT	Schedule Procedure, Patient
11	Tech2	Rober Franks, RCVT	Patient Hookup, Prepare Report,
12	Tech3	Brenda Schultz, RCVT	Patient Hookup, Prepare Report,
13	Tech4	Liz Baker, EMT	Schedule Procedure, Patient

Buttons: New, Edit, Delete

Personnel

Personnel is selected to add personnel that will be available in the Patient Information, Summary, and the Finalize Exam Update windows. Listed personnel can be assigned to each user account and will appear as selections for the logged-in user and in the appropriate final report fields.

Printed Name	Staff ID#	Enabled	In Reviewer List	In Technician List	In Attending Phys List
Dr. H. Fuller	1	<input checked="" type="checkbox"/>	<input checked="" type="checkbox"/>	<input checked="" type="checkbox"/>	<input checked="" type="checkbox"/>
Dr. R. Collins	2	<input checked="" type="checkbox"/>	<input checked="" type="checkbox"/>	<input type="checkbox"/>	<input checked="" type="checkbox"/>
Dr. E. Williamson	3	<input checked="" type="checkbox"/>	<input checked="" type="checkbox"/>	<input type="checkbox"/>	<input checked="" type="checkbox"/>
Mary Adams, PA	4	<input checked="" type="checkbox"/>	<input checked="" type="checkbox"/>	<input checked="" type="checkbox"/>	<input type="checkbox"/>
Selma Garret, RN	5	<input checked="" type="checkbox"/>	<input checked="" type="checkbox"/>	<input checked="" type="checkbox"/>	<input type="checkbox"/>
Martha Welch, CVT	6	<input checked="" type="checkbox"/>	<input type="checkbox"/>	<input checked="" type="checkbox"/>	<input type="checkbox"/>
Roger Franks, RCVT	7	<input checked="" type="checkbox"/>	<input type="checkbox"/>	<input checked="" type="checkbox"/>	<input type="checkbox"/>
John Amos, PA	8	<input checked="" type="checkbox"/>	<input checked="" type="checkbox"/>	<input checked="" type="checkbox"/>	<input type="checkbox"/>
Helen Yates, RN	9	<input checked="" type="checkbox"/>	<input checked="" type="checkbox"/>	<input type="checkbox"/>	<input type="checkbox"/>
Jack Jones, RN	10	<input checked="" type="checkbox"/>	<input type="checkbox"/>	<input type="checkbox"/>	<input type="checkbox"/>
Brenda Schultz, RCVT	11	<input checked="" type="checkbox"/>	<input type="checkbox"/>	<input checked="" type="checkbox"/>	<input type="checkbox"/>
Liz Baker, EMT	12	<input checked="" type="checkbox"/>	<input type="checkbox"/>	<input type="checkbox"/>	<input type="checkbox"/>

New User

Selection of the **New** button within the Users Database window will open the New User dialog, similar to the window to the right.

Tip: It is best to complete the Personnel list before adding Users.

The name entered in the Display Name field will appear on the Q-Stress display when that user logs in.

The login password is entered and repeated.

Roles for this user, Personnel that will populate drop-down lists for this user, and Groups that this user will have access to are checked.

Tip: Refer to [User Role Assignment Table](#).

New User

Username: Rich

Display Name: Richard Blanchard, RCVT

Password: ****

Repeat password: ****

Roles:

- IT Administrator
- Edit Holter Diary
- Clinical Admin
- Edit Conclusions
- Schedule Procedure
- Export Report
- Patient Hookup
- View Exams/Reports
- Prepare Report
- Review and Edit Report
- Sign Report

Personnel:

- Dr. H. Fuller - 1
- Dr. R. Collins - 2
- Dr. E. Williamson - 3
- Mary Adams, PA - 4
- Selma Garret, RN - 5
- Martha Welch, CVT - 6
- Roger Franks, RCVT - 7
- John Amos, PA - 8
- Helen Yates, RN - 9
- Jack Jones, RN - 10
- Brenda Schultz, RCVT - 11
- Liz Baker, EMT - 12

Groups:

- Cardiology
- Radiology
- Chest Pain Ctr
- Children's Clinic

Select All

Select None

OK Cancel

Manage/Create Groups

Groups allow the IT administrator to group exams according to user access, reporting preferences (modality settings) and file exchange preferences. Any user can be assigned to multiple groups. A group definition can be copied and saved with a new name to create a second group, copying all settings and preferences of the existing group.

- Select the **Groups** button to make changes. Any created group can be copied, renamed and modified.
- To create a new group, highlight the group you would like to copy, select **New Group**, and enter the new **Group Name**. A new group will be created with the settings of the highlighted group.
- Select the users under the **Group User List** that may have access to the highlighted group. The **Select All** and **Deselect All** selection can be used to enable or disable all users.
- If you want to rename a group without creating a new one, highlight the group, and enter a Group Name
- Select **Save Group** to save your changes.

The Default group (first in the list) can only be renamed. An unlimited number of new groups can be created and modified.

Q-Stress Modality Settings, DICOM Modality Worklist (MWL), File Exchange paths, Filename customization, and a long, medium, or short format for displayed items and report contents can be uniquely defined for each individual group.

Groups, with exception of the Default group, can be deleted. All exams present in the database for the deleted group will be automatically assigned to the default group.

Modality Settings

Q-Stress modality settings are defined, as default, by the Clinical Administrator user and are available for the user with editing permissions.

The user is able to modify these settings on a per exam basis. Select the tab you wish to modify and click on **Save Changes** or **Discard Changes** to cancel changes before exiting.

Reset to Factory Default can be selected at any time to revert to all of the original setting selections.

Procedures

The Procedures for the factory default group can be modified according to physician and user preferences. A single procedure that contains five tabs, described below and on the following pages, is defined per group.

Real Time Display

Use the drop-down lists to select the **Waveform** speed, gain, **Lead Layout**, **Lead Mode** and 3 or 6 leads for display.

40 Hz, Source Consistency (SCF), and AC filters are enabled by check box.



WARNING: When the 40 Hz filter is used, the frequency response requirement for diagnostic ECG equipment cannot be met. The 40 Hz filter significantly reduces high-frequency components of the ECG and pacemaker spike amplitudes, and is recommended only if high-frequency noise cannot be reduced by proper procedures.

Choose the **Context View** default lead from the drop-down list.

Enable the checkbox for **Running Trends** to display HR, METs, NIBP, and ST during the test.

Standard or **Cabrera** lead mode can be selected.

Enable the zoomed **ST-Lead** by checkbox and use the drop-down list to select the default for the Zoomed ST window. When Dynamic is selected, the lead with the most significant ST change is displayed.

Choose the desired radio button for the **Event Display**.

Printout

Use the drop-down lists to select the ECG Print **Speed**, **Format**, and **Printer Type** for 12-lead ECG printouts. Grid can be enabled for Windows printers. Choose the Rhythm Lead from the drop down and enable Zoom ST Lead and 12 Lead Average for inclusion on printouts as desired.

Arrhythmia Printouts can be enabled/disabled by checkbox. Arrhythmia ECG events will be stored, but will not automatically print when this selection is disabled.

Use the drop-down lists to select the Event Print **Speed**, **Format**, and **Printer Type**. Grid can be enabled for a Windows printer. Choose the Rhythm Lead from the drop down.

Use the drop-down lists to select the Continuous Print **Speed**, **Format**, and **Printer Type** for 3-lead or 6-lead ECG printouts.

Rhythm Events

Use the up/down arrows to select the maximum number of events printed during pre-exercise and PVCs per minute events, maximum couplets per minute, and maximum ventricular runs per minute during exercise.

Use **Add** or **Delete** to modify the Event Labels list.

NOTE: Bookmark, Supine, Mason-Likar, Standing, and Hyperventilation event labels are listed by default and cannot be edited or deleted.

NOTE: Q-Stress automatically detects an arrhythmia event. It is stored, can be displayed on trends display, and automatically printed if Arrhythmia Printouts is enabled.

Configure Drugs

Use **Add** or **Delete** to modify the Drug List and the Dose List.

Items added in this window will be available when a Dose prompt window opens according to protocol, or the Dose button is selected during an exam.

Miscellaneous

Use the drop-down lists to select the **Treadmill Speed Units** and **RPE Scale** type.

Choose Normal or Bold **Z200+ Waveform Print**.

Select checkboxes to enable display and results reporting inclusion of ST/HR Index, Double Product, METS, SpO₂, Duke Score and FAI Score.

Choose drop-down lists to select Male Max HR formula, Female Max HR formula, and ST Units in mm or μ V.

Use up/down arrows or enter a value from 40 to 100 to choose ST post-J measurement in milliseconds.

Display Pre-Exercise will prompt the user with the Advance to Pre-Exercise criteria in the Observation phase when Pre-Exercise button is selected if this checkbox is enabled. When disabled, the user will not be prompted to select Proceed before moving to Pre-Exercise.

Protocols

Users can **Add Protocol** to create a copy of the selected protocol with a name NewProtocol_1 that can be edited and renamed. **Delete Protocol** will delete the selected protocol.

All added protocols and any changes to the factory protocols will be deleted by selection of the **Reset to Factory Default** button.

The Protocols tab selection consists of a list of Protocol Names. Choose from the Protocol Name drop-down list to edit the Pre-Exercise, Exercise, and Recovery phase and stage settings for that protocol. Select the **Save Changes** button prior to exiting, or the **Discard Changes** button to cancel your edits.

Filter List By — Choose the Treadmill or Ergometer radio button for a list of related protocols.

Protocol Name — Use the drop-down list to select a specific protocol. Unit of speed for treadmills is selected using radio buttons.

Pharmacological — A dose setting is included that when selected prompts the system to display a pop-up window notifying the clinician that a next-dose administration may be required.

Add Protocol — Adds an additional protocol requiring the user to complete fields on the 3 tabs: **Pre-Exercise**, **Exercise**, and **Recovery**.

- Type a name for the new protocol
- Select the equipment associated with the new protocol

NOTE: Refer to your treadmill/ergometer documentation to check models supported by Q-Stress, or contact Welch Allyn Technical Support for assistance.

Print Protocol — The selected protocol will be sent to the printer.

Import Protocols — Opens a browser to import protocols from another Q-Stress system.

Export Protocols — Opens a browser to copy this system's protocols to a destination for import at another Q-Stress system.

Pre-Exercise

- Speed/Grade or Power: use the up/down arrows or enter values to define treadmill speed and grade, or ergometer power in watts.

Exercise

- Click **Add Stage** to define the number of exercise stages needed. A maximum of 60 stages at a maximum stage time of 30 minutes per stage and a minimum stage time of 15 seconds per stage may be defined for each protocol.
- Duration, speed, and grade settings are editable at the right of the selected stage.
- ECG printout, BP measurement, and Dose prompt frequencies are defined using the drop-down list.
- Click **Delete Stage** to remove exercise stages.

By Stage

Pre-Exercise Exercise Recovery Print Protocol Import Protocols Export Protocols

Protocol Mode: Stages Time Ramp METs Ramp

Action Type: By Stage Entire Exercise

Add Stage **Delete Stage**

Stage	Duration	Speed	Grade	Print	BP	Dose
Stage 1	3:00	0.0	0.0	End	End	Begin
Stage 2	3:00	0.0	0.0	End	End	Begin
Stage 3	3:00	0.0	0.0	End	End	Begin
Stage 4	3:00	0.0	0.0	End	End	Begin
Stage 5	3:00	0.0	0.0	End	End	Begin
Stage 6	3:00	0.0	0.0	End	End	Begin
Stage 7	3:00	0.0	0.0	End	End	Begin

Duration: 3:00

Speed: 0.0

Grade: 0.0

Print: End

BP: End

Dose: Begin

- Select the **Entire Exercise** radio button to define ECG Print, BP measurement, and Dose starting at mm:ss every mm:ss independent of stage durations.

Entire Exercise

Pre-Exercise Exercise Recovery Print Protocol Import Protocols Export Protocols

Protocol Mode: Stages Time Ramp METs Ramp

Action Type: By Stage Entire Exercise

Add Stage **Delete Stage**

Stage	Duration	Speed	Grade
Stage 1	3:00	0.0	0.0
Stage 2	3:00	0.0	0.0
Stage 3	3:00	0.0	0.0
Stage 4	3:00	0.0	0.0
Stage 5	3:00	0.0	0.0
Stage 6	3:00	0.0	0.0
Stage 7	3:00	0.0	0.0

Duration: 3:00

Speed: 0.0

Grade: 0.0

Print: Off

Start: 2:00

Interval: 2:00

BP: Off

Start: 2:00

Interval: 2:00

Dose: Off

Start: 2:00

Interval: 2:00

- Select the **Time Ramp** radio button to define Speed and Grade at start and end of treadmill exercise; or Watts for ergometer protocols.
- Define the total exam time in minutes and seconds.
- ECG Print and BP measurement intervals are defined starting at mm:ss with mm:ss intervals.

Time Ramp

Pre-Exercise Exercise Recovery Print Protocol Import Protocols Export Protocols

Protocol Mode: Stages Time Ramp METs Ramp

Time Ramp Configuration

Speed at Start of Exercise: 5.0 mph Grade at Start of Exercise: 0.0 %

Speed at End of Exercise: 10.0 mph Grade at End of Exercise: 1.0 %

Total Exam Time: 30:00 mm:ss

Actions

	Start	Interval	
Print:	Off	2:00	2:00 mm:ss
BP:	Off	2:00	2:00 mm:ss
Dose:	Off	2:00	2:00 mm:ss

- Select the **METs Ramp** radio button to define Speed and Grade at start and end of treadmill exercise
- Define the METs threshold value.
- ECG Print and BP measurement intervals are defined starting at mm:ss with mm:ss intervals.

METs Ramp

Pre-Exercise Exercise Recovery Print Protocol Import Protocols Export Protocols

Protocol Mode: Stages Time Ramp METs Ramp

METs Ramp Configuration

Speed at Start of Exercise: 5.0 mph Grade at Start of Exercise: 0.0 %

Rate of Speed Increase: 1.0 mph/min Rate of Grade Increase: 1.0 %/min

METs Threshold Value: 6.0

Actions

	Start	Interval	
Print:	On	2:00	2:00 mm:ss
BP:	On	2:00	2:00 mm:ss
Dose:	Off	2:00	2:00 mm:ss

To define a stage, highlight to display controls for the stage at the right of the selected stage.

- **Time/Speed/Grade or Power:** use the up/down arrows or enter the values to define stage length, and treadmill speed/grade, or ergometer power in watts.
 - set Time in increments of five seconds, starting at 10 seconds.
 - set treadmill speed from 0.0 to 12.0 mph, and 0.0 to 19.3 kph.
 - set treadmill grade from 0° to 25° elevation.
 - set ergometer power starting at 10 watts.
- **ECG Print/BP Measure:** use the drop-down menus to define when to print an ECG and/or prompt for a blood pressure reading.
 - to print/prompt at the beginning of a stage, select **Begin**.
 - to print/prompt at the end of a stage, select **End**.
 - select **Off** for no print/prompt.
 - select **Every** to manually define the print/prompt time. Use the **Start** selection to define when the first ECG Print/BP measure is to occur; use the **Interval** selection to define frequency.
- **Dose:** use the drop-down menu to define when to administer the next pharmacological stage. Settings available are the same as for ECG Print/BP Measure above.

NOTE: When using a device to acquire a BP measurement at the beginning of a stage, Q-Stress will start BP acquisition immediately upon stage start. When acquiring a BP measurement at the end of a stage, Q-Stress will start acquisition one minute before stage end enabling the BP measurement to be included on the ECG printout. If Q-Stress does not receive the BP measurement within the one-minute time period, the BP measurement will not appear on the ECG printout.

Recovery

Start Recovery: Choose the radio button to

- **Automatically begin Recovery at end of Exercise.**
Once the last stage of exercise is completed, the Recovery phase is automatically started.
- **Manually begin Recovery.**
The last stage of exercise will continue until the user selects the Recovery phase.

Recovery Rate: Speed or Watts and time are defined

- Speed at Start of Recovery is defined in mph
- Speed at End of Recovery is defined in mph
- Total Recovery Time duration in minutes and seconds (mm:ss). At completion, Recovery will end and the Report Summary is displayed automatically.

Actions: to occur upon entry into the Recovery phase

- ECG Print, BP measurement, and Dose prompt Start and Interval frequencies are defined in minutes and seconds (mm:ss).

Pre-Exercise	Exercise	Recovery
Start Recovery		
<input checked="" type="radio"/> Automatically begin Recovery at end of Exercise. <input type="radio"/> Manually begin Recovery.		
Recovery Rate		
Speed at Start of Recovery:	0.0	mph
Speed at End of Recovery:	0.0	mph
Total Recovery Time:	6:00	mm:ss
Actions		
	Start	Interval
Print:	On	2:00
BP:	On	2:00
Dose:	Off	2:00

File Exchange

Q-Stress supports the ability to import orders from XML files and export PDF, XML, or both results to an external system dependent on the Q-Stress system activated features. Import/Export directories for the selected group are defined in the File Exchange Configuration window under the File Export Settings tab.

Enter information into the File Information fields to include institution and department information in the exported results.

When Q-Exchange XML is selected as the Export Format, the Q-Exchange version is then selected from a dropdown. Version 3.6 is selected by default.

The Site Number field is not applicable to Q-Stress.

The file name configuration for XML and PDF results may be customized under the Customize Filename tab. To customize, select the **Clear Filename** button, select the tags in the order you wish them to appear in the name, and then **Save Changes**.

To use a common filename for both PDF and XML files, select the **Use Common Filename** checkbox.

NOTE: Default Import/Export paths are defined during software installation. PDF files will be exported to C:\CSImpExp\XmlOutputDir until modified by the administrative user. Access to PDF files are based on user account settings. Permission changes to the file or folder may be required.

NOTE: When exporting results using the Q-Exchange XML report format, the filename must end with **_R**.

NOTE: When DICOM communication is enabled, XML (orders) import selection is grayed to indicate it is not selectable.

File Export Settings

Customize Filename

The screenshot shows the 'File Export Settings' tab of the 'File Exchange Configuration' window. It includes fields for 'Import Directory', 'Export Directory' (C:\CSImpExp\XmlOutputDir), 'User Name', 'Password', and 'Domain'. Under 'Export Format', there are checkboxes for 'Include XML Summary Data on Export', 'Mortara XML', 'Q-Exchange XML' (selected), and 'Include PDF Report Files on Export'. The 'File Information' section has a 'Site Number' field (0), and dropdowns for 'Institution', 'Department', 'Q-Exchange Version' (3.6), 'Q-Exchange Import Locale', and 'Q-Exchange Import Format'. 'Save Changes' and 'Discard Changes' buttons are at the bottom.

The screenshot shows the 'Customize Filename' tab of the 'File Exchange Configuration' window. It has tabs for 'XML Filename' and 'PDF Filename'. A text box shows a filename template: <Mod>^REPORT_EXMGR^<Group>_<PID>^<PLName>^<PFName>^<PMName>_<TY>^<TMonL>^<TDayL>. There are checkboxes for 'Use Common Filename', 'Clear Filename', and 'Restore Default Filename'. A table lists data tags and their corresponding XML tags:

Data	Tag
Patient Demographics	
Patient's ID	<PID>
Patient's Last Name	<PLName>
Patient's First Name	<PFName>
Patient's Middle Name	<PMName>
Patient's Middle Initial	<PMI>
Patient's Sex (Male, Female, Unknown)	<PSexL>
Patient's Sex (M, F, U)	<PSex>
Patient's Prefix	<PPrefix>
Patient's Suffix	<PSuffix>
Patient's DOB Day (Short)	<DOBDay>
Patient's DOB Day (Long)	<DOBDayL>
Patient's DOB Month (Short)	<DOBMonth>
Patient's DOB Month (Long)	<DOBMonthL>
Patient's DOB Year (4 Digit)	<DOBYear>
Exam Information	
Modality (R, X, H)	<Mod>
Group Number	<Group>
Export Type (Auto, manual)	<ExportType>
DICOM Accession Number	<AccessID>
DICOM Admission ID	<AdmisID>
Study Instance UID	<StudyID>
Order ID	<OrderID>

'Save Changes' and 'Discard Changes' buttons are at the bottom.

Refer to [Q-Stress Data Exchange Configuration](#).

CFD Configuration

A long, medium, or short format for displayed items and report contents can be uniquely defined per Group. Select the **CFD Configuration** button to display the Custom Format Definition Name drop-down list. Choose the Long, Intermediate, or Short name for the selected group and then click the **Save** button, or the **Cancel** button to discard your changes.

The **Long** format contains all demographics.

The **Intermediate** format excludes the patient's contact information.

The **Short** format excludes the patient's history, contact information, and the diagnosis section in the report summary.

Long CFD	Intermediate CFD	Short CFD

DICOM and MWL Settings

Q-Stress supports the ability to exchange information with DICOM systems dependent on the system activated features. A DICOM Modality Worklist (MWL) will be received from the DICOM server. A DICOM encapsulated PDF will be exported to the defined destination. Refer to [Q-Stress Data Exchange Configuration](#).

Unlock Exams

Q-Stress internally tracks transitioning exams preventing the same exam to be processed by two or more users. When a second user attempts to access an exam in use, a message displays with notification that the exam is not currently available.

As a measure for recovering locked exams, administrative users can unlock an exam that resides on the same workstation by selecting **Unlock Exams**. Highlight the listed exam(s) and click on **Unlock**.

Manage Archive Storage

The Q-Stress administrative user will manage storage system disks through selection of **Storage System**.

Add Archive Location

Select **New Archive** button to begin definition of a path to the archive directory destination.

- Any external disk (e.g. NAS, USB, etc.) accessible from the Q-Stress central database is a candidate for becoming an archive volume.
- The archive path should be defined as a UNC path such as [\\ServerName\ShareName\Directory\](#)
- A Username, Password and Domain may be entered as needed to add the new storage disk to the Archive drive listing.

Select **Save Changes** button to create the archive location or **Discard Changes** button to exit this window without saving changes.

An archive path may also be deleted by highlighting the desired label and selecting the **Delete Archive** button. When selected, a prompt asking if you are sure you want to delete the selected archive is presented. Select **Yes** or **No**.

Archived exams will remain at the destination until they are manually deleted.

Recover Archived Exams

Administrative users can restore exams from the archive location to the Q-Stress database through selection of **Archive Recovery** tab. Once selected, a window will open allowing a search of the Archive Name or the Archive Label.

To search by Archive Name, a letter or number combination may be entered to show exams that contain the characters. To search by Archive Label, the first letter of the label can be entered with the **Start With** description, or the entire Archive Label can be entered with the **Equal To** description. Select the **Search** button when ready.

The **Clear** button can be selected to clear all search fields. Column headers can be selected to sort listed exams by that item.

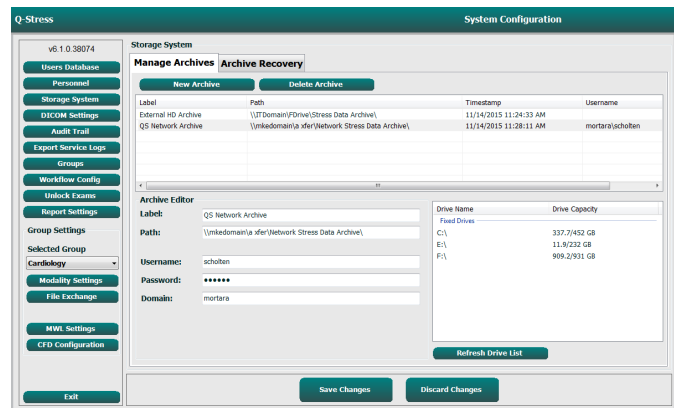

The **Refresh Drive List** button is available to update the list of available drives.

To restore exams, highlight the desired exam(s) in the list and click on **Recover**.

Multiple exams can be restored by highlighting them followed by a single **Recover** button click.

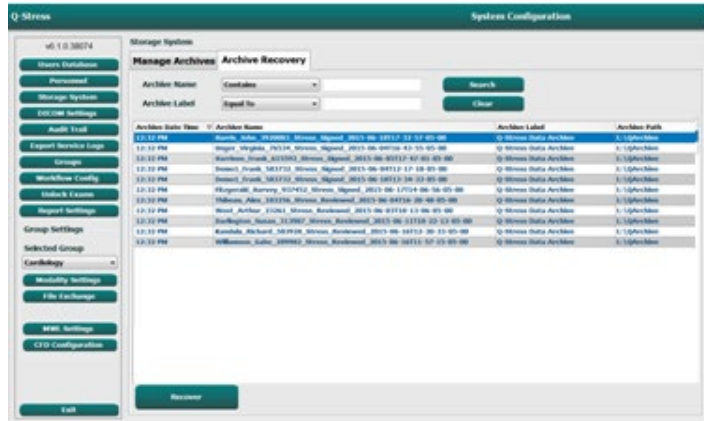

Audit Trail Logs

The Q-Stress administrative user will select **Audit Trail** to view the audit trail history. A selection of filter criteria is available to sort the listing by date, user, workstation, operation, or target (e.g. User, Patient, Exam, Conclusion, Locked Exams, User and System Settings). One or more filter criteria can be used to find audit trails.

Selection of results will display differences by comparing the XML statistics data before and after changes. A legend with colored highlighting will point to added, removed, changed, and moved information.

All configuration information, user information, patient demographic information, exam demographic information, textual conclusions, archive operations, and exam download requests are tracked by the audit trail with a date and time.

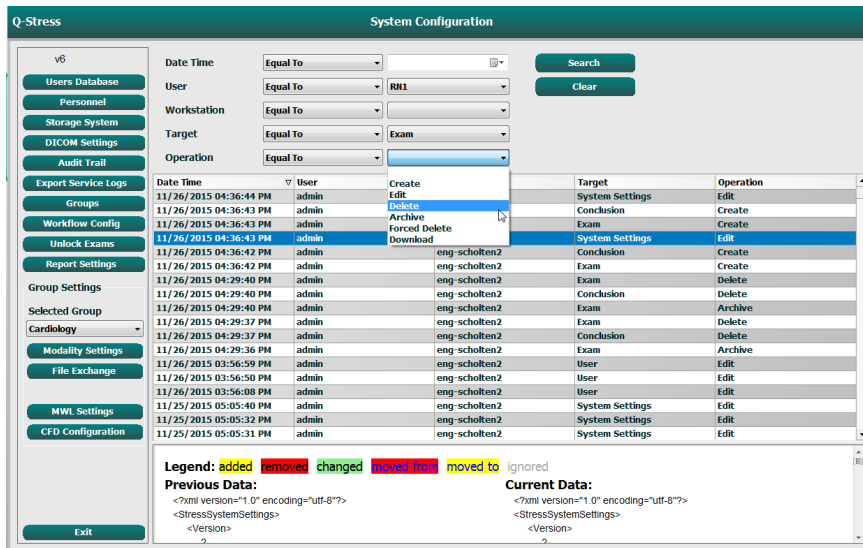

Service Logs

All Q-Stress users have access to **Export Service Logs**. Selection of the button creates a Win-7 zipped file that can be sent to the desktop containing a copy of the system logged events.

The file named EMSysLog.xml.gz can be e-mailed to a Welch Allyn service representative for troubleshooting purposes.

Configure Workflow

The Q-Stress exam states are designed to follow typical user workflow. There are five possibilities with meanings defined below each state:

1. **ORDERED**
The stress exam is either scheduled by a user or an external scheduling system has sent an order.
2. **ACQUIRED**
The stress exam is completed at the Q-Stress system and is ready for editing.
3. **EDITED**
The stress exam has been analyzed with or without changes and is ready for review by a physician. Conclusions may be entered at this state.
4. **REVIEWED**
The stress exam has been reviewed and confirmed to be accurate by an authorized user (e.g. physician, fellow, clinician, etc.). Conclusions may be entered at this state.
5. **SIGNED**
The exam is reviewed and electronically signed by an authorized user. No further workflow processing is required. Conclusions may be entered at this state.

The user with appropriate permissions is prompted with a **Final Exam Update** dialog to confirm or **Update** the next logical state when exiting a stress exam. A drop-down menu allows selection of a state in respect to the exam's current state.

Workflow Config

A Legal Signature can be enabled by selecting **Yes** or disabled by selecting **No**. Administrative users can configure the workflow to include all, or exclude some states through selection of **Workflow Config**.

- Select **All** under Modality Status to enable all five states.
- Select **No REVIEWED** under Modality Status to move the state from EDITED to SIGNED.
- Select **No EDITED/REVIEWED** under Modality Status to move the state from ACQUIRED to SIGNED.

Checkboxes under Export Status allow choices for Manual or Automatic export of the results when the state is updated to Acquired, Edited, Reviewed or Signed. Any combination may be selected.

Workflow Config

Modality Status

All

No REVIEWED

No EDITED/REVIEWED

Export Status

	Manual	Automatic
Acquired:	<input type="checkbox"/>	<input type="checkbox"/>
Edited:	<input type="checkbox"/>	<input type="checkbox"/>
Reviewed:	<input checked="" type="checkbox"/>	<input type="checkbox"/>
Signed:	<input checked="" type="checkbox"/>	<input checked="" type="checkbox"/>

Legal Signature

Yes

No

Save Changes Discard Changes

No Legal Signature

When updating the exam to the signed state, the signature area will show the approver's name with a label of **Approved by:** in the final report.

About the Legal Signature

The legal signature requires the user credentials prior to updating a stress exam when changing to a signed state. When enabled, the user is prompted to authenticate with a user name and password when transitioning to the signed state. Authentication can be entered when a different user is currently logged in. When the correct credentials are not entered, the user will be notified with a message that the "Credentials supplied are not valid."

When the signing physician has been set up as an Attending Physician under Personnel, the printed name will appear in the Q-Stress final report on the signature line following the **Signed by:** field label.

User Preferences

Select the User Preferences icon to open the window. Set selections define the default criteria for the Get Worklist in the Search feature when the particular user is logged into Q-Stress.

Set selections can be changed when the user selects the Advanced search selections.

The user can also change the password in this window if the user account is an internal account.

Q-Stress User Preferences

My Worklist

Default Status Filter: Acquired Edited Reviewed

Default Time Filter (Worklist): All

My Custom Lists

Field name	List Boxes
Dr. J. Smith	<input type="checkbox"/>
Dr. A. White	<input type="checkbox"/>
Dr. T. Ryan	<input type="checkbox"/>

Default

Password

New Password: Repeat Password:

OK Cancel

All users have access to the User Preferences settings but may not have the Search feature available. Those users will only enter this window to change their own password.

There are three possible choices for the Worklist stress exam states that can be enabled or disabled by checkboxes. The choices are dependent on the workflow configuration modality status setting in that Edited or Review may not appear as selections.

1. Acquired
2. Edited
3. Reviewed

There are three choices for the default time filter for worklists.

1. All
2. Today
3. Last week

The user's custom lists can also be modified on this page. Some demographic data entry lists also accept free text which will be automatically added to the list for future use. "My Custom Lists" allows deletion of any list items you do not wish to use in the future.

When finished, select **OK** to save changes or **Cancel** to exit the window without saving changes.

Q-Stress will present the default settings on any of the workstations that the user logs into.

Report Settings

Multiple Q-Stress final reports can be created and saved with user-defined names. These final report choices will be available in a drop-down list when finalizing exams.

Click on the **Report Settings** button. Click the **Add** button to create a new report type.

- Choose the report sections to include using the checkboxes,
- Choose By Stage or By Minute for the Exam Summary and Averages using the radio buttons
- Choose the Averages Format for 3-leads (with leads identified from drop-down lists) or 12-leads using radio buttons
- Use the checkbox to include Arrhythmia Events

Enter the name of the report in the **Print Setting** field. The **Use as Default** check-box may also be selected.

Click on the **Save Changes** button when finished, or **Discard Changes** to cancel without saving.

Click the **Delete** button to remove a report type from the **Print Setting** drop down list when no longer needed.

Once created and saved, the Report Settings list will be available in the Finalize Exam Update dialog when exiting an exam and in the Final Report Print Preview display when the **Preview** button has been selected.

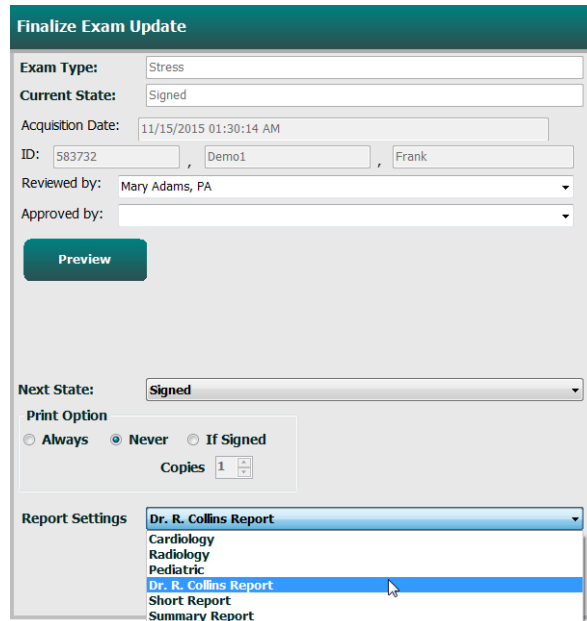
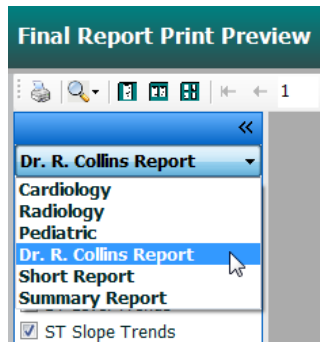

Report Configuration Tool

Q-Stress final reports should be configured with the practice name prior to using the system. The default sections for final report inclusion are also customizable within this tool.

Click on the Q-Stress workstation **Start** menu. Choose **All Programs, Welch Allyn Modality Manager** followed by **Report Configuration Tool** to open a dialog window prompting a **Group** choice from a drop-down list. Each group that has been defined will have its own report configuration.

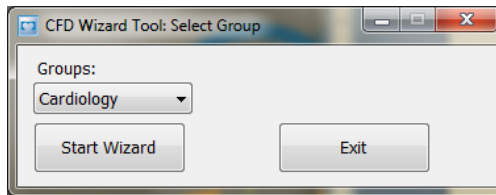
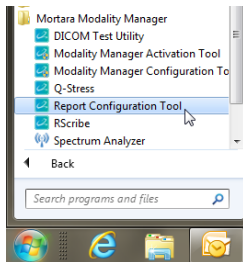

Click on the **Start Wizard** button to open the tool. The **Exit** button will close the tool.

Configuring the Final Report

Once the tool is opened, choose Q-Stress from the report drop-down list.

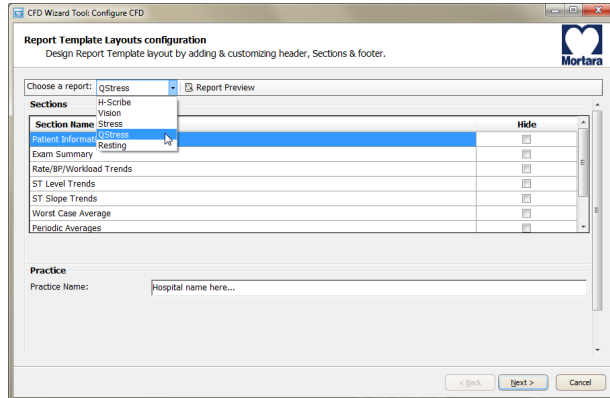

Then, the following can be performed:

1. **Hide** final report sections by checkbox selection in the **Report Configuration Tool**. When the box is checked, the section is disabled as a default; however, the section can be enabled for printing and export when previewing the final report for each individual exam.
2. Enter institution contact information under the **Practice** section.

When finished, click on **Next >** and then **Finish**. **<Back** allows you to return to the previous screen; **Cancel** prompts you with an “Are You Sure” message. Select **Yes** to cancel the changes.

Once finished, the Group selection is still available for you to choose the next group and repeat the steps listed above for all other Groups.

When done, select the **Exit** button.

13. EXAM SEARCH

Exam Search is available for users that will edit, review, print or export reports, archive, delete, copy offline, open offline, and sign stress exams. Click on the icon to open a window allowing you to view a list of the exams according to the filter and your assigned permissions.

The **Get Worklist** button will filter the list of exams according to the User Preferences for the logged in user.

A search field is available for entry of a patient name or ID number. When you enter one or more alphanumeric characters, all exams that start with those characters are displayed in a list when the **Search** button is clicked. Listed exams can be sorted by clicking any of the column headers.

When a complete last name, first name, or patient ID is entered in the search field and the **Search** button is clicked, all matching exams will appear in the list.

Patient ID	Last Name	First Name	Middle	Status	Date/Time	Date of Birth	Group
23861	Scott	Arthur	Richard	Revised	06/01/2015 08:13:06	06/23/1949	Group 1
583732	Demasi	Frank	Alfred	Revised	06/04/2015 17:17:18	05/18/1952	Group 1
583732	Demasi	Frank	Edward	Revised	06/04/2015 15:00:00	05/18/1952	Group 1
718297	Hannan	Paul	August	Revised	06/04/2015 08:11:48	05/22/1955	Group 1
103326	Johnson	Paul	Richard	Revised	06/04/2015 08:30:00	12/29/1949	Group 1
10328	Vogel	Virginia	Alfred	Revised	06/04/2015 08:12:55	02/12/1947	Group 1
583732	Demasi	Frank	Edward	Revised	06/04/2015 08:13:00	05/18/1952	Group 1
583732	Demasi	Frank	Edward	Revised	06/04/2015 08:16:37	05/18/1952	Group 1
583732	Demasi	Frank	Edward	Revised	06/04/2015 12:30:46	05/18/1952	Group 1
415583	Hartman	Frank	Alfred	Revised	06/05/2015 17:47:03	06/30/1966	Group 1
583732	Demasi	Frank	Edward	Revised	06/06/2015 11:36:54	05/18/1952	Group 1
603732	Demasi	Frank	Edward	Revised	06/06/2015 11:07:57	05/18/1952	Group 1
313987	DeRogham	Steven	Richard	Revised	06/11/2015 08:33:13	09/12/1967	Group 1
209803	Williamson	Calvin	Richard	Revised	06/16/2015 11:57:15	06/24/1968	Group 1
583988	Kendall	Richard	Richard	Revised	06/16/2015 12:36:11	02/12/1958	Group 1
718297	Hannan	Paul	August	Revised	06/16/2015 12:54:19	05/22/1955	Group 1
612462	McGinnis	Henry	Alfred	Revised	06/17/2015 04:06:56	06/18/1948	Group 1
583732	Demasi	Frank	Edward	Revised	06/18/2015 11:34:33	05/18/1952	Group 1
583732	Demasi	Frank	Edward	Revised	06/18/2015 08:01:54	05/18/1952	Group 1
209803	Harris	John	Alfred	Revised	06/18/2015 17:12:57	05/01/1955	Group 1

Highlight an exam in the list and then click the

- **Edit** button to open the exam for review and editing, or
- **Report** button to open the final report for review and printing, or
- **More** button to display more advanced selections explained below.



- **Copy Offline** button that allows an existing exam to be copied to an external drive using a browser for review at any Q-Stress v6.x system.
- **Open Offline** button that allows a Q-Stress v6.x system user to open an exam from another v6.x system by browsing to the location of the copied exam.
- **Export** button allows the exam results in PDF, XML, and DICOM format to be sent to a destination defined in the system configuration settings. This is an optional feature and may not be available. This selection is only enabled when the selected exam(s) has the associated export status enabled in the Workflow Config settings.
- **Reconcile** button is typically used to update patient demographics from an order in MWL or a Patient already in the database to an exam that was performed before an order was available.

- **Archive** button is used to move the exam from the database to an external drive for long-term storage purposes. Archive may not be available when DICOM settings are set to prevent it.
- **Delete** button is used to permanently remove an exam or an order from the system database. The exam is not recoverable after performing this action.
- **Open Legacy** button allows legacy X-Scribe version 3.xx archived exams to be opened in the Report Manager display for review and printing.

Advanced Search

For more sophisticated exam list filtering, click on the **Advanced** button. The identifier selections are relational to the selected filter and are dependent on your system configuration.

The exam state(s) are selected by checkbox as identifiers. Click the **Search** button after your filter and identifiers are selected. Click the **Clear** button to cancel and remove your entries from the search fields.

When finished, click the **Done** button to exit the advanced search selections and return to the main Exam Search window.

Patient ID	Last Name	First Name	Status	Date/Time	Date of Birth	Group
583732	Demo1	Frank	Signed	11/23/2015 06:14:25 PM	5/18/1952	Cardiology
583732	Demo1	Frank	Signed	11/14/2015 01:24:37 PM	5/18/1952	Cardiology
583732	Demo1	Frank	Signed	11/15/2015 01:30:14 AM	5/18/1952	Cardiology

Exam State Identifiers

- Acquired
 - Checked if equal to
- Edited
 - Checked if equal to
- Reviewed
 - Checked if equal to
- Signed
 - Checked if equal to

Exam Criteria Identifiers

- Patient ID
 - Equal To
 - Start With
- Last Name
 - Equal To
 - Start With
- First Name
 - Equal To
 - Start With
- Group
 - Equal To
 - Blank (All)
 - Any defined Group this user can access
- Date/Time
 - Equal To
 - Prior To
 - Later Than

14. FINAL REPORTS

The final report can be previewed and printed during stress exam review. Any of the following sections can be excluded by the user with appropriate permissions. This section explains the information contained in each final report page.

Patient Information

The Patient Information header section includes a patient name, patient ID, exam start date/ time, and protocol. Sections below contain patient ID, secondary ID, admission ID, date of birth, age, gender and race; a patient address, telephone and e-mail section; an indication and medications section; a referring physician, procedure type and location section; a target heart rate, reasons for end, technician, and symptoms section; diagnosis, notes and conclusions sections; fields for the reviewer name and the signing physician name with signing date. A report footer with manufacturer name (Welch Allyn, Inc.), the Q-Stress software version, and the institution name are repeated on every page.

The **Diagnosis** field, when present, allows approximately 100 alphanumeric characters. The **Notes** field allows up to approximately 100 alphanumeric characters. The **Reasons for end** field allows up to approximately 55 alphanumeric characters. The **Symptoms** field allows up to approximately 60 alphanumeric characters. The **Conclusions** field allows up to 6 lines of text or approximately 750 alphanumeric characters.

The institution name is customized through use of the Report Configuration Tool.

Exam Summary

The Exam Summary header includes a patient name, patient ID, exam start date/ time, and protocol.

The summary statistics section includes exercise time, leads with 100 μ V change, total number of PVCs during the exam, Duke Treadmill Score and FAI%. The Duke Score and FAI% are only included when a Bruce protocol has been used.

Max Values section includes Speed and Grade or Watts values, METs, HR, SBP, DBP, HR*BP, ST/HR Index, and % Target values.

Max ST Changes lists ST elevation and ST depression change values.

The Stage Summary lists information by stage or by minute for Speed/Grade or Workload (Watts), HR (BPM), BP (mmHg), METs, HR*BP, SpO2 (%), and ST Level (mm) for each period from pre-exercise start through recovery end. Dashes appear in BP and HR*BP columns when no information has been entered. The stage summary will extend to the following page as needed.

The **By Stage** summary table includes:

- Pre-Exercise manual events (supine, standing, hyperventilation and Mason-Likar)
- One entry for the end of each Exercise stage
- One entry for each manual event
- The Peak Exercise ECG
- One entry for the end of the recovery phase
- BP measurements
- Treadmill Events
- Book marks
- RPE Events

The **By Minute** summary table includes:

- Pre-Exercise manual events (supine, standing, hyperventilation and Mason-Likar)
- One entry for every minute of the Exercise phase
- One entry for every minute of the Recovery phase
- One entry for each manual event
- One entry for the end of the recovery phase
- BP measurements
- Treadmill Events
- Book marks
- RPE Events

Rate/BP/Workload Trends

The Rate/BP/Workload page header includes a patient name, patient ID, exam start date/ time, and protocol.

Trends for Heart Rate (BPM), Speed (MPH or KPH)/Grade (%) or Watts, Blood Pressure (mmHg), and METs/Double Product (HR*BP) are included.

ST Level Trends

The ST Level Trends page header includes a patient name, patient ID, exam start date/ time, and protocol. Absolute ST Trends for each of the 12-leads are included.

ST Slope Trends

The ST Slope Trends page header includes a patient name, patient ID, exam start date/ time, and protocol. ST slope trends for each of the 12-leads are included.

Worst Case Average

This section contains a 12-lead set of averages for the start of exercise and a 12-lead set of averages for the maximum ST depression during the exam. Each average displays an ST and ST slope measurement.

The Worst Case 12-lead average presents all 12 simultaneous leads at the worst case moment which is calculated using the maximum ST-depression in any single lead, including aVR inverted.

Ten seconds of rhythm for one lead is preceded by a calibration mark with the rhythm lead that has been selected in the **Modality Settings** printout dialog. The print speed, filter, and gain settings in effect at the end of the exam are used.

The total exercise time is centered in the page header with the worst case ECG time information below it.

Periodic Average

This section contains a set of averages (3-Lead or 12-lead) for the start of exercise and a set for each stage or minute depending on the report settings. A set of averages is also included for the Peak exercise and recovery end.

Peak Average

This section contains a 12-lead set of averages for the start of exercise and a 12-lead set of averages for the end of exercise. Each average displays an ST and ST slope measurement.

Ten seconds of rhythm for one lead is preceded by a calibration mark with the rhythm lead that has been selected in the Modality Settings printout dialog. The print speed, filter, and gain settings in effect at the end of the exam are used.

ECG Prints

The ECG Prints pages include 12-lead ECG pages as they were saved during the exam, added in the Context View, or added during Page Review. ECG Prints include Peak Exercise, Automatic ECGs, and manually initiated printouts (12 Lead Report, Bookmark or other events, RPE events, Averages, and Write Screen).

Beat Consistency Filter (BCF) ECG printouts will include a BCF notification next to the lead label intended to inform the reviewer that the traces are constructed from ECG averages.

The Report Settings icon  allows Arrhythmia Events to be included/excluded, grid printed, and 3-lead or 12-lead ECG averages to be included by stage or by minute. Click **Ok** to change and then the final report is updated and refreshed.

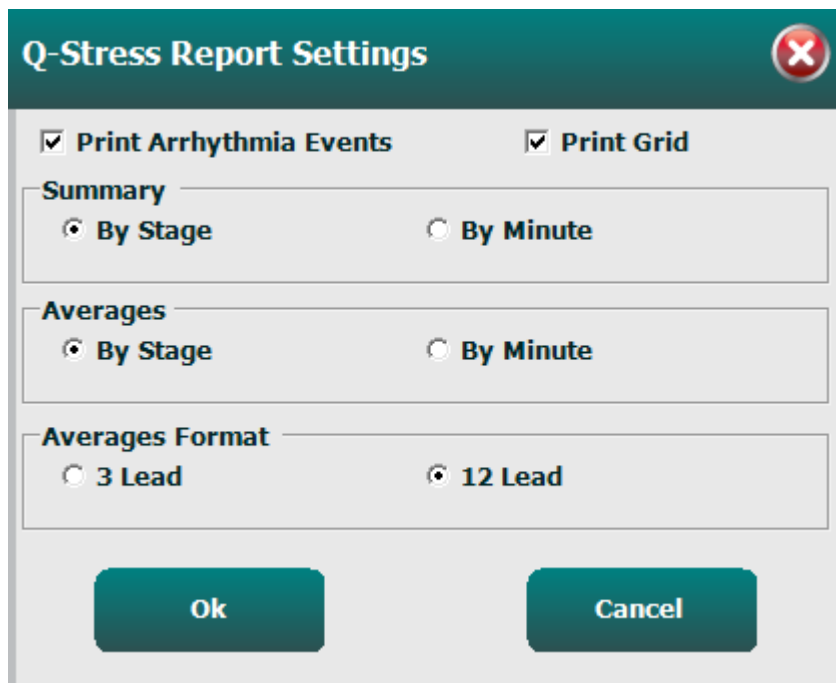

The image shows a dialog box titled "Q-Stress Report Settings" with a close button (X) in the top right corner. The dialog contains several settings:

- Print Arrhythmia Events** and **Print Grid**
- Summary**: **By Stage** and **By Minute**
- Averages**: **By Stage** and **By Minute**
- Averages Format**: **3 Lead** and **12 Lead**

At the bottom of the dialog are two buttons: **Ok** and **Cancel**.

15. MAINTENANCE AND TROUBLESHOOTING

Routine Maintenance Requirements and Cleaning Instructions

1. Use high-pressured air to blow dust or other particles out of the keyboard.
2. Clean keyboard with a damp cloth as necessary.
3. Clean outside of the computer with a soft cloth lightly moistened with a mild detergent solution. Do not use solvents or abrasive cleaners.
4. Clean the display with an industry-standard screen cleaner (these are typically small anti-static towelettes). Do not use solvents or abrasive cleaners. Refer to the instructions that accompany the display.
5. Clean cart with a damp cloth as necessary. A 10% bleach solution is recommended for contaminated areas.

Care and handling of the optional Touch Monitor

1. Disconnect the AC power cable before cleaning
2. Use a clean cloth lightly dampened with mild detergent to clean the display unit cabinet. Do not get liquids on or inside the unit. It is important that the unit remains dry.
3. Clean the touch screen with window or glass cleaner applied to a clean cloth or sponge. Never apply cleaner directly to the touchscreen. Do not use alcohol (methyl, ethyl, or isopropyl), thinner, benzene, or other abrasive cleaners.



Care and handling of the optional antimicrobial keyboard and mouse

The antimicrobial keyboard and mouse are Silver Seal™ protected and contain an antimicrobial agent that inhibits the growth of microbial bacteria, mold, mildew and fungi on the product's surface. A USB Seal Cap™ is included that allows the product to be 100% waterproof and dishwasher safe.

1. These products are dishwasher safe for easy cleaning and may be disinfected with bleach.

Troubleshooting Chart

Screen Message or Issue	Possible Cause	Solution
Baseline drift	Poor skin-to-electrode contact.	Re-prep skin and replace faulty electrode(s). Check impedance using the Observation phase selection with AM12Q front end.
BP Printout and Report discrepancy	Use of BP field to enter new blood pressure values.	BP value entry MUST BE completed through selection of Start BP" when there is an interface to the SunTech Tango BP monitor; or through selection of Enter BP when manually taken. Editing the last BP taken is completed through the selection of the Edit BP button. The Edited value will replace the previously entered value in the report summary.
Square lines displayed on the multi-lead rhythm display screen or on the screen during the exercise test	Lead fail caused by poor skin-to-electrode contact. Broken lead wire/cable.	Correct faulty lead(s) identified in Lead Fail shown in upper right area of the screen. Replace patient cable.
Muscle noise	Electrode placed over muscle or fatty tissue.	Find stable electrode site, re-prep skin, and apply a new electrode.
No response to keyboard commands	Disconnected keyboard cable. Transposed keyboard/mouse cable.	Turn system OFF. Check keyboard to mouse port connections.
Menu cursor will not move	Disconnected mouse cable. Transposed keyboard/mouse cable.	Turn system OFF. Check mouse port connections.
Treadmill does not respond to the ON command from Q-Stress	Equipment powered up in wrong sequence. Treadmill power switch is off, or treadmill cable not properly attached. Emergency stop switch is engaged. Treadmill settings are incorrect. Treadmill USB Drivers have not been installed.	Turn treadmill OFF using menu command. Turn power to the treadmill OFF. Wait one minute and turn power back ON. Proceed with test. Secure the treadmill to Q-Stress cable connectors. Turn treadmill main power switch ON. (Switch is located at the base of the treadmill hood, left side.) Reset emergency stop switch by turning clockwise one-quarter turn. Shutdown and restart Q-Stress. Set Exercise Equipment to proper setting for corresponding treadmill. Refer to Q-Stress System Installation Manual for driver loading instructions.

Screen Message or Issue	Possible Cause	Solution
Z200+ writer paper out, light on	Paper jammed.	Open writer cover and remove jammed paper.
Z200+ writer not printing	No paper in tray. Open writer door.	Insert new packet of paper in tray. See if writer door is latched.
Uneven printing of ECGs or reports	Printer head needs cleaning.	Refer to printer head cleaning instructions in Configure Printer .
Treadmill belt starts to slip	When loose it can shift.	Tighten adjustment bolts on both sides until slippage stops.
Lead Fail message without any square waves in place of ECG for all 12-leads when all leads are connected to the patient. RA/LA/LL/V1/V2/V3/V4/V5/V6 or C1/C2/C3/C4/C5/C6 FAIL	The Front-End device is not correctly connected. Incorrect Trigger Module selection The Front-End device drivers are not installed.	Disconnect the USB cable from the PC. Reconnect the USB cable to the PC. The system emits a confirmation beep. 1) Check the Q-Stress front end (AM12Q) USB connection to the Trigger Module USB port. a. Is it ECG A or ECG B? 2) Select Local settings in the Observation phase. 3) Select the proper selection under Trigger Module in the Local Settings dialog, and then select OK. Refer to Q-Stress System Installation Manual for driver loading instructions.
No Exams are Currently Selected	An attempt to access a final report but no patient is selected from the Search Exam list.	Click on the patient name to select and access the file.
A warning symbol appears on the screen next to ST measurements.	The measurement points (J-point, Isoelectric point, or J+ XX msec) have been modified by the user during or after the stress test.	Warning symbol indicates that a manual change occurred and that the results are now based on new user determinations.
RA/LA/LL/V1/V2/V3/V4/V5/V6 or C1/C2/C3/C4/C5/C6 FAIL with square waves for all 12-leads.	One or more leads are in fail.	Reprep lead sites and replace the electrodes. If not resolved, replace patient cable.
No Network or LAN communication	RJ45 plug connected to the wrong RJ45 slot.	Disconnect the RJ45 plug from the back of the PC and connect it to the other RJ45 slot.
No or unreliable TTL or Analog output signals	Bad connection or cable Use of lead with noise, low amplitude QRS or high amplitude T-waves	Check connection between the Trigger Module and Tango or Echo device Select a more appropriate Synch lead for the TTL and analog output in the Format Settings/F1 menu.

System Information Log

The following system information log is provided for your convenience. You will need this information if the system needs servicing. Update the log when you add options or your system has been serviced.

NOTE: *It is strongly recommended that you make a copy of this log and file it after you enter the information.*

Record the model and serial number of all components, dates of removal, and/or replacement of components, and the name of the vendor from whom the component was purchased and/or installed.

In addition to having records of this information, the system information provides a record of when your system was placed in service.

Manufacturer:

Welch Allyn, Inc.
4341 State Street Road
Skaneateles Falls, NY 13153

Telephone Numbers:

Domestic: 800-231-7437
Sales Department: 800-231-7437
Service Department: 888-667-8272

Product Information:

Name of Unit/Product: Q-Stress

Date of Purchase: _____ / _____ / _____

Purchased Unit From: _____

Serial Number _____

Software Version: _____

For questions or service information when calling into Welch Allyn Technical Support, have the system serial number and the reference number available. The serial number and part number (REF) are printed on the Product Identification Card (9517-006-01-ENG) delivered with the system software.

16. PROTOCOLS

The following 16 protocols are delivered with every Q-Stress system.

Treadmill:

- Bruce
- Modified Bruce
- Naughton
- Balke
- Ellestad
- USAF/SAM 2.0
- USAF/SAM 3.3
- High Ramp (Stage Protocol)
- Medium Ramp (Stage Protocol)
- Low Ramp (Stage Protocol)
- Treadmill Time Ramp
- Treadmill METs Ramp
- Pharmacological

Ergometer:

- Astrand
- Cycle
- Cycle Time Ramp

These protocols produce the following operations and conditions:

- Automatic workload according to the programmed protocol.
- Automatic BP acquisition according to user-defined times.
- Automatic ECG generation according to user-defined times.
- In the Recovery phase, user-selection to automatically begin at exercise end or manually begin Recovery.
- In the Recovery phase, the treadmill speed or ergometer Watts can be ramped down when a different start and end workload has been programmed. Change will gradually occur according to the Recovery duration.

***NOTE:** Protocols are subject to physician preference and may be modified as desired. Refer to [System and User Configuration](#) for protocol editing instructions.*

Stage Protocols

Stage protocols are a collection of stage durations, treadmill speed and grade or Watts loads for each stage, and actions such as ECG prints and BP measurements. Progression to the next stage causes a stepped change in workload.

Linear Ramp Protocols

The Time Ramp and METs Ramp protocols will increase the speed and elevation of the treadmill, or Watts load for the ergometer, gradually over the period of the exercise defined by an end time or METs threshold instead of a rapid

change at the start of each new stage. There is a single exercise stage for ramped protocols. The progression of exercise is linear rather than stepped.

Bruce Protocols

The sample Bruce protocol produces the following operations and conditions:

- A stage change occurs every 3 minutes with an increase in treadmill speed and grade.
- An automatic blood pressure measurement is initiated one minute before the end of each stage.
- A 12-lead ECG report is automatically generated at the end of each 3-minute stage. ECG acquisition begins 12 seconds prior to the end of a stage.
- In the Recovery phase, the treadmill slows to 1.5 mph and continues for a duration of 6-minutes.
 - A Peak Exercise 12-Lead ECG prints immediately and automatically
- Actions:
 - Recovery ECG prints are Off.
 - Recovery BP measurement intervals are Off.

STAGE PROTOCOL: BRUCE

Bruce

General Information			
Protocol Mode:	Stages	Pharmacological:	No
Equipment Type:	Treadmill	Speed Units:	Miles Per Hour

Pre-Exercise			
Procedure			
Speed:	1.0 mph	Grade:	0.0 %

Exercise					
Stage:	Duration:	Speed:	Grade:	Print:	BP:
Stage 1	3:00 min	1.7 mph	10.0 %	End	End
Stage 2	3:00 min	2.5 mph	12.0 %	End	End
Stage 3	3:00 min	3.4 mph	14.0 %	End	End
Stage 4	3:00 min	4.2 mph	16.0 %	End	End
Stage 5	3:00 min	5.0 mph	18.0 %	End	End
Stage 6	3:00 min	5.5 mph	20.0 %	End	End
Stage 7	3:00 min	6.0 mph	22.0 %	End	End

Recovery			
Procedure			
Speed Start:	1.5 mph	Duration:	6:00 min
Speed End:	1.5 mph	Enter Recovery:	Automatically

STAGE PROTOCOL: MODIFIED BRUCE

Modified Bruce

General Information			
Protocol Mode:	Stages	Pharmacological:	No
Equipment Type:	Treadmill	Speed Units:	Miles Per Hour

Pre-Exercise			
Procedure			
Speed:	0.8 mph	Grade:	0.0 %

Exercise					
Stage:	Duration:	Speed:	Grade:	Print:	BP:
Stage 1	3:00 min	1.7 mph	0.0 %	End	Begin
Stage 2	3:00 min	1.7 mph	5.0 %	End	Begin
Stage 3	3:00 min	1.7 mph	10.0 %	End	Begin
Stage 4	3:00 min	2.5 mph	12.0 %	End	Begin
Stage 5	3:00 min	3.4 mph	14.0 %	End	Begin
Stage 6	3:00 min	4.2 mph	16.0 %	End	Begin
Stage 7	3:00 min	5.0 mph	18.0 %	End	Begin
Stage 8	3:00 min	5.5 mph	20.0 %	End	Begin
Stage 9	3:00 min	6.0 mph	22.0 %	End	Begin

Recovery			
Procedure			
Speed Start:	1.0 mph	Duration:	6:00 min
Speed End:	1.0 mph	Enter Recovery:	Automatically

STAGE PROTOCOL: NAUGHTON

Naughton

General Information			
Protocol Mode:	Stages	Pharmacological:	No
Equipment Type:	Treadmill	Speed Units:	Miles Per Hour

Pre-Exercise			
Procedure			
Speed:	0.8 mph	Grade:	0.0 %

Exercise					
Stage:	Duration:	Speed:	Grade:	Print:	BP:
Stage 1	2:00 min	1.0 mph	0.0 %	End	Off
Stage 2	2:00 min	2.0 mph	2.0 %	End	End
Stage 3	2:00 min	2.0 mph	3.5 %	End	Off
Stage 4	2:00 min	2.0 mph	7.0 %	End	End
Stage 5	2:00 min	2.0 mph	10.5 %	End	Off
Stage 6	2:00 min	2.0 mph	14.0 %	End	End
Stage 7	2:00 min	2.0 mph	17.5 %	End	Off

Recovery			
Procedure			
Speed Start:	1.0 mph	Duration:	6:00 min
Speed End:	1.0 mph	Enter Recovery:	Automatically

STAGE PROTOCOL: BALKE

Balke

General Information			
Protocol Mode:	Stages	Pharmacological:	No
Equipment Type:	Treadmill	Speed Units:	Miles Per Hour

Pre-Exercise			
Procedure			
Speed:	1.0 mph	Grade:	0.0 %

Exercise					
Stage:	Duration:	Speed:	Grade:	Print:	BP:
Stage 1	1:00 min	3.3 mph	1.0 %	End	Off
Stage 2	1:00 min	3.3 mph	2.0 %	End	Off
Stage 3	1:00 min	3.3 mph	3.0 %	End	End
Stage 4	1:00 min	3.3 mph	4.0 %	End	Off
Stage 5	1:00 min	3.3 mph	5.0 %	Off	Off
Stage 6	1:00 min	3.3 mph	6.0 %	End	End
Stage 7	1:00 min	3.3 mph	7.0 %	End	Off
Stage 8	1:00 min	3.3 mph	8.0 %	End	Off
Stage 9	1:00 min	3.3 mph	9.0 %	End	End
Stage 10	1:00 min	3.3 mph	10.0 %	End	Off
Stage 11	1:00 min	3.3 mph	11.0 %	End	Off
Stage 12	1:00 min	3.3 mph	12.0 %	End	End
Stage 13	1:00 min	3.3 mph	13.0 %	End	Off
Stage 14	1:00 min	3.3 mph	14.0 %	End	Off
Stage 15	1:00 min	3.3 mph	15.0 %	End	End
Stage 16	1:00 min	3.3 mph	16.0 %	End	Off
Stage 17	1:00 min	3.3 mph	18.0 %	End	Off
Stage 18	1:00 min	3.3 mph	20.0 %	End	End
Stage 19	1:00 min	3.3 mph	21.0 %	End	Off
Stage 20	1:00 min	3.3 mph	22.0 %	End	Off
Stage 21	1:00 min	3.3 mph	23.0 %	End	End
Stage 22	1:00 min	3.3 mph	24.0 %	End	Off

Recovery			
Procedure			
Speed Start:	1.0 mph	Duration:	6:00 min
Speed End:	1.0 mph	Enter Recovery:	Automatically

STAGE PROTOCOL: ELLESTAD**Ellestad**

General Information			
Protocol Mode:	Stages	Pharmacological:	No
Equipment Type:	Treadmill	Speed Units:	Miles Per Hour

Pre-Exercise			
Procedure			
Speed:	1.0 mph	Grade:	0.0 %

Exercise					
Stage:	Duration:	Speed:	Grade:	Print:	BP:
Stage 1	3:00 min	1.7 mph	10.0 %	End	End
Stage 2	3:00 min	3.0 mph	10.0 %	End	End
Stage 3	3:00 min	4.0 mph	10.0 %	End	End
Stage 4	3:00 min	5.0 mph	10.0 %	End	End
Stage 5	3:00 min	6.0 mph	15.0 %	End	End
Stage 6	3:00 min	7.0 mph	15.0 %	End	End
Stage 7	3:00 min	8.0 mph	15.0 %	End	End

Recovery			
Procedure			
Speed Start:	1.5 mph	Duration:	6:00 min
Speed End:	1.5 mph	Enter Recovery:	Automatically

STAGE PROTOCOL: USAF/SAM 2.0**USAF/SAM 2.0**

General Information			
Protocol Mode:	Stages	Pharmacological:	No
Equipment Type:	Treadmill	Speed Units:	Miles Per Hour

Pre-Exercise			
Procedure			
Speed:	0.8 mph	Grade:	0.0 %

Exercise					
Stage:	Duration:	Speed:	Grade:	Print:	BP:
Stage 1	3:00 min	2.0 mph	0.0 %	End	Off
Stage 2	3:00 min	2.0 mph	5.0 %	End	End
Stage 3	3:00 min	2.0 mph	10.0 %	End	Off
Stage 4	3:00 min	2.0 mph	15.0 %	End	End
Stage 5	3:00 min	2.0 mph	20.0 %	End	Off
Stage 6	3:00 min	2.0 mph	25.0 %	End	End

Recovery			
Procedure			
Speed Start:	1.0 mph	Duration:	6:00 min
Speed End:	1.0 mph	Enter Recovery:	Automatically

STAGE PROTOCOL: USAF/SAM 3.3**USAF/SAM 3.3**

General Information			
Protocol Mode:	Stages	Pharmacological:	No
Equipment Type:	Treadmill	Speed Units:	Miles Per Hour

Pre-Exercise			
Procedure			
Speed:	1.2 mph	Grade:	0.0 %

Exercise					
Stage:	Duration:	Speed:	Grade:	Print:	BP:
Stage 1	3:00 min	3.3 mph	0.0 %	End	Off
Stage 2	3:00 min	3.3 mph	5.0 %	End	End
Stage 3	3:00 min	3.3 mph	10.0 %	End	Off
Stage 4	3:00 min	3.3 mph	15.0 %	End	End
Stage 5	3:00 min	3.3 mph	20.0 %	End	Off
Stage 6	3:00 min	3.3 mph	25.0 %	End	End

Recovery			
Procedure			
Speed Start:	1.2 mph	Duration:	6:00 min
Speed End:	1.2 mph	Enter Recovery:	Automatically

STAGE PROTOCOL: HIGH RAMP**High Ramp**

General Information			
Protocol Mode:	Stages	Pharmacological:	No
Equipment Type:	Treadmill	Speed Units:	Miles Per Hour

Pre-Exercise			
Procedure			
Speed:	1.0 mph	Grade:	0.0 %

Exercise					
Stage:	Duration:	Speed:	Grade:	Print:	BP:
Stage 1	0:30 min	1.6 mph	5.0 %	End	End
Stage 2	0:30 min	1.7 mph	10.0 %	End	End
Stage 3	0:30 min	1.7 mph	10.0 %	End	End
Stage 4	0:30 min	2.0 mph	10.0 %	End	End
Stage 5	1:00 min	2.2 mph	11.0 %	End	End
Stage 6	0:30 min	2.4 mph	11.5 %	End	End
Stage 7	0:30 min	2.5 mph	12.0 %	End	End
Stage 8	0:30 min	2.6 mph	12.5 %	End	End
Stage 9	0:30 min	2.8 mph	13.0 %	End	End
Stage 10	1:00 min	3.0 mph	13.5 %	End	End
Stage 11	0:30 min	3.2 mph	14.0 %	End	End
Stage 12	0:30 min	3.4 mph	14.0 %	End	End
Stage 13	0:30 min	3.5 mph	14.5 %	End	End
Stage 14	0:30 min	3.6 mph	15.0 %	End	End
Stage 15	1:00 min	3.7 mph	15.5 %	End	End
Stage 16	0:40 min	4.0 mph	16.0 %	End	End
Stage 17	0:40 min	4.2 mph	16.0 %	End	End
Stage 18	0:40 min	4.4 mph	16.5 %	End	End
Stage 19	0:40 min	4.6 mph	17.0 %	End	End
Stage 20	0:40 min	4.8 mph	17.5 %	End	End
Stage 21	0:40 min	5.0 mph	18.0 %	End	End
Stage 22	0:40 min	5.2 mph	19.0 %	End	End
Stage 23	0:40 min	5.5 mph	20.0 %	End	End
Stage 24	0:40 min	5.8 mph	21.0 %	End	End
Stage 25	0:40 min	6.0 mph	22.0 %	End	End

Recovery			
Procedure			
Speed Start:	1.0 mph	Duration:	6:00 min
Speed End:	1.0 mph	Enter Recovery:	Automatically

STAGE PROTOCOL: MEDIUM RAMP

Medium Ramp

General Information			
Protocol Mode:	Stages	Pharmacological:	No
Equipment Type:	Treadmill	Speed Units:	Miles Per Hour

Pre-Exercise			
Procedure			
Speed:	1.0 mph	Grade:	0.0 %

Exercise					
Stage:	Duration:	Speed:	Grade:	Print:	BP:
Stage 1	0:30 min	1.5 mph	3.0 %	End	End
Stage 2	0:30 min	1.6 mph	4.0 %	End	End
Stage 3	0:30 min	1.7 mph	5.0 %	End	End
Stage 4	0:30 min	1.7 mph	6.0 %	End	End
Stage 5	1:00 min	1.8 mph	7.0 %	End	End
Stage 6	0:30 min	1.9 mph	8.0 %	End	End
Stage 7	0:30 min	2.0 mph	8.5 %	End	End
Stage 8	0:30 min	2.1 mph	9.0 %	End	End
Stage 9	0:30 min	2.2 mph	9.5 %	End	End
Stage 10	1:00 min	2.3 mph	10.0 %	End	End
Stage 11	0:30 min	2.4 mph	11.0 %	End	End
Stage 12	0:30 min	2.5 mph	11.5 %	End	End
Stage 13	0:30 min	2.6 mph	12.0 %	End	End
Stage 14	0:30 min	2.7 mph	12.5 %	End	End
Stage 15	1:00 min	2.8 mph	13.0 %	End	End
Stage 16	0:40 min	3.0 mph	13.5 %	End	End
Stage 17	0:40 min	3.2 mph	14.0 %	End	End
Stage 18	0:40 min	3.4 mph	14.5 %	End	End
Stage 19	0:40 min	3.6 mph	15.0 %	End	End
Stage 20	0:40 min	3.8 mph	15.5 %	End	End
Stage 21	0:40 min	4.0 mph	16.0 %	End	End
Stage 22	0:40 min	4.2 mph	17.0 %	End	End
Stage 23	0:40 min	4.5 mph	18.0 %	End	End
Stage 24	0:40 min	4.8 mph	19.0 %	End	End
Stage 25	0:40 min	5.2 mph	20.0 %	End	End

Recovery			
Procedure			
Speed Start:	1.0 mph	Duration:	6:00 min
Speed End:	1.0 mph	Enter Recovery:	Automatically
Actions			
Print Start:	1:00 min	Print Interval:	2:00 min
BP Start:	1:40 min	BP Interval:	2:00 min

STAGE PROTOCOL: LOW RAMP**Low Ramp**

General Information			
Protocol Mode:	Stages	Pharmacological:	No
Equipment Type:	Treadmill	Speed Units:	Miles Per Hour

Pre-Exercise			
Procedure			
Speed:	1.0 mph	Grade:	0.0 %

Exercise					
Stage:	Duration:	Speed:	Grade:	Print:	BP:
Stage 1	0:30 min	1.0 mph	0.0 %	End	End
Stage 2	0:30 min	1.1 mph	1.0 %	End	End
Stage 3	0:30 min	1.2 mph	1.0 %	End	End
Stage 4	0:30 min	1.3 mph	2.0 %	End	End
Stage 5	1:00 min	1.4 mph	3.0 %	End	End
Stage 6	0:30 min	1.5 mph	4.0 %	End	End
Stage 7	0:30 min	1.6 mph	4.0 %	End	End
Stage 8	0:30 min	1.7 mph	5.0 %	End	End
Stage 9	0:30 min	1.8 mph	6.0 %	End	End
Stage 10	1:00 min	1.9 mph	7.0 %	End	End
Stage 11	0:30 min	2.0 mph	8.0 %	End	End
Stage 12	0:30 min	2.1 mph	8.5 %	End	End
Stage 13	0:30 min	2.2 mph	9.0 %	End	End
Stage 14	0:30 min	2.3 mph	9.5 %	End	End
Stage 15	1:00 min	2.4 mph	10.0 %	End	End
Stage 16	0:30 min	2.5 mph	10.5 %	End	End
Stage 17	0:30 min	2.6 mph	11.0 %	End	End
Stage 18	1:00 min	2.7 mph	12.0 %	End	End
Stage 19	0:30 min	2.8 mph	13.0 %	End	End
Stage 20	0:30 min	2.9 mph	14.0 %	End	End
Stage 21	1:00 min	3.0 mph	15.0 %	End	End
Stage 22	0:30 min	3.1 mph	16.0 %	End	End
Stage 23	0:30 min	3.2 mph	17.0 %	End	End
Stage 24	1:00 min	3.4 mph	18.0 %	End	End
Stage 25	1:00 min	3.6 mph	19.0 %	End	End

Recovery			
Procedure			
Speed Start:	1.5 mph	Duration:	6:00 min
Speed End:	1.5 mph	Enter Recovery:	Automatically

STAGE PROTOCOL: PHARMACOLOGICAL

Pharmacological

General Information			
Protocol Mode:	Stages	Pharmacological:	Yes
Equipment Type:	Treadmill	Speed Units:	Miles Per Hour

Pre-Exercise			
Procedure			
Speed:	0.0 mph	Grade:	0.0 %

Exercise						
Stage:	Duration:	Speed:	Grade:	Print:	BP:	Dose:
Stage 1	3:00 min	0.0 mph	0.0 %	End	End	Begin
Stage 2	3:00 min	0.0 mph	0.0 %	End	End	Begin
Stage 3	3:00 min	0.0 mph	0.0 %	End	End	Begin
Stage 4	3:00 min	0.0 mph	0.0 %	End	End	Begin
Stage 5	3:00 min	0.0 mph	0.0 %	End	End	Begin
Stage 6	3:00 min	0.0 mph	0.0 %	End	End	Begin
Stage 7	3:00 min	0.0 mph	0.0 %	End	End	Begin

Recovery			
Procedure			
Speed Start:	0.0 mph	Duration:	6:00 min
Speed End:	0.0 mph	Enter Recovery:	Automatically

RAMP PROTOCOL: TREADMILL TIME RAMP**Treadmill Time Ramp**

General Information			
Protocol Mode:	Time Ramp	Pharmacological:	No
Equipment Type:	Treadmill	Speed Units:	Miles Per Hour

Pre-Exercise			
Procedure			
Speed:	1.0 mph	Grade:	0.0 %

Exercise			
Procedure			
Speed Start:	1.7 mph	Grade Start:	10.0 %
Speed End:	6.0 mph	Grade End:	22.0 %
Duration:	21:00 min		
Actions			
Print Start:	3:00 min	Print Interval:	3:00 min
BP Start:	2:00 min	BP Interval:	3:00 min

Recovery			
Procedure			
Speed Start:	1.0 mph	Duration:	6:00 min
Speed End:	1.0 mph	Enter Recovery:	Automatically
Actions			
Print Start:	1:00 min	Print Interval:	2:00 min
BP Start:	2:00 min	BP Interval:	3:00 min

RAMP PROTOCOL: TREADMILL METS RAMP

Treadmill Mets Ramp

General Information			
Protocol Mode:	METs Ramp	Pharmacological:	No
Equipment Type:	Treadmill	Speed Units:	Miles Per Hour

Pre-Exercise			
Procedure			
Speed:	1.0 mph	Grade:	0.0 %

Exercise			
Procedure			
Speed Start:	1.7 mph	Grade Start:	10.0 %
Speed Rate:	0.8 mph/min	Grade Rate:	2.0 %/min
METs Threshold:	12.0		
Actions			
Print Start:	3:00 min	Print Interval:	3:00 min
BP Start:	2:00 min	BP Interval:	3:00 min

Recovery			
Procedure			
Speed Start:	1.0 mph	Duration:	6:00 min
Speed End:	1.0 mph	Enter Recovery:	Automatically
Actions			
Print Start:	1:00 min	Print Interval:	2:00 min
BP Start:	2:00 min	BP Interval:	3:00 min

STAGE PROTOCOL: ASTRAND (ERGOMETER)

Astrand

General Information			
Protocol Mode:	Stages	Pharmacological:	No
Equipment Type:	Ergometer	Speed Units:	N/A

Pre-Exercise	
Procedure	
Watts:	50 Watts

Exercise				
Stage:	Duration:	Watts:	Print:	BP:
Stage 1	6:00 min	50 Watts	End	End
Stage 2	6:00 min	100 Watts	End	End
Stage 3	6:00 min	150 Watts	End	End
Stage 4	6:00 min	200 Watts	End	End
Stage 5	6:00 min	250 Watts	End	End
Stage 6	6:00 min	300 Watts	End	End

Recovery			
Procedure			
Watts Start:	50 Watts	Duration:	6:00 min
Watts End:	50 Watts	Enter Recovery:	Automatically

STAGE PROTOCOL: CYCLE (ERGOMETER)

Cycle

General Information			
Protocol Mode:	Stages	Pharmacological:	No
Equipment Type:	Ergometer	Speed Units:	N/A

Pre-Exercise	
Procedure	
Watts:	10 Watts

Exercise				
Stage:	Duration:	Watts:	Print:	BP:
Stage 1	3:00 min	25 Watts	Begin	End
Stage 2	3:00 min	50 Watts	Begin	End
Stage 3	3:00 min	75 Watts	Begin	End
Stage 4	3:00 min	100 Watts	Begin	End
Stage 5	3:00 min	125 Watts	Begin	End
Stage 6	3:00 min	150 Watts	Begin	End
Stage 7	3:00 min	175 Watts	Begin	End
Stage 8	3:00 min	200 Watts	Begin	End
Stage 9	3:00 min	225 Watts	Begin	End
Stage 10	3:00 min	250 Watts	Begin	End

Recovery			
Procedure			
Watts Start:	25 Watts	Duration:	6:00 min
Watts End:	25 Watts	Enter Recovery:	Automatically

RAMP PROTOCOL: CYCLE TIME RAMP (ERGOMETER)

Cycle Time Ramp

General Information			
Protocol Mode:	Time Ramp	Pharmacological:	No
Equipment Type:	Ergometer	Speed Units:	N/A
Pre-Exercise			
Procedure			
Watts:	10 Watts		
Exercise			
Procedure			
Watts Start:	10 Watts		
Watts End:	125 Watts		
Duration:	15:00 min		
Recovery			
Procedure			
Watts Start:	25 Watts	Duration:	6:00 min
Watts End:	25 Watts	Enter Recovery:	Automatically
Actions			
Print Start:	1:00 min	Print Interval:	2:00 min

17. TTL/ANALOG OUTPUT

Q-Stress supports the capability of interfacing to a cardiac ultrasound (Echo) imaging system. This feature is accomplished with an optional TTL (transistor, transistor, logic) or analog output.



WARNING: Equipment connected via the TTL or analog cable must be IEC 60601-1 compliant.

TTL Output

The signal complies with the TTL standards and can be derived from any of the 12 leads. The Echo captures images of ventricular systole and diastole based on R-wave gating.

Sample Representation of R-wave Pulse Output

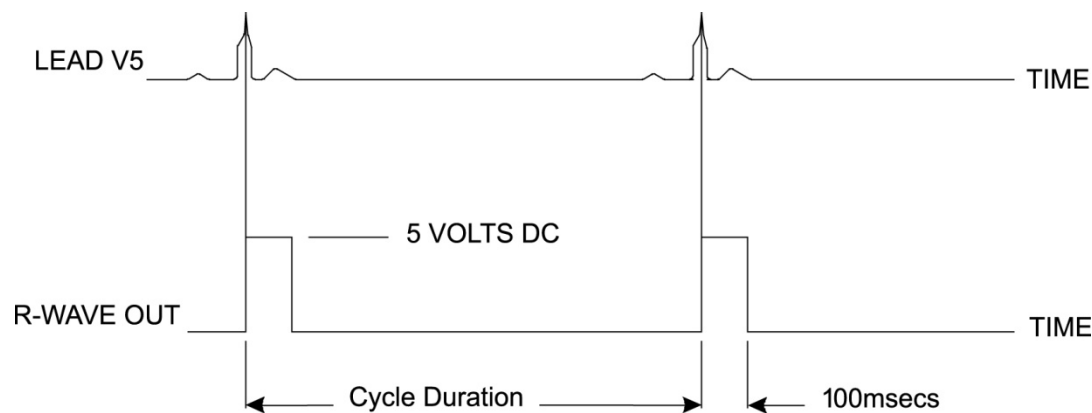

Analog Output

The analog option requires that a cable must be plugged into the appropriate analog output jack on the Trigger Module. The output ECG lead is defined in the Local Settings menu from the Sync Lead drop-down list.

Sample Representation of R-wave Analog Signal Output



NOTE: The interface cable to the Echo device or other equipment requiring an ECG trigger should be supplied by the manufacturer of the equipment requesting the signal, or the facility Biomedical Department. This is a standard RCA to device interface cable.

NOTE: Only use the analog output jack \ominus 1 on the front of the Trigger Module next to ECG A port. Output jacks 2 and 3 on the Trigger Module back are for future use.

Trigger Module Analog and TTL Interface Ports

Trigger Module Front



Q-Stress AM12Q module may be connected to ECG A USB connector on the Trigger Module front. One active analog output connector (1) is also on the front.

Trigger Module Back



The module back includes two non-functional analog output connectors (2 and 3) and one TTL output (TTL) connector.

ECG B connector may also be used with the Q-Stress AM12Q module.

The TTL option requires a BNC male connector on one end with the other end having the connector required by the Echo or device you are interfacing to.

The analog option requires an RCA male connector on one end with the other end having the connector required by the Echo device you are interfacing to.

18. TREADMILL/ERGOMETER HOOKUP

Q-Stress to Treadmill Hookup Instructions with Serial Port Connection

1. Connect one end of the Q-Stress-to-treadmill interface cable to the top 9-pin serial COM1 port on the back of CPU, and the other end to the 9-pin serial port on the treadmill.
2. Connect the treadmill power cord to a dedicated circuit as recommended by the treadmill manufacturer.
3. Open the **Local Settings/F1** menu and enter the appropriate Treadmill COM Port value.
4. Turn the treadmill power switch **ON**.
5. Turn the Q-Stress **ON**.

NOTE: Do not connect the treadmill to the patient isolation transformer. It is important that the treadmill has its **OWN SOURCE OF UNSHARED POWER** to avoid an interruption to the power supply to the Q-Stress. The treadmill should have its own circuit and fuse/breaker in a local power distribution box.

NOTE: Hookup may vary depending on treadmill model version.

Q-Stress to Ergometer Hookup Instructions with Serial Port Connection

1. Connect one end of the Q-Stress-to-ergometer interface cable to the top 9-pin serial COM 1 port on the back of CPU, and the other end to the 9-pin serial port on the ergometer.
2. Connect the ergometer power cord to a dedicated circuit as recommended by the ergometer manufacturer.
3. Open the **Local Settings/F1** menu and enter the appropriate Ergometer COM Port value.
4. Turn the ergometer power switch **ON**.
5. Turn the Q-Stress **ON**.

NOTE: Do not connect the ergometer to the patient isolation transformer. It is important that the ergometer has its **OWN SOURCE OF UNSHARED POWER** to avoid an interruption to the power supply to the Q-Stress. The ergometer should have its own circuit and fuse/breaker in a local power distribution box.

NOTE: Hookup may vary, depending on ergometer model version.

NOTE: When using the Ergoline ergometer with NIBP, you must select the Ergoline from the BP equipment selection in the Local Settings menu.

When an exam is started, the user will select the **Settings** icon in the upper left corner of the display to open the **Local Settings** window where the **Exercise Equipment** type is selected from the drop down list. Once the serial cable is connected to the CPU, it will appear in the **Available COM Ports** list. This number will be entered into the Treadmill or Ergometer COM Port field.

These settings are remembered for all future exams.

Equipment	
Exer Equipment:	Trackmaster (No Se)
BP Equipment:	Manual
AC Frequency:	60
Treadmill COM Port	4
Ergometer COM Port	10
Blood Pressure COM Port	3
Available COM Ports	COM3 COM1 COM2

Q-Stress to Treadmill Hookup Instructions with USB Port Connection

1. Connect one end of the Q-Stress-to-treadmill interface cable to a USB port on the back of CPU, and the other end to the USB port on the treadmill.
2. Connect the treadmill power cord to a dedicated circuit as recommended by the treadmill manufacturer.
3. Open the **Local Settings/F1** menu and enter the appropriate Treadmill COM Port value.
4. Turn the treadmill power switch **ON**.
5. Turn the Q-Stress **ON**.

NOTE: Do not connect the treadmill to the patient isolation transformer. It is important that the treadmill has its **OWN SOURCE OF UNSHARED POWER** to avoid an interruption to the power supply to the Q-Stress. The treadmill should have its own circuit and fuse/breaker in a local power distribution box.

NOTE: Hookup may vary depending on treadmill model version.

Q-Stress to Ergometer Hookup Instructions with USB Port Connection

1. Connect one end of the Q-Stress-to-ergometer interface cable to the USB port on the back of CPU, and the other end to the USB port on the ergometer.
2. Connect the ergometer power cord to a dedicated circuit as recommended by the ergometer manufacturer.
3. Open the **Local Settings/F1** menu and enter the appropriate Ergometer COM Port value.
4. Turn the ergometer power switch **ON**.
5. Turn the Q-Stress **ON**.

NOTE: Do not connect the ergometer to the patient isolation transformer. It is important that the ergometer has its **OWN SOURCE OF UNSHARED POWER** to avoid an interruption to the power supply to the Q-Stress. The ergometer should have its own circuit and fuse/breaker in a local power distribution box.

NOTE: Hookup may vary, depending on ergometer model version.

NOTE: When using the Ergoline ergometer with NIBP, you must select the Ergoline from the BP equipment selection in the Local Settings menu.

NOTE: When using the Lode Corival ergometer with NIBP, you must select the Lode Corival from the BP equipment selection in the Local Settings menu.

When an exam is started, the user will select the **Settings** icon in the upper left corner of the display to open the **Local Settings** window where the **Exercise Equipment** type is selected from the drop down list. Once the USB cable is connected to the CPU, it will appear in the **Available COM Ports** list. This number will be entered into the **Treadmill** or **Ergometer COM Port** field.

These settings are remembered for all future exams.

The screenshot shows the 'Equipment' settings window with the following fields and values:

- Exer Equipment:** Trackmaster (No Se) [Red arrow pointing right]
- BP Equipment:** Manual
- AC Frequency:** 60
- Treadmill COM Port:** 4 [Red arrow pointing right]
- Ergometer COM Port:** 10 [Red arrow pointing right]
- Blood Pressure COM Port:** 3
- Available COM Ports:** [Red arrow pointing left]

The 'Available COM Ports' list at the bottom contains: COM3, COM1, and COM2.

Treadmill Remote Keypad



Increase Speed: Increases speed by 0.1 mph.



Decrease Speed: Decreases speed by 0.1 mph.



Increase Elevation: Increases elevation by 1%.



Decrease Elevation: Decreases elevation by 1%.



12 Lead ECG: Acquires a 12-lead ECG at any time during Pre-exercise, Exercise, Recovery, or Post recovery.



Rhythm Print: Acquires a rhythm strip of the 6 user-definable leads as defined in Settings. Depress a second time to change to leads I, II, III, aVR, aVL, and aVF. Depress a third time to change to leads V1, V2, V3, V4, V5, and V6. Depress a fourth time to revert back to original 6 leads.



Stop Rhythm Printing: Stops rhythm strip from printing.



Phase Advance: Advances to the next phase.



Advance Stage: Advances to the next stage.



Acquire NIBP: Send a signal to the NIBP device to acquire a NIBP.

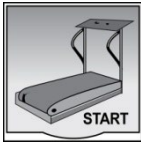

Start Treadmill: Starts treadmill belt at the speed set in the Pre-exercise phase.

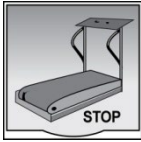

Stop Treadmill: Stops treadmill.

19. CONFIGURE PRINTER

Z200+ Thermal Printer

The Z200+ thermal printer uses an eight-dot-per-millimeter (dpm) print head to print ECG tracings and report data. Multiple print formats, and standard (8.5" x 11") or A4 thermal paper sizes are supported.

The Z200+ thermal printer includes:

- Hospital-grade power cord for connection to the isolation transformer.
- USB cable for connection to the PC. (Previous models use crossover network cable)

Figure 5 Z200+ Thermal Printer

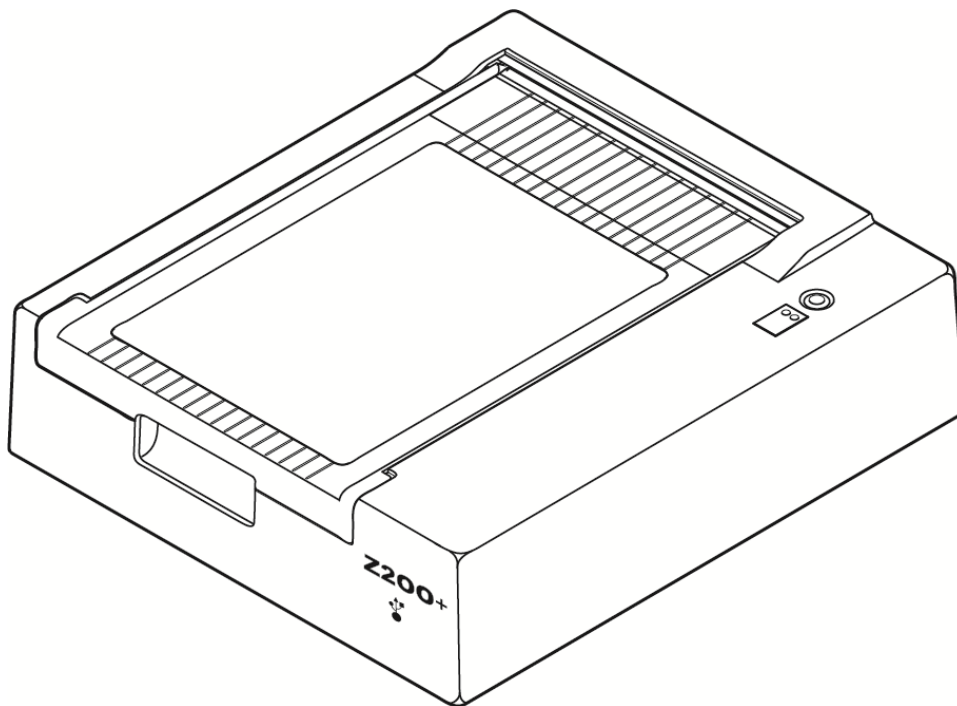

Z200+ Thermal Printer Specifications

Feature	Specification*
Instrument Type	Thermal printer
Paper Type	A size paper (8 ½ x 11 in., 215 x 280 mm), A4 size (8.27 x 11.69 in., 210 x 300 mm), or SmartFormat Paper (8.27 x 11 in., 210 x 280 mm) cued, perforated, Z-fold with full grid
Recording Technique	Computer controlled, thermal dot array, 8 dots/mm
Writer Speeds	5, 10, 25, or 50 mm/sec, computer controlled
External Ports and Data Interfaces	USB connection to PC to allow high-speed data transfer for printing External USB connector (Legacy models use crossover network cable for connection)
Chassis Leakage Current	Meets or exceeds requirements of IEC 60601-1 Part 1, Edition 3.1
Power	100-240 VAC at 50/60 Hz
Weight	9 lbs. or 4.09 kg
Dimensions H x W x D	4" x 16" x 13" (10 cm x 41 cm x 33 cm)
Fuses	T-Type 1 Amp, 250 V
Special Functions	USB communication that provides continuous printing (Legacy models use LAN communication)

* Specifications subject to change without notice

Input and Output Descriptions

Feature	Description
AC Power	The Z200+ thermal printer operates on 120/240 VAC at 50/60 Hz. Power is supplied as soon as the AC power cord is connected to an AC power outlet.
Power-On Indicator	This indicator will illuminate in green when AC power is applied.
Form Feed/Reset Button	The form-feed pushbutton is a momentary contact switch that advances the paper until an infrared, reflective sensor detects a "cue mark" on the printing side of the paper. This button will reset the thermal printer when it is depressed for a period of seven seconds.
Hard-Copy Printout	The Z200+ thermal printer is compatible with size A, A4, and SmartFormat Z-folded, thermal-sensitive paper with cue marks. Printing speeds are 10, 25, and 50 mm/second. Dot density is eight dots per millimeter or 203.2 dpi.
Paper Out/Writer Error Indicator	This indicator will illuminate in green when writer-error conditions are detected. Errors include not detecting a cue mark at the expected time (due to a paper jam or

Feature	Description
	drive system failure) and detecting a cue mark longer than expected. The writer error will remain illuminated until the form-feed button is depressed.
Connection Loss Indicator	The indicator will flash if connection to the PC is lost. The flashing will stop when connection is reestablished.

Setting Up the Z200+ Thermal Printer

Check to see whether the Z200+ has a USB or Integrated network (LAN) connector and follow the corresponding directions below.

To Set up a Printer with a USB connection

1. Begin by ensuring the Q-Stress application is installed on the PC. If it is not, install the application using the software installation instructions earlier in this manual. When the Q-Stress application is installed, install the QStressNetworkProxy Windows service from the Z200+ installation CD.

- a. From the installation CD, run the setup.exe file as an administrative user.
- b. Follow the prompts to install the service. It is recommended to restart the PC after installation.

NOTE: The install location will be C:\Program Files\Welch Allyn\QStressNetworkProxy and the QStressNetworkProxy service will be installed as an automatic service on the PC.

- c. After installation is complete, go to C:\Program Files\Welch Allyn\QStressNetworkProxy\ and run the application QStressNetworkProxy (x64).exe with admin rights. This will automatically install any additional required software, if necessary.

NOTE: The QStressNetworkProxy service will save logs to C:\ProgramData\Welch Allyn X-Scribe\Logs This is this is the same folder used for the Q-Stress application logs. The log file names will follow the naming convention Z200PlusProxy_LogFile_#.txt where '#' is the day of the current month.

2. Once the software is installed, connect the AC power cord to the AC connector on the printer and to the isolation transformer.
3. Connect one end of the USB cable to the USB B connector on the Z200+ thermal printer and the other end to the USB A connector on the back of the Q-Stress PC.

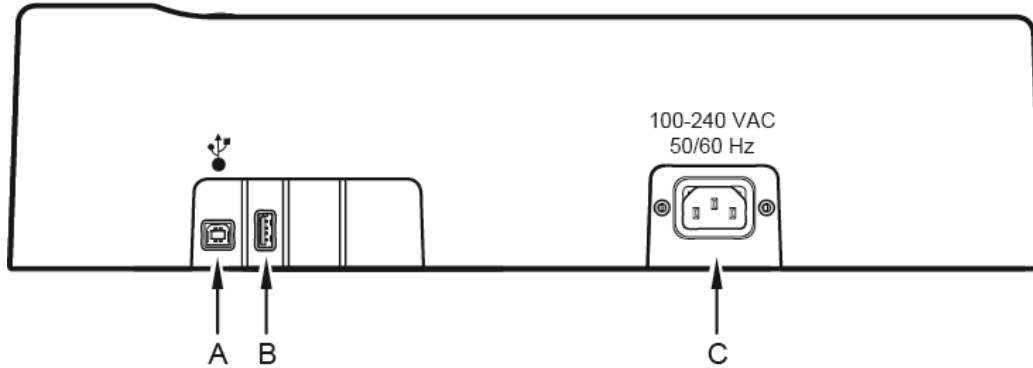
Figure 6 USB Z200+ Thermal Printer Connectors

A USB B connector.

C AC connector (for power cord)

B USB A connector. Not used.

The Z200+ thermal printer operates on line power and is controlled by a USB connection to the Q-Stress.

To Set up a Printer with an Integrated Network (LAN) connection

1. Connect the AC power cord to the AC connector on the printer and to the isolation transformer .
2. Connect one end of the crossover network cable to the network connector on the Z200+ thermal printer and the other end to the network (LAN) connector on the back of the Q-Stress PC.

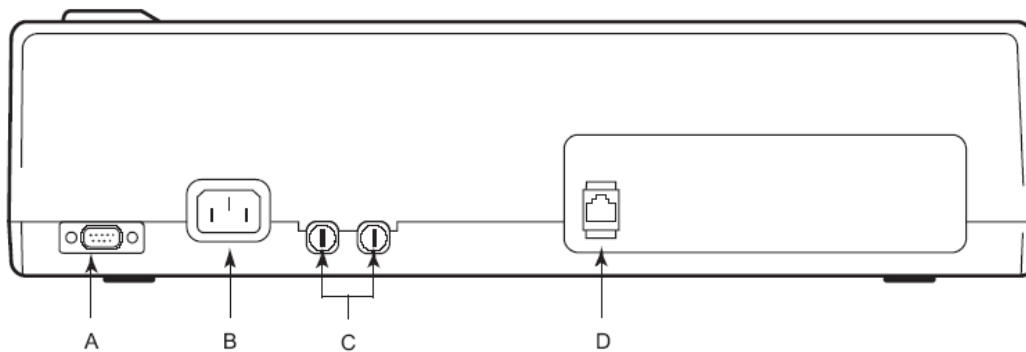
Figure 7 Integrated Network Z200+ Thermal Printer Connectors

A Serial connector. Not used.

C AC fuses

B AC connector (for power cord)

D Integrated network (LAN) connector

The Z200+ thermal printer operates on line power and is controlled by a LAN connection to the Q-Stress.

To Configure the LAN Connection for the Printer

1. On the Q-Stress PC, log in as Administrator.
2. Click **Start > Settings > Control Panel**.
3. Double click **Network Connections**.
4. Double click the appropriate **Local Area Network** icon. The Local Area Connection Properties dialog box will appear.
5. In the items list, select **Internet Protocol (TCP/IP)**, and click **Properties**. The Properties dialog box will appear.

Network settings are:

IP Address: 192.168.10.100

Subnet Mask: 255.255.255.0

Default Gateway: 192.168.10.1

6. Click OK in each dialog box to save the entries and exit.

Maintaining the Z200+ Thermal Printer

If the hospital or institution fails to implement a satisfactory cleaning and inspection schedule for this equipment, it may result in equipment failure and health hazards.

***NOTE:** Only qualified service personnel should repair or replace Z200+ thermal printer parts.*

Inspect the equipment for the following conditions on a regular basis:

- Examine power cable and communication cable for obvious damage (i.e., torn insulation, broken connectors, etc.). Replace cables as necessary.
- All cords and connectors are securely seated in their corresponding connections.
- Examine the equipment for missing screws, cracks, or broken areas that might allow unintended access to internal electronics areas.

Cleaning the Z200+ Thermal Printer

***NOTE:** If using a laser printer, refer to the printer user manual for maintenance and cleaning instructions.*

To clean the printer:

1. Disconnect the power source.
2. Clean the exterior surface of the unit with a damp cloth using a solution of mild dishwashing detergent diluted in water.
3. After washing, thoroughly dry off the unit with a clean, soft cloth or paper towel.

To clean the print head:

NOTE: Do not let soap or water come into contact with the writer, plugs, jacks, or vents.

1. Open writer door.
2. Lightly rub print head with an alcohol pad.
3. Wipe with a clean cloth to remove alcohol residue.
4. Allow print head to air dry.
5. Clean the platen by using adhesive tape. Apply the tape and pull it off. Rotate roller and repeat until entire roller is clean.
6. Clean cue sensor photo detector.

Testing Printer Operation

After cleaning and inspecting the Z200+ thermal printer, confirm the printer is working properly.

To test printer operation:

1. Using an ECG simulator with the Q-Stress, acquire and print ECGs of known amplitude.

A successfully printed ECG report has the following characteristics:

1. Printing should be dark and even across the page.
2. There should be no evidence of print head dot failure (i.e., breaks in printing forming horizontal streaks).
3. Paper motion should be smooth and consistent during printing.
4. Waveforms should appear normal, with proper amplitude, and without distortion or excessive noise.
5. Paper should stop with perforations near the tear bar (indicating proper cue sensor operation).

Post Service Testing

Following any service to the Z200+ thermal printer or when non-compliant operation is suspected, Welch Allyn recommends the following procedures:

- Confirm proper operation as described in *Testing Printer Operation*.
- Perform testing to ensure continued electrical safety of the device (use IEC 60601-1 Part 1, Edition 3.1 methods and limits).
 - Earth leakage current.

NOTE: *There is no exposed metal and no patient connection to this unit.*

Loading the Thermal Printer Paper

Figure 8 Loading the Thermal Printer Paper

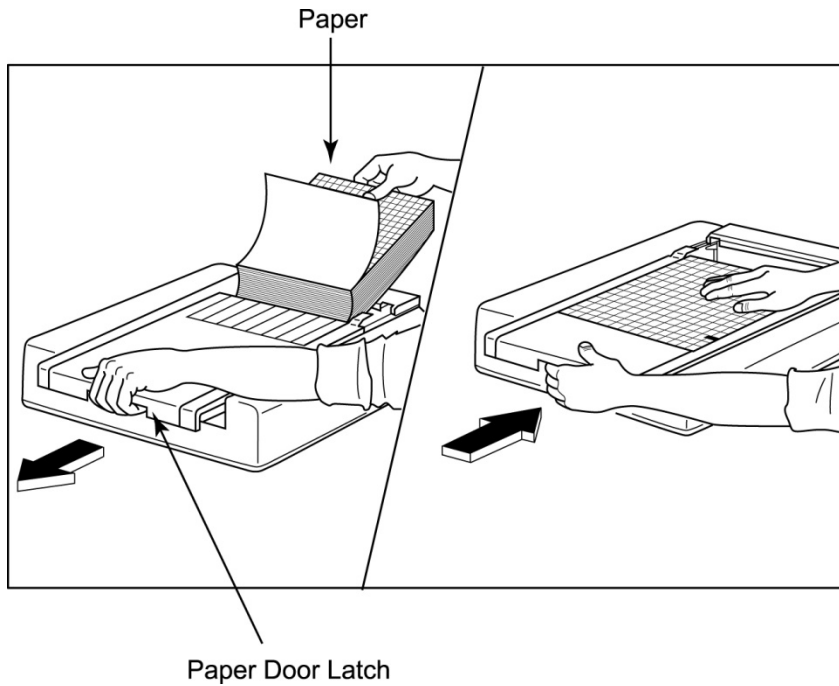

1. Remove the outer packaging from the paper stack.
2. Facing the front of the unit, use the release latch on the left side and slide the paper tray cover to the left.
3. Place the pack of thermal paper into the paper tray such that the grid side of the paper is up when it is pulled over the paper tray cover. The paper cue mark (a small black rectangle) should be in the lower left corner.
4. Manually advance one page of paper beyond the closure point of the writer. Make sure the paper lies on the black roller evenly within the channel of the paper door.
5. Slide writer cover to the right until the cover latches in a locked position. You will hear a sharp click when the door is properly latched.
6. Push the form-feed button to align the cue mark and prepare the paper for printing.

A4 Paper Spacer Insertion

If your Z200+ thermal writer was ordered with A4 paper, the paper-tray spacer needs to be inserted in the paper tray. A paper-tray spacer will not be provided if the device was purchased with standard paper.

To insert the paper-tray spacer:

Figure 9 Insert the Paper Tray Spacer

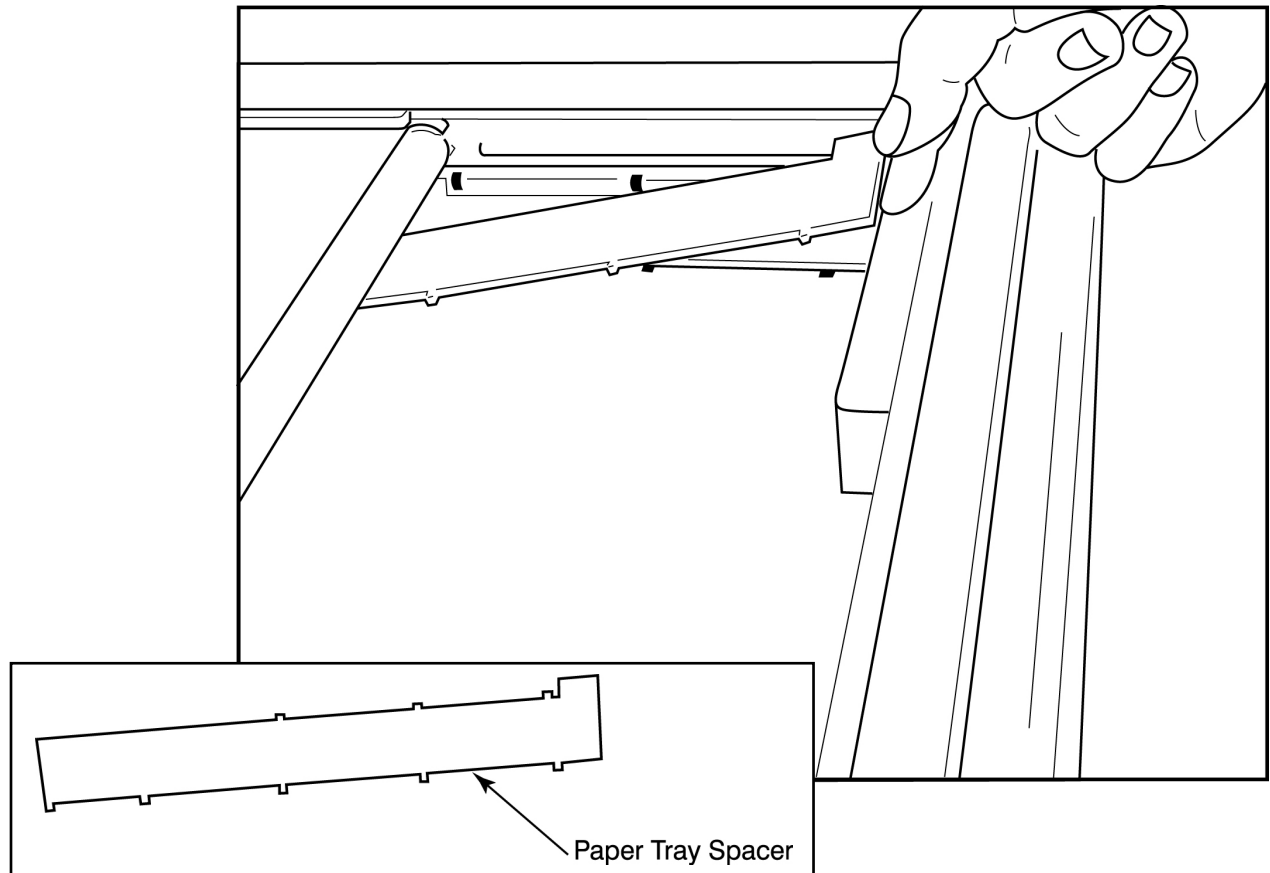

1. Slide paper-tray spacer towards rear wall of writer tray. Align the bottom four plastic arms with the four openings in the base of the writer tray. Similarly, align the top 3 plastic arms with the three openings on the rear wall of the writer tray.

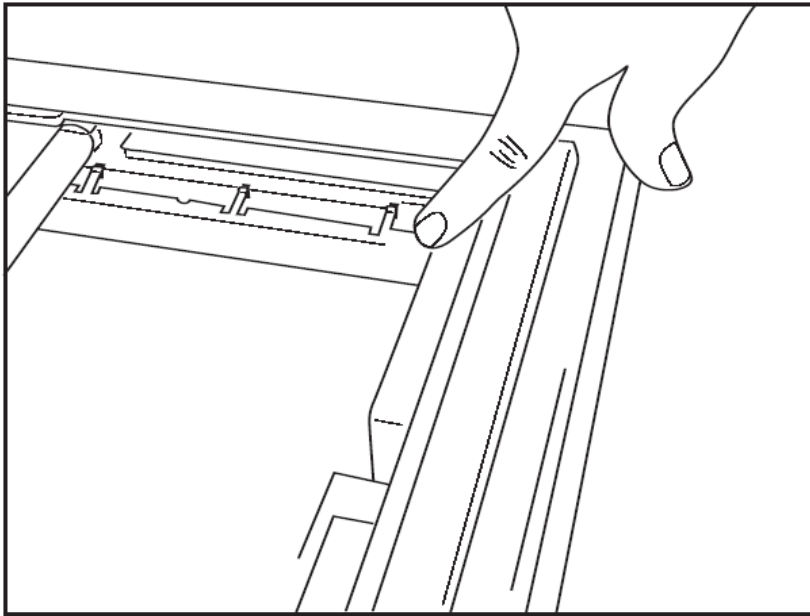
Figure 10 Insert the Paper Tray Spacer

2. The paper-tray spacer should be parallel to the rear wall of the writer tray as pictured above.

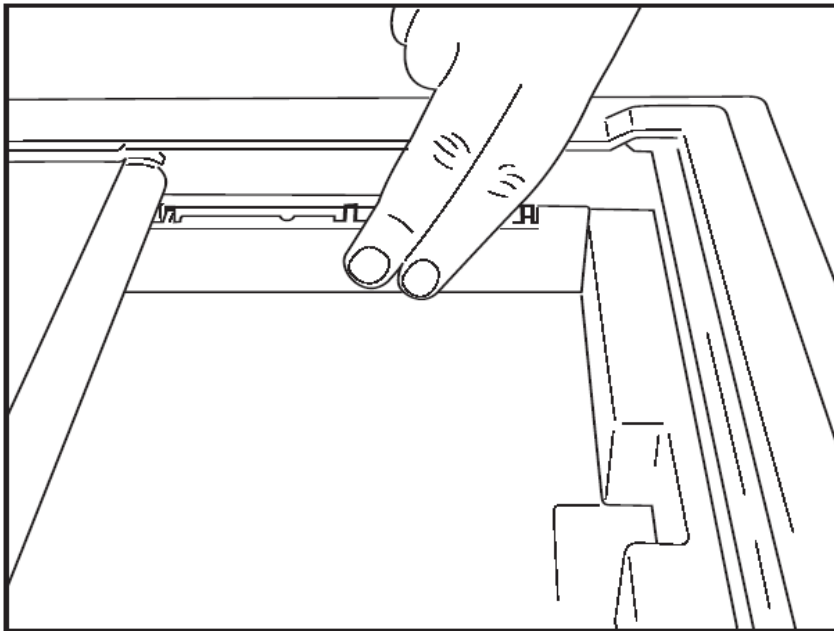

3. Gently press paper-tray spacer in place.

NOTE: If you wish to remove the paper-tray spacer, gently press on the top three plastic arms to remove.

Troubleshooting Chart

Issue	Solution
No Printing	<p>Check to see that the LAN Connection properties on the system computer are defined correctly.</p> <p>Ensure that the proper connection cable is used per set up instructions above and check connections.</p> <p>Check AC power cord connections and confirm that the Power-On indicator is illuminated.</p> <p>Check to see that paper has been loaded.</p> <p>Check to see that no error indicator lights are illuminated. If the error indicator is on, depress the black form-feed button for approximately 10 seconds to reset the printer. If the problem persists, contact technical service.</p> <p>Check to see that the proper Welch Allyn paper is being used.</p>
Distorted printing	<p>Check with Welch Allyn Service to ensure that the correct firmware version is installed on the Z200+ printer.</p>
Uneven printing	<p>Possible causes of uneven printing could be the print head itself, the platen, poor or damaged paper, or the mechanical alignment of the print head. Have a technician check the platen for uneven wear and check that the print head shoulder screws are secure before replacing the print head. The shoulder screws which secure the print head should be properly centered in their holes, allowing the print head slight vertical movement.</p>
Printing too light or too dark	<p>Change the Waveform Print radio button to Normal or Bold in the System Configuration Modality Settings under the Miscellaneous tab. Contact Welch Allyn Technical Service Department for assistance if this does not resolve the problem</p>
Gaps in Printing	<p>Have a technician check the power head cable and the signal cable for shorts, opens, or damaged connectors. These cables plug in between the circuit board and the thermal print head. If the cables are all right, then the problem could be either the print head or the circuit board, or defective paper.</p>
Defective Paper	<p>Thermal paper which is old or which was improperly stored can cause light or uneven printing. Exposure to heat or chemical vapors can damage the paper. Test your Z200+ thermal writer using a fresh pack of properly stored paper.</p>
No Motor Drive	<p>The problem of no motor drive could be caused by insufficient paper tension, a faulty writer assembly, or a faulty circuit board.</p>

20. SUNTECH TANGO+ AND TANGO M2 INTERFACE

SunTech Tango+ Blood Pressure (BP) Monitor and Q-Stress Connections

To setup Tango+ with the Q-Stress system, follow the directions below.

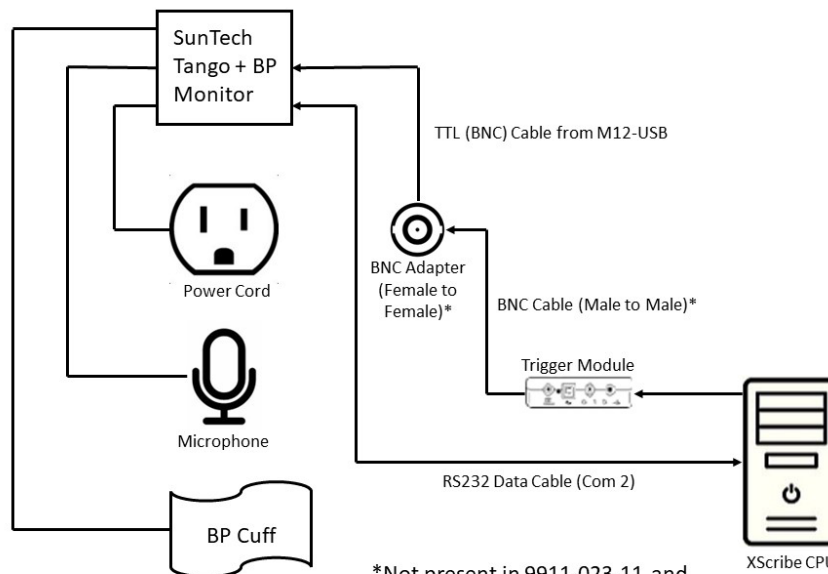
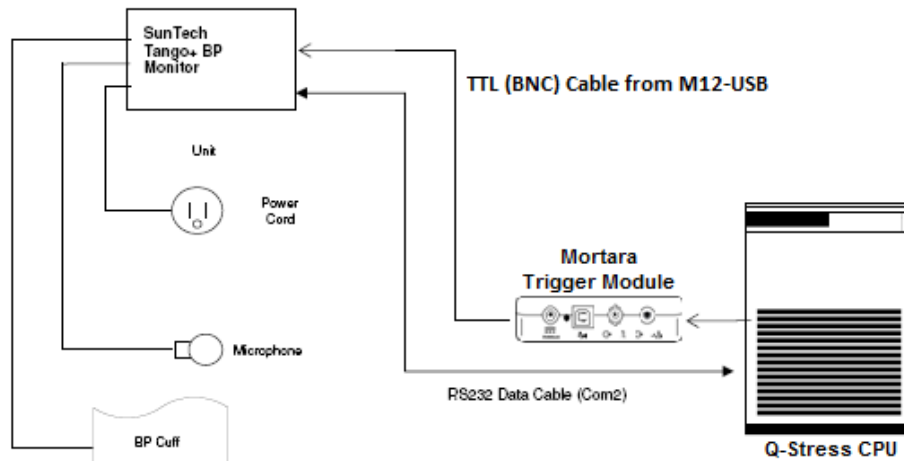

*Not present in 9911-023-11 and 9911-023-12 base assemblies

1. Connect the RS-232 cable (SunTech Part Number 91-0013-00) to the 9-pin connector on the rear panel of the Tango+, and the other end to the COM 2 port on the back of the Q-Stress CPU.
2. If using the Q-Stress cart 9911-023-011 or 9911-023-12 without a BNC connector (see “Front End and Trigger Module Connection”), connect the ECG Trigger Cable (SunTech Part Number 91-0011-00) to the BNC external ECG connection on the rear panel of the Tango+, and the other end to the TTL output connection on the Trigger Module. If using the Q-Stress cart 775412 or 775413 with a BNC connector,

connect the ECG trigger cable to the BNC connector on the back of the cart instead of directly to the Trigger Module.

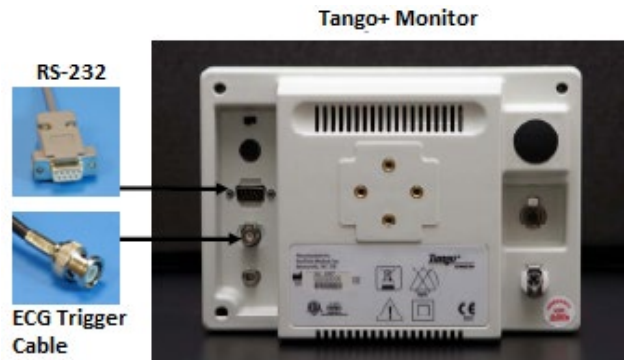

Tango+ BP Monitor Setup

1. When the operating screen is displayed, press the **SELECT** button twice to display the **MAIN MENU**.
2. Use the **UP/DOWN** arrows to highlight **MONITOR SET UP** and press the **SELECT** button.
3. Use the **UP/DOWN** arrows to highlight **STRESS SYSTEM** and press the **SELECT** button.
4. Use the **UP/DOWN** arrows to scroll through the list until **X-Scribe II** is highlighted and press the **SELECT** button to confirm.
5. Use the **UP/DOWN** arrows to select **EXIT** twice to return to the operating screen.

SunTech Tango M2 Blood Pressure (BP) Monitor and Q-Stress Connections

To setup Tango M2 with the Q-Stress system, follow the directions below.

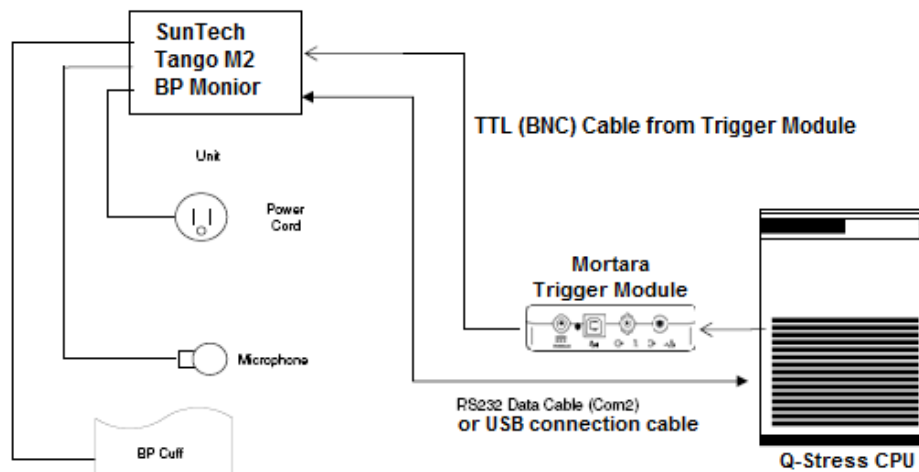

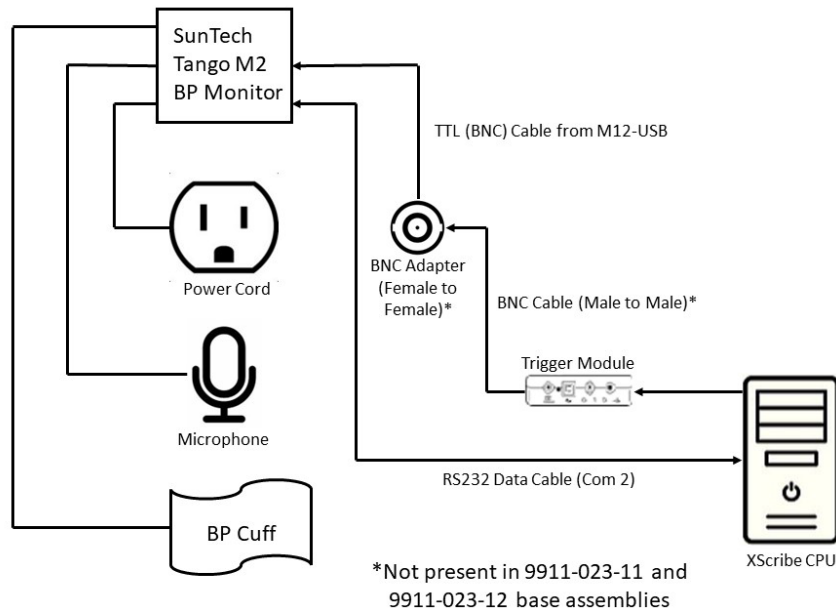

1. Connect the RS-232 cable (SunTech Part Number 91-0013-00) to the 9-pin connector on the rear panel of the Tango M2, and the other end to the COM 2 port on the back of the Q-Stress CPU
OR
Connect the USB cable to the rear panel of the Tango M2, and the other end to any available USB port on the back of the Q-Stress CPU.
2. If using the Q-Stress cart 9911-023-011 or 9911-023-12 without a BNC connector (see “Front End and Trigger Module Connection”), connect the ECG Trigger Cable (SunTech Part Number 91-0011-00) to the BNC external ECG connection on the rear panel of the Tango M2, and the other end to the TTL output connection on the Trigger Module. If using the Q-Stress cart 775412 or 775413 with a BNC connector, connect the ECG trigger cable to the BNC connector on the back of the cart instead of directly to the Trigger Module.

NOTE: If this port is already in use, a BNC Splitter may be needed (SunTech Part Number 64-0080-00).



Tango M2 Blood Pressure (BP) Monitor Setup

1. When the operating screen is displayed, press the **SELECT** button once to display the **MAIN MENU**.
2. Use the **UP/DOWN** arrows to highlight **MONITOR SET UP** and press the **SELECT** button.
3. Use the **UP/DOWN** arrows to highlight **STRESS SYSTEM** and press the **SELECT** button.
4. Use the **UP/DOWN** arrows to scroll through the list until **X-Scribe** is highlighted and press the **SELECT** button to confirm.
5. Use the **UP/DOWN** arrows to select **EXIT** twice to return to the operating screen.

Q-Stress System Setup

1. While the Observation Phase is displayed, select the **Settings** button to display Local Settings pop up menu.
2. From the BP Equipment drop-down list, select **Tango or Tango M2** and then click **OK**.

The selected setting is remembered for all future stress tests. However, this selection can be changed on a per-exam basis. The BP pop up window also allows a change from automatic to manual BP with a checkbox when necessary during an exam.

The Q-Stress blood pressure entry control for Exercise and Recovery phases will now automatically initiate and acquire BP readings and optional SpO2 values from the SunTech Tango BP Monitor.

Refer to the SunTech Tango+ or Tango M2 Stress BP User's Guide included with the BP Monitor for information about indications for use, warnings and contraindications, BP monitor operation, patient preparation, maintenance, and troubleshooting information. This information is also available at the SunTech Medical website: www.suntechmed.com.

21. USER ROLE ASSIGNMENT TABLE

	IT Admin	Clinical Admin	Schedule Procedure	Patient Hookup	Prepare Report
Main Screen					
Schedule / Orders	No	Yes	Yes	No	No
Start a Stress Test	No	No	No	Yes	No
Exam Search	No	Yes	No	No	Yes
User Preferences	Yes - No Status Filter	Yes - No Status Filter	Yes - No Status Filter	Yes - Filter Acquired only	Yes - Filter Acquired and Edited only
System Configuration	Yes - No Modality Settings, CFD or Report Settings	Yes - Audit Trail, Service Logs, Report Settings, Modality Settings and CFD	Yes - Service Logs only	Yes - Service Logs only	Yes - Service Logs only
Exam Search					
Edit	No	No	No	No	Yes - Acquired and Edited Exams only
Report	No	No	No	No	No
Copy Offline	No	Yes	No	No	No
Open Offline	No	No	No	No	Yes
Export	No	No	No	No	No
Reconcile	No	Yes (Signed only)	No	No	No
Archive	No	Yes	No	No	No
Delete	No	Yes	No	No	No
Editing Permissions					
Summary Tables	No	No	No	No	Yes
Conclusions Section	No	No	No	No	Diagnosis, Reason For End and Technician
Patient Data	No	No	No	Patient and Contact Fields - only after Acquisition	Admission ID, Indications, Referring Physician, Procedure type, Location, Notes, and Technician
Page Review	No	No	No	No	Yes - View/Add/Edit Events and Print
Update Exam State	No	No	No	Acquired only	Edited only

	Review and Edit Report	Sign Report	Edit Conclusions	Export Report	View Exams/Reports
Main Screen					
Schedule / Orders	No	No	No	No	No
Start a Stress Test	No	No	No	No	No
Exam Search	Yes	Yes	Yes	Yes	Yes
User Preferences	Yes	Yes	Yes - Filter Acquired and Edited only	Yes - No Status Filter	Yes - No Status Filter
System Configuration	Yes - Service Logs only	Yes - Service Logs only	Yes - Service Logs only	Yes - Service Logs only	Yes - Service Logs only
Exam Search					
Edit	Yes - Acquired, Edited, Reviewed Exams only	Yes	Yes - Acquired and Edited Exams only	No	Yes
Report	No	No	No	No	Yes - Reviewed and Signed Exams only
Copy Offline	No	No	No	No	No
Open Offline	Yes	Yes	Yes	No	Yes
Export	No	No	No	Yes - Reviewed and Signed Exams only	No
Reconcile	Yes (Not Signed)	Yes (Not Signed)	No	No	No
Archive	No	No	No	No	No
Delete	No	No	No	No	No
Editing Permissions					
Summary Tables	No	No	No	No	No
Conclusions Section	Symptoms and Conclusions	Symptoms and Conclusions	Symptoms and Conclusions	No	No
Patient Data	No	No	No	No	No
Page Review	Yes - View and Print only	View and Print only	Yes - View and Print only	No	Yes - View and Print only
Update Exam State	Reviewed only	Signed only	Edited only	No	No - Screen is not shown

22. Q-STRESS DATA EXCHANGE CONFIGURATION

Data Exchange Interfaces

The Q-Stress can exchange data with other information systems using file exchange and/or DICOM®. HL7 is also possible by adding Welch Allyn's HL7 Gateway to the solution.

All data exchange is performed by the central Q-Stress Server (aka Modality Manager); all Q-Stress workstations connected to the dedicated Q-Stress Server share the same data exchange settings.

Glossary

Term	Definition
Ordered Test	A diagnostic test that has been electronically ordered by an authorized caregiver. Scheduling may be a separate step, or "now" may be implied by the ordering system.
Scheduled Test	An ordered test that has also been scheduled to be performed at a specific time. It could be scheduled for now, any time today, a specific date, and/or a specific time.
Q-Stress Server or Modality Manager	The database used to organize and store patient and test data. It may reside on the local Q-Stress computer, a remote Q-Stress computer, or on a central server. A Q-Stress is associated with one and only one Q-Stress Server (Modality Manager).
Ad Hoc Test	A test that is performed without an electronic order.
Q-Stress Desktop	The application desktop that displays the icons for such tasks as performing a test, editing a test, finding a test, finding a patient, etc.
SCP	Service Class Provider. In DICOM, this is the "server" that listens for connections from clients.
SCU	Service Class User. In DICOM, this is the "client" that initiates the connection to the SCP.
MWL	DICOM Modality Worklist.

Network Topologies

The simplest installation is a standalone Q-Stress with a local Server.

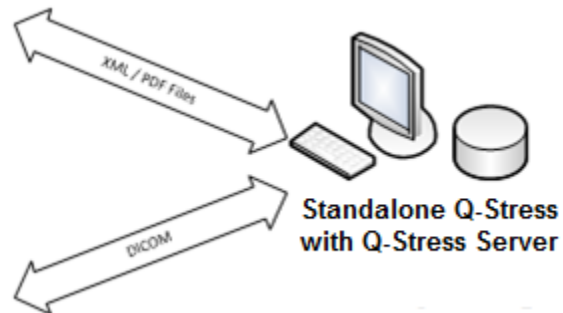

A small number of Review Stations can be networked to a Q-Stress that hosts the central server (Modality Manager).

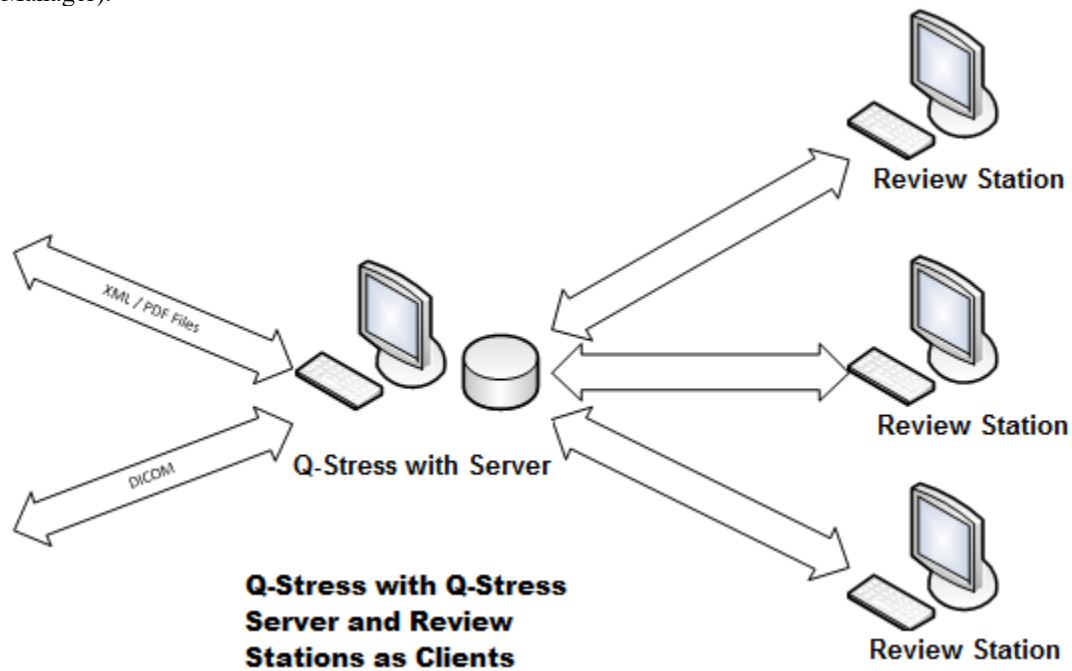

A central dedicated Q-Stress Server can be hosted on server hardware with any number of Q-Stress workstations as clients. Any 3rd party information system can exchange XML and PDF files with the Q-Stress Server.

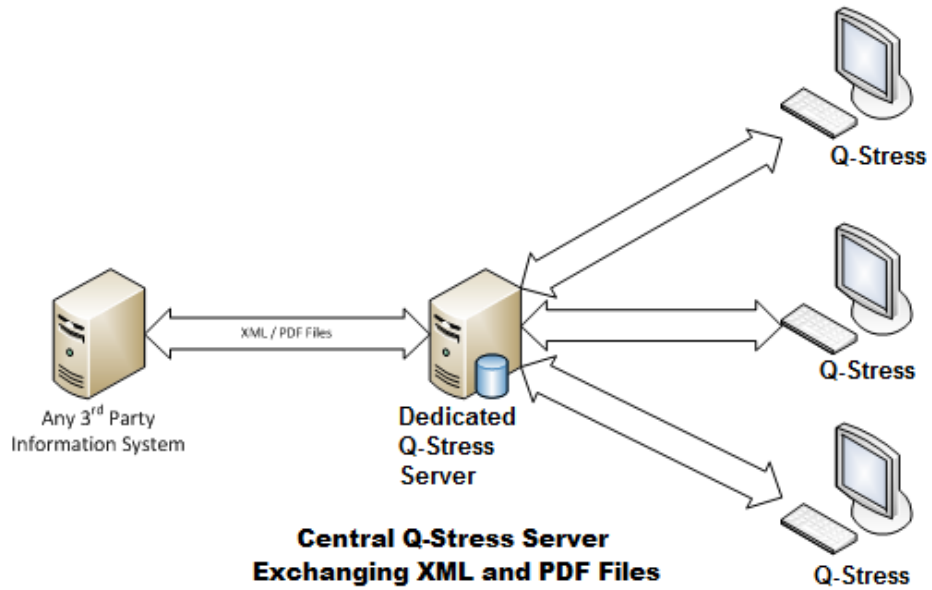

A Welch Allyn HL7 Gateway can be added to the solution to enable exchange of HL7 messages between HIS and EMR systems and the central Q-Stress Server.

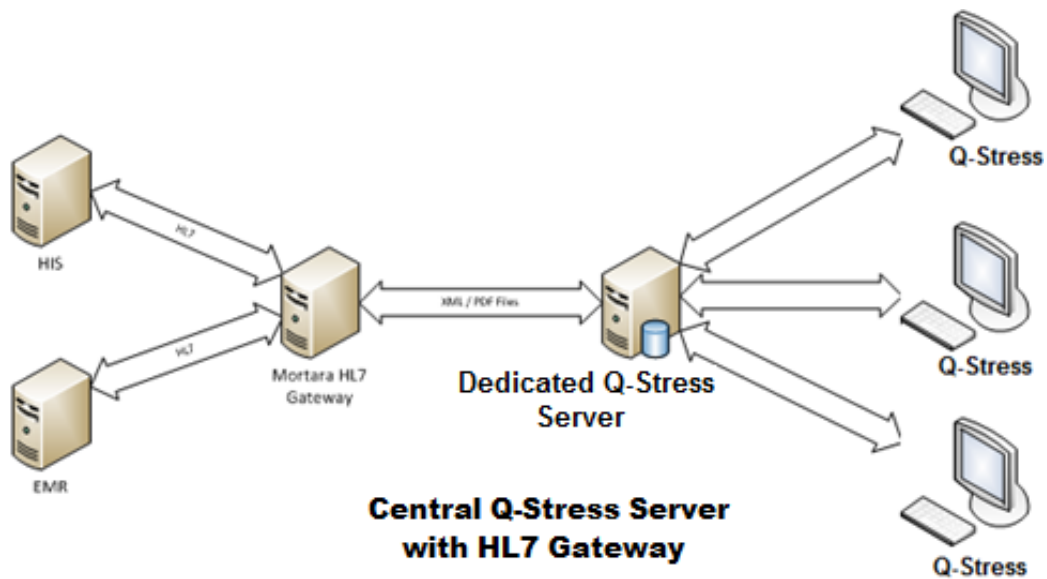

The central Modality Manager can exchange DICOM messages with a cardiology PACS system.

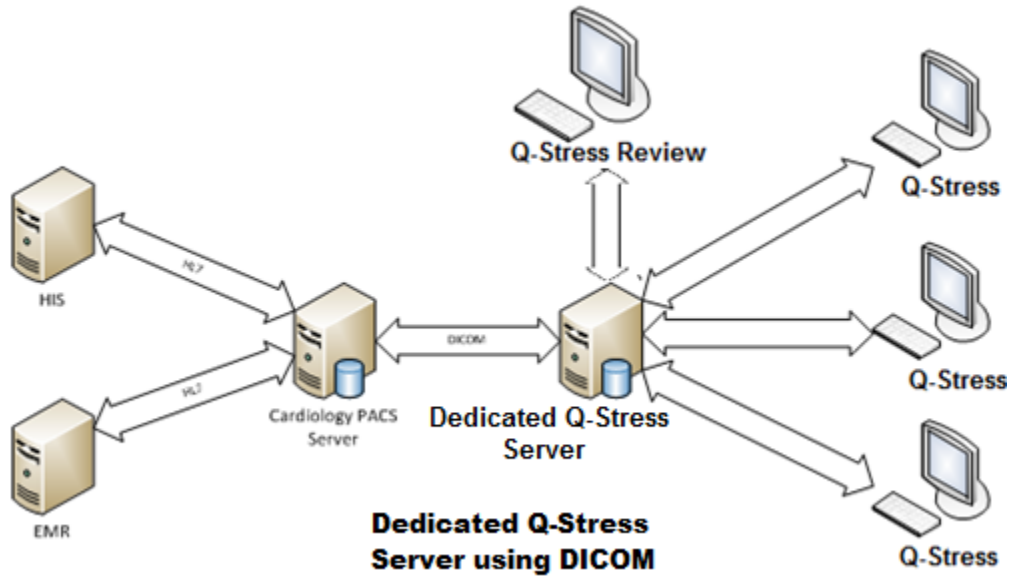

DICOM

When the Q-Stress Server is configured for DICOM, all ordered/scheduled test information comes from the MWL SCP. If an ad hoc test needs to be performed, just start the test and enter new demographics at that time.

Configuring DICOM

Q-Stress users with “IT Administrator” permission can configure the Q-Stress Server DICOM settings. Log into any Q-Stress computer associated with the Q-Stress Server to be configured. Launch any of the Q-Stress Stations to start a Q-Stress Desktop. Click on **System Configuration**.



Then select **DICOM Settings**.

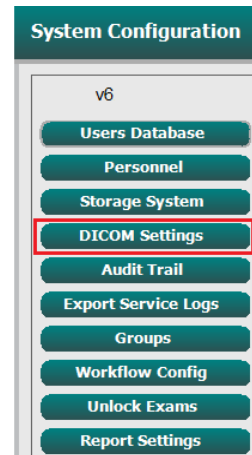

The DICOM settings are organized on 3 tabs: SCP Settings, Storage Settings, and Miscellaneous.

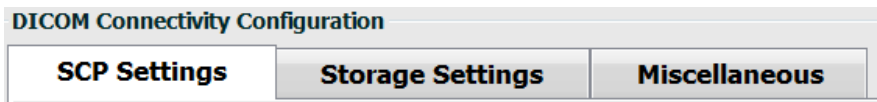

SCP Settings

Service Class Provider (SCP) settings contain the communication settings used for Modality Worklist (MWL), C-STORE, Modality Performed Procedure Step (MPPS), and Storage Commitment.

The screenshot shows the 'DICOM Connectivity Configuration' window with the 'SCP Settings' tab selected. The 'SCU AE Title' is set to 'MORTARA'. The settings are organized into four sections: MWL, C-STORE, MPPS, and Storage Commitment. MWL settings include 'Enable MWL' (checked), 'SCP Host Name or IP' (mwl.cpacs.demohospital.org), 'SCP TCP Port Number' (104), and 'SCP AE Title' (MWL_CPACS). C-STORE settings include 'Enable Storage' (checked), 'SCP Host Name or IP' (cstore.cpacs.demohospital.org), 'SCP TCP Port Number' (104), and 'SCP AE Title' (CSTORE_CPACS). MPPS settings include 'Enable MPPS' (unchecked), 'SCP Host Name or IP' (empty), 'SCP TCP Port Number' (0), and 'SCP AE Title' (empty). Storage Commitment settings include 'Enable Storage Commitment' (unchecked), 'SCP TCP Port Number' (0), and 'SCU Response TCP Port Number' (0).

SCP	Setting	Description
Modality Worklist (MWL)	Enable MWL	Check to enable MWL.
	SCP Host Name or IP	DNS hostname or IP address of the SCP.
	SCP TCP Port Number	TCP/IP port number of the MWL service.
	SCP AE Title	Application Entity (AE) Title of the SCP.
C-STORE	Enable Storage	Check to enable storage of results (Encapsulated-PDF for stress reports). This checkbox enables storage for all Q-Stress workstations connected to the central Modality Manager.
	SCP Host Name or IP	DNS hostname or IP address of the SCP. If Storage Commitment is also enabled, it will communicate with this same SCP host.
	SCP TCP Port Number	TCP/IP port number of the storage service.
	SCP AE Title	Application Entity (AE) Title of the SCP. If Storage Commitment is also enabled, it will communicate with this same AE Title.
Modality Performed Procedure Step (MPPS)	Enable MPPS	Check to enable MPPS status messages.
	SCP Host Name or IP	DNS hostname or IP address of the SCP.
	SCP TCP Port Number	TCP/IP port number of the MPPS service.
	SCP AE Title	Application Entity (AE) Title of the SCP.
Storage Commitment	Enable Storage Commitment	Check to enable Storage Commitment.
	SCP TCP Port Number	TCP/IP port number of the Storage Commitment service.
	SCU Response TCP Port Number	TCP/IP port the Q-Stress Server will use to listen for Storage Commitment responses.

Storage Settings

These settings specify how to store the results of the tests.

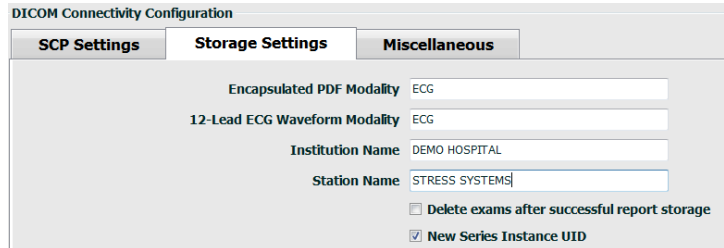

DICOM Connectivity Configuration

SCP Settings **Storage Settings** Miscellaneous

Encapsulated PDF Modality: ECG

12-Lead ECG Waveform Modality: ECG

Institution Name: DEMO HOSPITAL

Station Name: STRESS SYSTEMS

Delete exams after successful report storage

New Series Instance UID

Setting	DICOM Tag	Description
Encapsulated PDF Modality	(0008,0060)	Modality value stored in the encapsulated-PDF objects from stress tests. Normally set to "ECG".
12-Lead ECG Waveform Modality	(0008,0060)	Modality value stored in the 12-Lead ECG Waveform objects from resting ECG tests. Normally set to "ECG".
Institution Name	(0008,0080)	Name of institution or department that performed the test.
Station Name	(0008,1010)	Station Name that performed the test. Station name is configured per workstation in Local Settings and will use the computer name by default when not user-configured. Text entered in this Storage Settings field is only used when the Local Settings Station Name field is blank.
Delete exams after successful report storage		Check if the exam data should automatically be deleted after the DICOM PDF or waveform has been stored. Only use this option if you're sure you'll never need to amend the test results later. This option is only active when Storage Commitment is used.
New Series Instance UID		When checked, and the test results are amended and signed again, the DICOM PDF or waveform will be given a different Series Instance UID from the previous ones used for this test.
Enable file export on storage		Check if PDF and XML files should be exported. The "Enable Storage" box must also be checked on the SCP Setting tab.
Export Folder Path		Path where PDF and XML files will be placed when the test is signed. This can be a UNC path to a network file share.
Export User Name		The username to use when writing to the export folder.
Export Password		The password corresponding to the username.
Export Domain		The domain the username is from.

Miscellaneous Settings

This tab contains other settings.

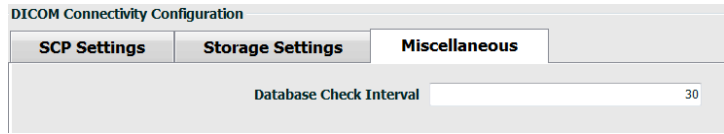

Setting	Description
Database Check Interval	<p>Specifies the number of seconds between each MWL query.</p> <p><i>Note: when a Q-Stress workstation displays the MWL, it does not display the list it just retrieved from the MWL SCP. Instead, it displays the MWL most recently retrieved by the Q-Stress Server. If the interval is set to 30 seconds, the MWL displayed by the Q-Stress is at most 30 seconds old. If set to 600 seconds, then it could be up to 10 minutes old. Using a small number ensures the list is up-to-date. However, a small number could overload the MWL SCP with frequent queries.</i></p>

MWL Settings

Q-Stress users with “IT Administrator” permission can configure the Q-Stress Server DICOM settings. Log into any Q-Stress computer associated with the server to be configured. Launch any of the Q-Stress workstations to start a Q-Stress Desktop. Click on **System Configuration**.



MWL Settings are per Group, so first select the appropriate Group, and then select **MWL Settings**.

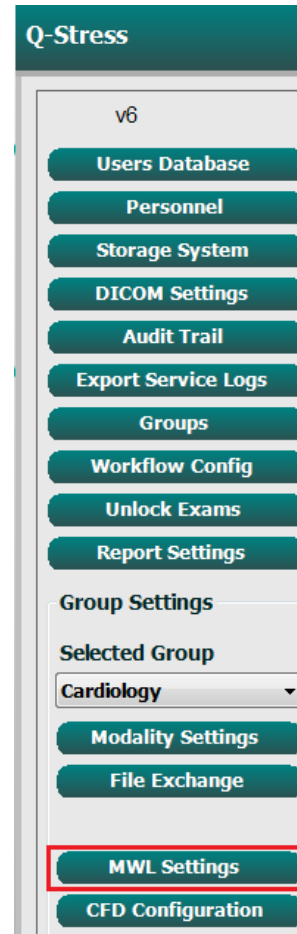

The MWL settings are for filtering the MWL items Q-Stress Server seeks from the MWL SCP.

Since these are global settings for all MWL items for all the Q-Stress associated with this Q-Stress Server, the query needs to be fairly broad.

The only settings that specify which MWL items go to the individual Q-Stress workstations are the Requested Procedure Description Lists. There you will list the procedure descriptions for the procedures those particular workstations support.

Setting	DICOM Tag	Description
Modality	(0008,0060)	Usually set to "ECG".
Institution Name	(0008,0080)	Name of institution or department where the order was placed, or where it should be performed.
Scheduled Station Name	(0040,0010)	DICOM Station Name scheduled to perform the test.
Scheduled Procedure Step Location	(0040,0011)	Location where the test is scheduled to be performed.
Current Patient Location	(0038,0300)	Patient's current location, e.g. a room number for an inpatient.
Requested Procedure Location	(0040,1005)	Location where the test was requested to be performed.
Scheduled Procedure Step ID	(0040,0009)	The procedure step ID of the scheduled procedure.
Scheduled Procedure Step Description	(0040,0007)	The text description of the scheduled procedure step.
Requested Procedure ID	(0040,1001)	The ID of the requested procedure.
Scheduled Station AE Title	(0040,0001)	AE Title of the system scheduled to perform the test.
User Tag, Value		Any tag and value not already supported in the other settings can be configured here.
Scheduled Procedure Start Date (days past)	(0040,0002)	Days prior to today. 0 = all dates, 1 = minimum days past.

Setting	DICOM Tag	Description
Scheduled Procedure Start Date (days future)	(0040,0002)	Days in the future. 0 = all dates, 1 = minimum days future.
Holter Requested Procedure Description List	(0032,1060)	List of requested Holter procedure descriptions, separated by commas.
Resting Requested Procedure Description List	(0032,1060)	List of requested resting ECG procedure descriptions, separated by commas.
Stress Requested Procedure Description List	(0032,1060)	List of requested stress procedure descriptions, separated by commas.
Default Modality		The modality to assume when a MWL item does not have a Requested Procedure Description.

DICOM Events

The table below shows when DICOM transactions are performed.

DICOM Transaction	Q-Stress
Modality Worklist C-FIND	Query made periodically according to "Database Check Interval"
PDF or Waveform C-STORE Storage Commitment	When the State is changed to Signed with the "Finalize Exam Update" dialog.
MPPS IN PROGRESS	Not supported.
MPPS DISCONTINUED	Not supported.
MPPS COMPLETED	After performing a new test and changing the State with the "Finalize Exam Update" dialog.

DICOM Echo

The DICOM communications configuration can be verified with the **DICOM Test Utility** found under **Mortara Modality Manager** menu in the Windows Start menu. To perform a DICOM Echo test, click the "Run Test" button. It will display the status of DICOM Echo tests to the Storage SCP, MWL SCP, and MPPS SCP. Click the "Exit" button when done viewing the results.

File Exchange

When the Modality Manager is configured for XML Connectivity, scheduled test information can be received in XML files, or the user can schedule tests using the Schedule/Order icon on the Q-Stress Desktop. Files are automatically exported when they meet the defined criteria for the Workflow Config Export Status settings.

Files can be manually exported anytime from the "Exam Search" dialog. Search for the test to be exported, highlight it, and click **Export**. This Manual Export is only available for tests that meet the defined criteria for the Workflow Config Export Status settings.

Setting	Description
Import directory	If orders will be sent to Modality Manager as XML files, this is the full path to the folder where the XML files will be placed.
Export directory	Specify the full path to the folder where the XML and PDF files should be placed as each test report is signed.
User Name	This is the name of the Windows domain account to use for writing files into the export folder. If left blank, the default service account will be used to write the files.
Password	The account password that goes with the User Name.
Domain	The name of the domain for the User Name account.
Site Number	This is the UNIPRO "Site Number". It is not used by Q-Stress.

Q-Stress Export Q-Exchange XML (v3.6)

XML Tag	Description
/StressTest	
Q-Stress_Final_Report LCID="1033"UNC	Full pathname of export and archive PDF files
./message_id	Message that is exported with no editing from the system.
./expansion_field_1 through 4	Four miscellaneous fields for customer use.
./order_number	Test requisition number issued by external system
./billing_codes	Three billing code fields for billing purposes
./machine_id	Unique identifier for a particular system
./software version	Software version description
/StressTest/Summary	
./EvIDProductName	Device or product Description
./ EvIDStudyKey	GUID for uniquely identifying the study
./ EvIDPatientLastName	Patient's last name.
./ EvIDPatientFirstName	Patient's first name.
./ EvIDPatientMiddleName	Patient's middle name.
./ EvIDPatientMRN	Patient's permanent identification number
./ EvIDPatientAccount	Patient's account (visit) number
./ EvIDPatientSSN	Patient's social security number.
./ EvIDStudyAcqDateISO	Exam acquisition date in ISO format.
./ EvIDStudyAcqTimeISO	Exam acquisition time in ISO format.
./ EvIDStudyInstitution	Name of Institution.
./ EvIDStudyInstitutionID	Institution number.
./ EvIDStudyDepartment	Institution department.

XML Tag	Description
/ EvIDStudyDepartmentID	Institution department number.
/ EvIDStudyInstitutionAddress1	Institution street address.
/ EvIDStudyInstitutionAddress2	Institution street 2 address.
/ EvIDStudyInstitutionCity	City.
/ EvIDStudyInstitutionState	State.
/ EvIDStudyInstitutionZipCode	Zip Code.
/ EvIDStudyInstitutionZipCountry	Country
/ EvIDStudySite	Study Location at an institution.
/ EvIDStudyAttendingPhysicianEntry	Name of Attending Physician.
/ EvIDStudyReferringPhysicianEntry	Name of Referring Physician
/ EvIDStudyTechnicianEntry	Name of Technician.
/ EvIDPatientDOBISO	Patient's date of birth in ISO format, yyyy-MM-dd.
/ EvIDPatientAge	Patient's age at time of exam.
/ EvIDAgeUnit	Patient's age units.
/ EvIDPatientGender	Patient's gender.
/ EvIDPatientHeightValue	Patient's height at time of exam.
/ EvIDHeightUnit	<ul style="list-style-type: none"> • in = inches • cm = centimeters
/ EvIDPatientWeightValue	Patient's weight at time of exam.
/ EvIDWeightUnit	<ul style="list-style-type: none"> • lbs = pounds • kg = kilograms
/ EvIDPatientAddress1	Patient's home address.
/ EvIDPatientAddress2	Patient's home address 2.
/ EvIDPatientCity	Patient's home city.
/ EvIDPatientState	Patient's home state.
/ EvIDPatientZipCode	Patient's home postal (zip) code.
/ EvIDPatientCountry	Patient's home country.
/ EvIDPatientAddress1Mailing	Patient's home address (mailing). *NS
/ EvIDPatientAddress2Mailing	Patient's home address 2 (mailing) *NS
/ EvIDPatientCityMailing	Patient's home city (mailing). *NS
/ EvIDPatientStateMailing	Patient's home state (mailing). *NS
/ EvIDPatientZipCodeMailing	Patient's home postal (zip) code (mailing). *NS
/ EvIDPatientCountryMailing	Patient's home country (mailing). *NS
/ EvIDPatientAddress1Office	Patient's home address (office). *NS
/ EvIDPatientAddress2Office	Patient's home address 2 (office). *NS
/ EvIDPatientCityOffice	Patient's home city (office). *NS
/ EvIDPatientStateOffice	Patient's home state (office). *NS
/ EvIDPatientZipCodeOffice	Patient's home postal (zip) code (office). *NS

XML Tag	Description
./ EvIDPatientCountryOffice	Patient's home country (office). *NS
./ EvIDPatientPhone	Patient's home telephone number.
./ EvIDPatientPhoneWork	Patient's work phone number.
./ EvIDPatientMedicationEntry	Patient's medication name(s), repeated up to 12 times. Each name ends at comma followed by dose, rate, method.
./ EvIDStudyTargetRate	Target Heart Rate for study.
./ EvIDStudyMaxPredictedRate	Maximum Predicted Heart Rate.
./ EvIDFinalMaxHR	Maximum Heart Rate from final report.
./ EvIDFinalRestingHR	Resting Heart Rate for study.
./ EvIDFinalMaxSysBP	Maximum Systolic BP from final report.
./ EvIDFinalRestingDiaBP	Resting Diastolic BP for study.
./ EvIDFinalMaxDiaBP	Maximum Diastolic BP from final report.
./ EvIDFinalRestingSysBP	Resting Systolic BP for study.
./ EvIDFinalMaxBPStage	Phase name in which peak Systolic/Diastolic BP occurred. *NS
./ EvIDProtocol	Protocol name at test end.
./ EvIDExerciseDevice	Treadmill, ergometer or pharmacological.
./ EvIDFinalMaxHRxBP	Double Product from final report.
./ EvIDFinalOverallWCSlopeValue	Worst Case ST Slope value. *NS
./ EvIDFinalOverallWCSlopeLead	Worst Case ST Slope lead. *NS
./ EvIDFinalOverallWCLevelValue	Worst Case ST Level value.
./ EvIDFinalOverallWCLevelLead	Worst Case ST Level lead.
./ EvIDFinalTotalExerciseTime	Total exercise time from final report in minutes:seconds.
./ EvIDFinalTotalMETsAchieved	Total METs from final report.
./ EvIDLastProtocolStageAchieved	Last protocol stage achieved.
./ EvIDReasonForTest	Reason for cardiac stress exam.
./ EvIDReasonForEndingTest	Reason for ending the exam.
./ EvIDTestObservation	Symptoms and observations during the exam.
./ EvIDTestConclusion	Stress exam conclusion summary.
./ EvIDExerDevWkldLabel	Ergometer units for workload. *NS
./ EvIDPatientDiagnosisEntry	Entries for patient diagnosis.
./ EvIDPatientProcedureEntry	Entries for procedures.
./ EvIDPatientRestingECGEntry	Entries for resting ECG. *NS
./ EvIDSmoker	Patient's smoking status.
./ EvIDDiabetes	Patient's diabetes status.
./ EvIDExerciseAngina	Duke Treadmill angina index.
./ IDActiveLifeStyle	Indication of patient's lifestyle status. *NS
./ EvIDLDLCholesterol	Indication of patient's LDL cholesterol status. *NS
./ EvIDHDLCholesterol	Indication of patient's HDL cholesterol status. *NS

XML Tag	Description
./ EvIDDukeScore	Duke Treadmill score.
./ EvIDFAIScore	Functional Aerobic Impairment score.
/StressTest/Tabular	
	One Tabular Line per stage. One per line of STAGE SUMMARY of the stress final report. Each line reports values at the end of that stage.
./ EvIDExStage\stage_time\id	Stage for which the events below occurred and the ID for that stage.
./ EvIDComment	Description of the event.
./ EvIDExTotalStageTime	Time within the stage that the events below occurred.
./ EvIDLogCurrentHR	Heart Rate.
./ EvIDLogCurrentBP	BP in mmHg.
./ EvIDLogHRxBP	Double Product.
./ EvIDExTreadmillSpeed unit	Treadmill Speed.
./ EvIDExTreadmillGrade unit	Treadmill Grade.
./ EvIDExErgometer	Ergometer Workload.
./ EvIDSTLevel lead	Lists every lead and its corresponding ST level measurement under each Stage.
./ EvIDSTSlope lead	Lists every lead and its corresponding ST slope measurement under each Stage.

*NS – Indicates this field is not supported.

Q-Stress Data Import Q-Exchange XML (v3.6)

Data Element Name	Description
qs:message_id Data Not Required	Message imported and exported with no editing from Q-Stress system. Used for tracking; xs:string data type; Alphanumeric characters Min character length: 0, Max character length 40
qs:expansion_fiield_1 through 4 Data Not Required	Four miscellaneous fields for customer use. Imported and exported without any editing from Q-Stress. Used for tracking; xs:string data type; Alphanumeric characters Min character length: 0, Max character length 40
qs:order_number Data Not Required	Test Requisition number issued by HIS and needed for test ID in Billing. xs:string data type; Alphanumeric characters Min character length: 0, Max character length 40
qs:billing_code Data Not Required	Bill code field. xs:string data type; Alphanumeric characters Min character length: 0, Max character length 20
qs:patient_last_name Data Not Required	Patient Last Name xs:string data type; Alphanumeric characters Min character length: 1, Max character length 40
qs:patient_first_name Data Not Required	Patient First Name xs:string data type; Alphanumeric characters Min character length: 0, Max character length 40
qs:patient_middle_name Data Not Required	Patient Middle Name xs:string data type; Alphanumeric characters Min character length: 0, Max character length 40
qs:patient_mm Required	Permanent Patient ID xs:string data type Min character length: 1, Max character length 40
qs:patient_gender Data Not Required	MALE, FEMALE, UNKNOWN, UNSPECIFIED xs:string data type Min character length: N/A, Max character length N/A Short Date Format to be configured at the OS to match
qs:patient_birth_date Data Not Required	Patient Date of Birth xs:string data type Min character length: N/A, Max character length N/A Enumeration "MALE", "FEMALE", "UNKNOWN", "UNSPECIFIED"

The following is an example of Q-Exchange V3.6 XML file exported from Q-Stress:

```
<?xml version="1.0" encoding="utf-16"?>
<Q-Stress_Final_Report
UNC="C:\CSImpExp\XmlOutputDir\X^EXMGR^auto^4704IU22_1^8_1148LK12^Anderson^Thomas^Jack^^_20170516081413_20170516082654.pdf
" LCID="1033" xmlns="http://www.quinton.com/qstress/export/V36">
  <message_id>25500x23</message_id>
  <expansion_field_1>string</expansion_field_1>
  <expansion_field_2>string</expansion_field_2>
  <expansion_field_3>string</expansion_field_3>
  <expansion_field_4>string</expansion_field_4>
```

```

<order_number>4704IU22</order_number>
<billing_codes>
  <billing_code>7717$v09</billing_code>
  <billing_code>16362314</billing_code>
  <billing_code>9529e12</billing_code>
</billing_codes>
<machine_id>198313</machine_id>
<software_version>Report Manager6.2.2.52528</software_version>
<Summary>
  <EvIDProductName>Q-Stress Final Report</EvIDProductName>
  <EvIDStudyKey>{1D5EBE9D-082A-434C-BD2B-4BAD0A8F28CB}</EvIDStudyKey>
  <EvIDPatientLastName>Anderson</EvIDPatientLastName>
  <EvIDPatientFirstName>Thomas</EvIDPatientFirstName>
  <EvIDPatientMiddleName>Jack</EvIDPatientMiddleName>
  <EvIDPatientMRN>1148LK12</EvIDPatientMRN>
  <EvIDPatientAccount>11223344</EvIDPatientAccount>
  <EvIDPatientSSN></EvIDPatientSSN>
  <EvIDStudyAcqDateISO>2017-05-16</EvIDStudyAcqDateISO>
  <EvIDStudyAcqTimeISO>08.14.13</EvIDStudyAcqTimeISO>
  <EvIDStudyInstitution>testInstitution</EvIDStudyInstitution>
  <EvIDStudyInstitutionID></EvIDStudyInstitutionID>
  <EvIDStudyDepartment>Yup</EvIDStudyDepartment>
  <EvIDStudyDepartmentID></EvIDStudyDepartmentID>
  <EvIDStudyInstitutionAddress1 />
  <EvIDStudyInstitutionAddress2 />
  <EvIDStudyInstitutionCity />
  <EvIDStudyInstitutionState />
  <EvIDStudyInstitutionZipCode />
  <EvIDStudyInstitutionZipCountry />
  <EvIDStudySite>Room 123</EvIDStudySite>
  <EvIDStudyAttendingPhysicianEntry>Dr. Maier</EvIDStudyAttendingPhysicianEntry>
  <EvIDStudyReferringPhysicianEntry>Dr. Ramirez</EvIDStudyReferringPhysicianEntry>
  <EvIDStudyTechnicianEntry>Jones</EvIDStudyTechnicianEntry>
  <EvIDPatientDOBISO>1964-09-07</EvIDPatientDOBISO>
  <EvIDPatientAge>52</EvIDPatientAge>
  <EvIDAgeUnit>Years</EvIDAgeUnit>
  <EvIDPatientGender>MALE</EvIDPatientGender>
  <EvIDPatientHeightValue>45</EvIDPatientHeightValue>
  <EvIDHeightUnit>in</EvIDHeightUnit>
  <EvIDPatientWeightValue>145</EvIDPatientWeightValue>
  <EvIDWeightUnit>lb</EvIDWeightUnit>
  <EvIDPatientAddress1>1005 My Street</EvIDPatientAddress1>
  <EvIDPatientAddress2 />
  <EvIDPatientCity>Riverside</EvIDPatientCity>
  <EvIDPatientState>Michigan</EvIDPatientState>
  <EvIDPatientZipCode>12482</EvIDPatientZipCode>
  <EvIDPatientCountry>USA</EvIDPatientCountry>
  <EvIDPatientAddress1Mailing />
  <EvIDPatientAddress2Mailing />
  <EvIDPatientCityMailing />
  <EvIDPatientStateMailing />
  <EvIDPatientZipCodeMailing />
  <EvIDPatientCountryMailing />
  <EvIDPatientAddress1Office />
  <EvIDPatientAddress2Office />
  <EvIDPatientCityOffice />
  <EvIDPatientStateOffice />
  <EvIDPatientZipCodeOffice />
  <EvIDPatientCountryOffice />
  <EvIDPatientPhone>913-965-5851</EvIDPatientPhone>
  <EvIDPatientPhoneWork>819-436-9332</EvIDPatientPhoneWork>
  <EvIDPatientMedicationEntry>Aspirin,,,</EvIDPatientMedicationEntry>
  <EvIDStudyTargetRate>139</EvIDStudyTargetRate>
  <EvIDStudyMaxPredictedRate>171</EvIDStudyMaxPredictedRate>
  <EvIDFinalPercentMaxHR>70</EvIDFinalPercentMaxHR>
  <EvIDFinalMaxHR>120</EvIDFinalMaxHR>
  <EvIDFinalRestingHR>60</EvIDFinalRestingHR>
  <EvIDFinalMaxSysBP>126</EvIDFinalMaxSysBP>
  <EvIDFinalRestingSysBP>125</EvIDFinalRestingSysBP>
  <EvIDFinalMaxDiaBP>88</EvIDFinalMaxDiaBP>
  <EvIDFinalRestingDiaBP>82</EvIDFinalRestingDiaBP>
  <EvIDFinalMaxBPStage />
  <EvIDProtocol>Bruce</EvIDProtocol>
  <EvIDExerciseDevice>Treadmill</EvIDExerciseDevice>
  <EvIDFinalMaxHRxBP>7560</EvIDFinalMaxHRxBP>
  <EvIDFinalOverallWCSlopeValue>--</EvIDFinalOverallWCSlopeValue>

```

```

<EvIDFinalOverallWCSlopeLead></EvIDFinalOverallWCSlopeLead>
<EvIDFinalOverallWCLLevelValue>-0.9</EvIDFinalOverallWCLLevelValue>
<EvIDFinalOverallWCLLevelLead>V5</EvIDFinalOverallWCLLevelLead>
<EvIDFinalTotalExerciseTime>07:49</EvIDFinalTotalExerciseTime>
<EvIDFinalMETsAchieved>9.3</EvIDFinalMETsAchieved>
<EvIDLastProtocolStageAchieved>5</EvIDLastProtocolStageAchieved>
<EvIDReasonForTest>Abnormal ECG</EvIDReasonForTest>
<EvIDReasonForEndingTest>Completion of Protocol</EvIDReasonForEndingTest>
<EvIDTestObservation>Shortness of breath</EvIDTestObservation>
<EvIDTestConclusion>The patient was tested using the Bruce protocol for a duration of 07:49 mm:ss and achieved 9.3
METs. A maximum heart rate of 120 bpm with a target predicted heart rate of 86% was obtained at 08:10. A maximum
systolic blood pressure of 126/88 was obtained at 02:40 and a maximum diastolic blood pressure of 126/88 was obtained at
02:40. A maximum ST depression of -0.9 mm in V5 occurred at 00:10. A maximum ST elevation of +0.5 mm in V2 occurred at
00:10. The patient reached target heart rate with appropriate heart rate and blood pressure response to exercise. No
significant ST changes during exercise or recovery. No evidence of ischemia. Normal exercise stress
test.</EvIDTestConclusion>
<EvIDExerDevWkldLabel />
<EvIDPatientDiagnosisEntry>,No issues</EvIDPatientDiagnosisEntry>
<EvIDPatientProcedureEntry>,Stress Test</EvIDPatientProcedureEntry>
<EvIDPatientRestingECGEntry />
<EvIDSmoker>Yes</EvIDSmoker>
<EvIDDiabetes>Yes</EvIDDiabetes>
<EvIDActiveLifeStyle>--</EvIDActiveLifeStyle>
<EvIDTotalCholesterol>--</EvIDTotalCholesterol>
<EvIDLDLCholesterol>--</EvIDLDLCholesterol>
<EvIDHDLCholesterol>--</EvIDHDLCholesterol>
<EvIDExerciseAngina>None</EvIDExerciseAngina>
<EvIDDukeScore>,</EvIDDukeScore>
<EvIDFAIScore>,</EvIDFAIScore>
</Summary>
<Tabular>
<Stage id="REST" stage_time="00:00">
<EvIDExStage>REST</EvIDExStage>
<EvIDComment>rest </EvIDComment>
</Stage>
<Stage id="REST" stage_time="01:16">
<EvIDExStage>REST</EvIDExStage>
<EvIDExTotalStageTime>01:16</EvIDExTotalStageTime>
<EvIDLogCurrentHR>60</EvIDLogCurrentHR>
<EvIDLogCurrentBP>125/82</EvIDLogCurrentBP>
<EvIDLogHRxBP>7500</EvIDLogHRxBP>
<EvIDExTreadmillSpeed unit="MPH">0.0</EvIDExTreadmillSpeed>
<EvIDExTreadmillGrade unit="%">0.0</EvIDExTreadmillGrade>
<EvIDSTLevel lead="I">-0.4</EvIDSTLevel>
<EvIDSTLevel lead="II">-0.5</EvIDSTLevel>
<EvIDSTLevel lead="III">-0.1</EvIDSTLevel>
<EvIDSTLevel lead="aVR">0.3</EvIDSTLevel>
<EvIDSTLevel lead="aVL">-0.2</EvIDSTLevel>
<EvIDSTLevel lead="aVF">-0.3</EvIDSTLevel>
<EvIDSTLevel lead="V1">0.2</EvIDSTLevel>
<EvIDSTLevel lead="V2">0.5</EvIDSTLevel>
<EvIDSTLevel lead="V3">-0.2</EvIDSTLevel>
<EvIDSTLevel lead="V4">-0.6</EvIDSTLevel>
<EvIDSTLevel lead="V5">-0.9</EvIDSTLevel>
<EvIDSTLevel lead="V6">-0.6</EvIDSTLevel>
<EvIDSTSlope lead="I">2</EvIDSTSlope>
<EvIDSTSlope lead="II">3</EvIDSTSlope>
<EvIDSTSlope lead="III">1</EvIDSTSlope>
<EvIDSTSlope lead="aVR">-3</EvIDSTSlope>
<EvIDSTSlope lead="aVL">1</EvIDSTSlope>
<EvIDSTSlope lead="aVF">2</EvIDSTSlope>
<EvIDSTSlope lead="V1">-1</EvIDSTSlope>
<EvIDSTSlope lead="V2">-3</EvIDSTSlope>
<EvIDSTSlope lead="V3">2</EvIDSTSlope>
<EvIDSTSlope lead="V4">3</EvIDSTSlope>
<EvIDSTSlope lead="V5">6</EvIDSTSlope>
<EvIDSTSlope lead="V6">4</EvIDSTSlope>
</Stage>
<Stage id="1" stage_time="01:00">
<EvIDExStage>STAGE 1</EvIDExStage>
<EvIDExTotalStageTime>01:00</EvIDExTotalStageTime>
<EvIDLogCurrentHR>60</EvIDLogCurrentHR>
<EvIDLogCurrentBP>125/82</EvIDLogCurrentBP>
<EvIDLogHRxBP>7500</EvIDLogHRxBP>
<EvIDExTreadmillSpeed unit="MPH">1.7</EvIDExTreadmillSpeed>
<EvIDExTreadmillGrade unit="%">10.0</EvIDExTreadmillGrade>

```

```

<EvIDSTLevel lead="I">-0.4</EvIDSTLevel>
<EvIDSTLevel lead="II">-0.5</EvIDSTLevel>
<EvIDSTLevel lead="III">-0.1</EvIDSTLevel>
<EvIDSTLevel lead="aVR">0.3</EvIDSTLevel>
<EvIDSTLevel lead="aVL">-0.2</EvIDSTLevel>
<EvIDSTLevel lead="aVF">-0.3</EvIDSTLevel>
<EvIDSTLevel lead="V1">0.2</EvIDSTLevel>
<EvIDSTLevel lead="V2">0.5</EvIDSTLevel>
<EvIDSTLevel lead="V3">-0.2</EvIDSTLevel>
<EvIDSTLevel lead="V4">-0.6</EvIDSTLevel>
<EvIDSTLevel lead="V5">-0.9</EvIDSTLevel>
<EvIDSTLevel lead="V6">-0.6</EvIDSTLevel>
<EvIDSTSlope lead="I">2</EvIDSTSlope>
<EvIDSTSlope lead="II">3</EvIDSTSlope>
<EvIDSTSlope lead="III">1</EvIDSTSlope>
<EvIDSTSlope lead="aVR">-3</EvIDSTSlope>
<EvIDSTSlope lead="aVL">1</EvIDSTSlope>
<EvIDSTSlope lead="aVF">2</EvIDSTSlope>
<EvIDSTSlope lead="V1">-1</EvIDSTSlope>
<EvIDSTSlope lead="V2">-3</EvIDSTSlope>
<EvIDSTSlope lead="V3">2</EvIDSTSlope>
<EvIDSTSlope lead="V4">3</EvIDSTSlope>
<EvIDSTSlope lead="V5">6</EvIDSTSlope>
<EvIDSTSlope lead="V6">4</EvIDSTSlope>
</Stage>
<Stage id="1" stage_time="01:45">
  <EvIDComment>Manual Event Record</EvIDComment>
</Stage>
<Stage id="1" stage_time="01:45">
  <EvIDExStage>STAGE 1</EvIDExStage>
  <EvIDExTotalStageTime>01:45</EvIDExTotalStageTime>
  <EvIDLogCurrentHR>60</EvIDLogCurrentHR>
  <EvIDLogCurrentBP>125/82</EvIDLogCurrentBP>
  <EvIDLogHRxBP>7500</EvIDLogHRxBP>
  <EvIDExTreadmillSpeed unit="MPH">1.7</EvIDExTreadmillSpeed>
  <EvIDExTreadmillGrade unit="%">10.0</EvIDExTreadmillGrade>
  <EvIDSTLevel lead="I">-0.4</EvIDSTLevel>
  <EvIDSTLevel lead="II">-0.5</EvIDSTLevel>
  <EvIDSTLevel lead="III">-0.1</EvIDSTLevel>
  <EvIDSTLevel lead="aVR">0.3</EvIDSTLevel>
  <EvIDSTLevel lead="aVL">-0.2</EvIDSTLevel>
  <EvIDSTLevel lead="aVF">-0.3</EvIDSTLevel>
  <EvIDSTLevel lead="V1">0.2</EvIDSTLevel>
  <EvIDSTLevel lead="V2">0.5</EvIDSTLevel>
  <EvIDSTLevel lead="V3">-0.2</EvIDSTLevel>
  <EvIDSTLevel lead="V4">-0.6</EvIDSTLevel>
  <EvIDSTLevel lead="V5">-0.9</EvIDSTLevel>
  <EvIDSTLevel lead="V6">-0.6</EvIDSTLevel>
  <EvIDSTSlope lead="I">2</EvIDSTSlope>
  <EvIDSTSlope lead="II">3</EvIDSTSlope>
  <EvIDSTSlope lead="III">1</EvIDSTSlope>
  <EvIDSTSlope lead="aVR">-3</EvIDSTSlope>
  <EvIDSTSlope lead="aVL">1</EvIDSTSlope>
  <EvIDSTSlope lead="aVF">2</EvIDSTSlope>
  <EvIDSTSlope lead="V1">-1</EvIDSTSlope>
  <EvIDSTSlope lead="V2">-3</EvIDSTSlope>
  <EvIDSTSlope lead="V3">2</EvIDSTSlope>
  <EvIDSTSlope lead="V4">3</EvIDSTSlope>
  <EvIDSTSlope lead="V5">6</EvIDSTSlope>
  <EvIDSTSlope lead="V6">4</EvIDSTSlope>
</Stage>
<Stage id="1" stage_time="02:00">
  <EvIDExStage>STAGE 1</EvIDExStage>
  <EvIDExTotalStageTime>02:00</EvIDExTotalStageTime>
  <EvIDLogCurrentHR>60</EvIDLogCurrentHR>
  <EvIDLogCurrentBP>125/82</EvIDLogCurrentBP>
  <EvIDLogHRxBP>7500</EvIDLogHRxBP>
  <EvIDExTreadmillSpeed unit="MPH">1.7</EvIDExTreadmillSpeed>
  <EvIDExTreadmillGrade unit="%">10.0</EvIDExTreadmillGrade>
  <EvIDSTLevel lead="I">-0.4</EvIDSTLevel>
  <EvIDSTLevel lead="II">-0.5</EvIDSTLevel>
  <EvIDSTLevel lead="III">-0.1</EvIDSTLevel>
  <EvIDSTLevel lead="aVR">0.3</EvIDSTLevel>
  <EvIDSTLevel lead="aVL">-0.2</EvIDSTLevel>
  <EvIDSTLevel lead="aVF">-0.3</EvIDSTLevel>
  <EvIDSTLevel lead="V1">0.2</EvIDSTLevel>

```

```

<EvIDSTLevel lead="V2">0.5</EvIDSTLevel>
<EvIDSTLevel lead="V3">-0.2</EvIDSTLevel>
<EvIDSTLevel lead="V4">-0.6</EvIDSTLevel>
<EvIDSTLevel lead="V5">-0.9</EvIDSTLevel>
<EvIDSTLevel lead="V6">-0.6</EvIDSTLevel>
<EvIDSTSlope lead="I">2</EvIDSTSlope>
<EvIDSTSlope lead="II">3</EvIDSTSlope>
<EvIDSTSlope lead="III">1</EvIDSTSlope>
<EvIDSTSlope lead="aVR">-3</EvIDSTSlope>
<EvIDSTSlope lead="aVL">1</EvIDSTSlope>
<EvIDSTSlope lead="aVF">2</EvIDSTSlope>
<EvIDSTSlope lead="V1">-1</EvIDSTSlope>
<EvIDSTSlope lead="V2">-3</EvIDSTSlope>
<EvIDSTSlope lead="V3">2</EvIDSTSlope>
<EvIDSTSlope lead="V4">3</EvIDSTSlope>
<EvIDSTSlope lead="V5">6</EvIDSTSlope>
<EvIDSTSlope lead="V6">4</EvIDSTSlope>
</Stage>
<Stage id="1" stage_time="03:00">
  <EvIDExStage>STAGE 1</EvIDExStage>
  <EvIDExTotalStageTime>03:00</EvIDExTotalStageTime>
  <EvIDLogCurrentHR>60</EvIDLogCurrentHR>
  <EvIDLogCurrentBP>126/88</EvIDLogCurrentBP>
  <EvIDLogHRxBP>7560</EvIDLogHRxBP>
  <EvIDExTreadmillSpeed unit="MPH">1.7</EvIDExTreadmillSpeed>
  <EvIDExTreadmillGrade unit="%">10.0</EvIDExTreadmillGrade>
  <EvIDSTLevel lead="I">-0.4</EvIDSTLevel>
  <EvIDSTLevel lead="II">-0.5</EvIDSTLevel>
  <EvIDSTLevel lead="III">-0.1</EvIDSTLevel>
  <EvIDSTLevel lead="aVR">0.3</EvIDSTLevel>
  <EvIDSTLevel lead="aVL">-0.2</EvIDSTLevel>
  <EvIDSTLevel lead="aVF">-0.3</EvIDSTLevel>
  <EvIDSTLevel lead="V1">0.2</EvIDSTLevel>
  <EvIDSTLevel lead="V2">0.5</EvIDSTLevel>
  <EvIDSTLevel lead="V3">-0.2</EvIDSTLevel>
  <EvIDSTLevel lead="V4">-0.6</EvIDSTLevel>
  <EvIDSTLevel lead="V5">-0.9</EvIDSTLevel>
  <EvIDSTLevel lead="V6">-0.6</EvIDSTLevel>
  <EvIDSTSlope lead="I">2</EvIDSTSlope>
  <EvIDSTSlope lead="II">3</EvIDSTSlope>
  <EvIDSTSlope lead="III">1</EvIDSTSlope>
  <EvIDSTSlope lead="aVR">-3</EvIDSTSlope>
  <EvIDSTSlope lead="aVL">1</EvIDSTSlope>
  <EvIDSTSlope lead="aVF">2</EvIDSTSlope>
  <EvIDSTSlope lead="V1">-1</EvIDSTSlope>
  <EvIDSTSlope lead="V2">-3</EvIDSTSlope>
  <EvIDSTSlope lead="V3">2</EvIDSTSlope>
  <EvIDSTSlope lead="V4">3</EvIDSTSlope>
  <EvIDSTSlope lead="V5">6</EvIDSTSlope>
  <EvIDSTSlope lead="V6">4</EvIDSTSlope>
</Stage>
<Stage id="2" stage_time="01:00">
  <EvIDExStage>STAGE 2</EvIDExStage>
  <EvIDExTotalStageTime>01:00</EvIDExTotalStageTime>
  <EvIDLogCurrentHR>90</EvIDLogCurrentHR>
  <EvIDLogCurrentBP>126/88</EvIDLogCurrentBP>
  <EvIDLogHRxBP>7560</EvIDLogHRxBP>
  <EvIDExTreadmillSpeed unit="MPH">2.5</EvIDExTreadmillSpeed>
  <EvIDExTreadmillGrade unit="%">12.0</EvIDExTreadmillGrade>
  <EvIDSTLevel lead="I">-0.2</EvIDSTLevel>
  <EvIDSTLevel lead="II">-0.2</EvIDSTLevel>
  <EvIDSTLevel lead="III">-0.1</EvIDSTLevel>
  <EvIDSTLevel lead="aVR">0.1</EvIDSTLevel>
  <EvIDSTLevel lead="aVL">-0.1</EvIDSTLevel>
  <EvIDSTLevel lead="aVF">-0.1</EvIDSTLevel>
  <EvIDSTLevel lead="V1">0.1</EvIDSTLevel>
  <EvIDSTLevel lead="V2">0.2</EvIDSTLevel>
  <EvIDSTLevel lead="V3">-0.2</EvIDSTLevel>
  <EvIDSTLevel lead="V4">-0.3</EvIDSTLevel>
  <EvIDSTLevel lead="V5">-0.4</EvIDSTLevel>
  <EvIDSTLevel lead="V6">-0.3</EvIDSTLevel>
  <EvIDSTSlope lead="I">1</EvIDSTSlope>
  <EvIDSTSlope lead="II">2</EvIDSTSlope>
  <EvIDSTSlope lead="III">1</EvIDSTSlope>
  <EvIDSTSlope lead="aVR">-2</EvIDSTSlope>
  <EvIDSTSlope lead="aVL">0</EvIDSTSlope>

```

```

<EvIDSTSlope lead="aVF">1</EvIDSTSlope>
<EvIDSTSlope lead="V1">-1</EvIDSTSlope>
<EvIDSTSlope lead="V2">-2</EvIDSTSlope>
<EvIDSTSlope lead="V3">1</EvIDSTSlope>
<EvIDSTSlope lead="V4">2</EvIDSTSlope>
<EvIDSTSlope lead="V5">4</EvIDSTSlope>
<EvIDSTSlope lead="V6">2</EvIDSTSlope>
</Stage>
<Stage id="2" stage_time="01:53">
  <EvIDComment>Shortness of Breath</EvIDComment>
</Stage>
<Stage id="2" stage_time="01:53">
  <EvIDExStage>STAGE 2</EvIDExStage>
  <EvIDExTotalStageTime>01:53</EvIDExTotalStageTime>
  <EvIDLogCurrentHR>90</EvIDLogCurrentHR>
  <EvIDLogCurrentBP>126/88</EvIDLogCurrentBP>
  <EvIDLogHRxBP>7560</EvIDLogHRxBP>
  <EvIDExTreadmillSpeed unit="MPH">2.5</EvIDExTreadmillSpeed>
  <EvIDExTreadmillGrade unit="%">12.0</EvIDExTreadmillGrade>
  <EvIDSTLevel lead="I">-0.2</EvIDSTLevel>
  <EvIDSTLevel lead="II">-0.2</EvIDSTLevel>
  <EvIDSTLevel lead="III">-0.1</EvIDSTLevel>
  <EvIDSTLevel lead="aVR">0.1</EvIDSTLevel>
  <EvIDSTLevel lead="aVL">-0.1</EvIDSTLevel>
  <EvIDSTLevel lead="aVF">-0.1</EvIDSTLevel>
  <EvIDSTLevel lead="V1">0.1</EvIDSTLevel>
  <EvIDSTLevel lead="V2">0.2</EvIDSTLevel>
  <EvIDSTLevel lead="V3">-0.2</EvIDSTLevel>
  <EvIDSTLevel lead="V4">-0.3</EvIDSTLevel>
  <EvIDSTLevel lead="V5">-0.4</EvIDSTLevel>
  <EvIDSTLevel lead="V6">-0.3</EvIDSTLevel>
  <EvIDSTSlope lead="I">1</EvIDSTSlope>
  <EvIDSTSlope lead="II">2</EvIDSTSlope>
  <EvIDSTSlope lead="III">1</EvIDSTSlope>
  <EvIDSTSlope lead="aVR">-2</EvIDSTSlope>
  <EvIDSTSlope lead="aVL">0</EvIDSTSlope>
  <EvIDSTSlope lead="aVF">1</EvIDSTSlope>
  <EvIDSTSlope lead="V1">-1</EvIDSTSlope>
  <EvIDSTSlope lead="V2">-2</EvIDSTSlope>
  <EvIDSTSlope lead="V3">1</EvIDSTSlope>
  <EvIDSTSlope lead="V4">2</EvIDSTSlope>
  <EvIDSTSlope lead="V5">4</EvIDSTSlope>
  <EvIDSTSlope lead="V6">2</EvIDSTSlope>
</Stage>
<Stage id="2" stage_time="02:00">
  <EvIDExStage>STAGE 2</EvIDExStage>
  <EvIDExTotalStageTime>02:00</EvIDExTotalStageTime>
  <EvIDLogCurrentHR>90</EvIDLogCurrentHR>
  <EvIDLogCurrentBP>126/88</EvIDLogCurrentBP>
  <EvIDLogHRxBP>7560</EvIDLogHRxBP>
  <EvIDExTreadmillSpeed unit="MPH">2.5</EvIDExTreadmillSpeed>
  <EvIDExTreadmillGrade unit="%">12.0</EvIDExTreadmillGrade>
  <EvIDSTLevel lead="I">-0.2</EvIDSTLevel>
  <EvIDSTLevel lead="II">-0.2</EvIDSTLevel>
  <EvIDSTLevel lead="III">-0.1</EvIDSTLevel>
  <EvIDSTLevel lead="aVR">0.1</EvIDSTLevel>
  <EvIDSTLevel lead="aVL">-0.1</EvIDSTLevel>
  <EvIDSTLevel lead="aVF">-0.1</EvIDSTLevel>
  <EvIDSTLevel lead="V1">0.1</EvIDSTLevel>
  <EvIDSTLevel lead="V2">0.2</EvIDSTLevel>
  <EvIDSTLevel lead="V3">-0.2</EvIDSTLevel>
  <EvIDSTLevel lead="V4">-0.3</EvIDSTLevel>
  <EvIDSTLevel lead="V5">-0.4</EvIDSTLevel>
  <EvIDSTLevel lead="V6">-0.3</EvIDSTLevel>
  <EvIDSTSlope lead="I">1</EvIDSTSlope>
  <EvIDSTSlope lead="II">2</EvIDSTSlope>
  <EvIDSTSlope lead="III">1</EvIDSTSlope>
  <EvIDSTSlope lead="aVR">-2</EvIDSTSlope>
  <EvIDSTSlope lead="aVL">0</EvIDSTSlope>
  <EvIDSTSlope lead="aVF">1</EvIDSTSlope>
  <EvIDSTSlope lead="V1">-1</EvIDSTSlope>
  <EvIDSTSlope lead="V2">-2</EvIDSTSlope>
  <EvIDSTSlope lead="V3">1</EvIDSTSlope>
  <EvIDSTSlope lead="V4">2</EvIDSTSlope>
  <EvIDSTSlope lead="V5">4</EvIDSTSlope>
  <EvIDSTSlope lead="V6">2</EvIDSTSlope>

```

```

</Stage>
<Stage id="2" stage_time="03:00">
  <EvIDExStage>STAGE 2</EvIDExStage>
  <EvIDExTotalStageTime>03:00</EvIDExTotalStageTime>
  <EvIDLogCurrentHR>90</EvIDLogCurrentHR>
  <EvIDLogCurrentBP>126/88</EvIDLogCurrentBP>
  <EvIDLogHRxBP>7560</EvIDLogHRxBP>
  <EvIDExTreadmillSpeed unit="MPH">2.5</EvIDExTreadmillSpeed>
  <EvIDExTreadmillGrade unit="%">12.0</EvIDExTreadmillGrade>
  <EvIDSTLevel lead="I">-0.2</EvIDSTLevel>
  <EvIDSTLevel lead="II">-0.2</EvIDSTLevel>
  <EvIDSTLevel lead="III">-0.1</EvIDSTLevel>
  <EvIDSTLevel lead="aVR">0.1</EvIDSTLevel>
  <EvIDSTLevel lead="aVL">-0.1</EvIDSTLevel>
  <EvIDSTLevel lead="aVF">-0.1</EvIDSTLevel>
  <EvIDSTLevel lead="V1">0.1</EvIDSTLevel>
  <EvIDSTLevel lead="V2">0.2</EvIDSTLevel>
  <EvIDSTLevel lead="V3">-0.2</EvIDSTLevel>
  <EvIDSTLevel lead="V4">-0.3</EvIDSTLevel>
  <EvIDSTLevel lead="V5">-0.4</EvIDSTLevel>
  <EvIDSTLevel lead="V6">-0.3</EvIDSTLevel>
  <EvIDSTSlope lead="I">1</EvIDSTSlope>
  <EvIDSTSlope lead="II">2</EvIDSTSlope>
  <EvIDSTSlope lead="III">0</EvIDSTSlope>
  <EvIDSTSlope lead="aVR">-2</EvIDSTSlope>
  <EvIDSTSlope lead="aVL">1</EvIDSTSlope>
  <EvIDSTSlope lead="aVF">1</EvIDSTSlope>
  <EvIDSTSlope lead="V1">-1</EvIDSTSlope>
  <EvIDSTSlope lead="V2">-2</EvIDSTSlope>
  <EvIDSTSlope lead="V3">1</EvIDSTSlope>
  <EvIDSTSlope lead="V4">2</EvIDSTSlope>
  <EvIDSTSlope lead="V5">4</EvIDSTSlope>
  <EvIDSTSlope lead="V6">2</EvIDSTSlope>
</Stage>
<Stage id="3" stage_time="01:00">
  <EvIDExStage>STAGE 3</EvIDExStage>
  <EvIDExTotalStageTime>01:00</EvIDExTotalStageTime>
  <EvIDLogCurrentHR>119</EvIDLogCurrentHR>
  <EvIDLogCurrentBP>126/88</EvIDLogCurrentBP>
  <EvIDLogHRxBP>7560</EvIDLogHRxBP>
  <EvIDExTreadmillSpeed unit="MPH">3.4</EvIDExTreadmillSpeed>
  <EvIDExTreadmillGrade unit="%">14.0</EvIDExTreadmillGrade>
  <EvIDSTLevel lead="I">-0.1</EvIDSTLevel>
  <EvIDSTLevel lead="II">-0.1</EvIDSTLevel>
  <EvIDSTLevel lead="III">-0.1</EvIDSTLevel>
  <EvIDSTLevel lead="aVR">0.0</EvIDSTLevel>
  <EvIDSTLevel lead="aVL">-0.1</EvIDSTLevel>
  <EvIDSTLevel lead="aVF">-0.1</EvIDSTLevel>
  <EvIDSTLevel lead="V1">0.0</EvIDSTLevel>
  <EvIDSTLevel lead="V2">0.1</EvIDSTLevel>
  <EvIDSTLevel lead="V3">-0.1</EvIDSTLevel>
  <EvIDSTLevel lead="V4">-0.2</EvIDSTLevel>
  <EvIDSTLevel lead="V5">-0.2</EvIDSTLevel>
  <EvIDSTLevel lead="V6">-0.2</EvIDSTLevel>
  <EvIDSTSlope lead="I">14</EvIDSTSlope>
  <EvIDSTSlope lead="II">17</EvIDSTSlope>
  <EvIDSTSlope lead="III">3</EvIDSTSlope>
  <EvIDSTSlope lead="aVR">-15</EvIDSTSlope>
  <EvIDSTSlope lead="aVL">5</EvIDSTSlope>
  <EvIDSTSlope lead="aVF">10</EvIDSTSlope>
  <EvIDSTSlope lead="V1">-10</EvIDSTSlope>
  <EvIDSTSlope lead="V2">-24</EvIDSTSlope>
  <EvIDSTSlope lead="V3">9</EvIDSTSlope>
  <EvIDSTSlope lead="V4">23</EvIDSTSlope>
  <EvIDSTSlope lead="V5">38</EvIDSTSlope>
  <EvIDSTSlope lead="V6">24</EvIDSTSlope>
</Stage>
<Stage id="3" stage_time="01:04">
  <EvIDExStage>STAGE 3</EvIDExStage>
  <EvIDExTotalStageTime>01:04</EvIDExTotalStageTime>
  <EvIDLogCurrentHR>119</EvIDLogCurrentHR>
  <EvIDLogCurrentBP>126/88</EvIDLogCurrentBP>
  <EvIDLogHRxBP>7560</EvIDLogHRxBP>
  <EvIDExTreadmillSpeed unit="MPH">4.2</EvIDExTreadmillSpeed>
  <EvIDExTreadmillGrade unit="%">16.0</EvIDExTreadmillGrade>
  <EvIDSTLevel lead="I">-0.1</EvIDSTLevel>

```



```

<EvIDSTLevel lead="II">-0.1</EvIDSTLevel>
<EvIDSTLevel lead="III">-0.1</EvIDSTLevel>
<EvIDSTLevel lead="aVR">0.0</EvIDSTLevel>
<EvIDSTLevel lead="aVL">-0.1</EvIDSTLevel>
<EvIDSTLevel lead="aVF">-0.1</EvIDSTLevel>
<EvIDSTLevel lead="V1">0.0</EvIDSTLevel>
<EvIDSTLevel lead="V2">0.1</EvIDSTLevel>
<EvIDSTLevel lead="V3">-0.1</EvIDSTLevel>
<EvIDSTLevel lead="V4">-0.2</EvIDSTLevel>
<EvIDSTLevel lead="V5">-0.2</EvIDSTLevel>
<EvIDSTLevel lead="V6">-0.2</EvIDSTLevel>
<EvIDSTSlope lead="I">14</EvIDSTSlope>
<EvIDSTSlope lead="II">17</EvIDSTSlope>
<EvIDSTSlope lead="III">3</EvIDSTSlope>
<EvIDSTSlope lead="aVR">-15</EvIDSTSlope>
<EvIDSTSlope lead="aVL">5</EvIDSTSlope>
<EvIDSTSlope lead="aVF">10</EvIDSTSlope>
<EvIDSTSlope lead="V1">-10</EvIDSTSlope>
<EvIDSTSlope lead="V2">-24</EvIDSTSlope>
<EvIDSTSlope lead="V3">9</EvIDSTSlope>
<EvIDSTSlope lead="V4">23</EvIDSTSlope>
<EvIDSTSlope lead="V5">38</EvIDSTSlope>
<EvIDSTSlope lead="V6">24</EvIDSTSlope>
</Stage>
<Stage id="4" stage_time="00:30">
  <EvIDExStage>STAGE 4</EvIDExStage>
  <EvIDExTotalStageTime>00:30</EvIDExTotalStageTime>
  <EvIDLogCurrentHR>119</EvIDLogCurrentHR>
  <EvIDLogCurrentBP>126/88</EvIDLogCurrentBP>
  <EvIDLogHRxBP>7560</EvIDLogHRxBP>
  <EvIDExTreadmillSpeed unit="MPH">5.0</EvIDExTreadmillSpeed>
  <EvIDExTreadmillGrade unit="%">18.0</EvIDExTreadmillGrade>
  <EvIDSTLevel lead="I">-0.1</EvIDSTLevel>
  <EvIDSTLevel lead="II">-0.1</EvIDSTLevel>
  <EvIDSTLevel lead="III">0.0</EvIDSTLevel>
  <EvIDSTLevel lead="aVR">0.0</EvIDSTLevel>
  <EvIDSTLevel lead="aVL">-0.1</EvIDSTLevel>
  <EvIDSTLevel lead="aVF">-0.1</EvIDSTLevel>
  <EvIDSTLevel lead="V1">0.0</EvIDSTLevel>
  <EvIDSTLevel lead="V2">0.1</EvIDSTLevel>
  <EvIDSTLevel lead="V3">-0.1</EvIDSTLevel>
  <EvIDSTLevel lead="V4">-0.2</EvIDSTLevel>
  <EvIDSTLevel lead="V5">-0.2</EvIDSTLevel>
  <EvIDSTLevel lead="V6">-0.2</EvIDSTLevel>
  <EvIDSTSlope lead="I">14</EvIDSTSlope>
  <EvIDSTSlope lead="II">17</EvIDSTSlope>
  <EvIDSTSlope lead="III">3</EvIDSTSlope>
  <EvIDSTSlope lead="aVR">-16</EvIDSTSlope>
  <EvIDSTSlope lead="aVL">5</EvIDSTSlope>
  <EvIDSTSlope lead="aVF">10</EvIDSTSlope>
  <EvIDSTSlope lead="V1">-10</EvIDSTSlope>
  <EvIDSTSlope lead="V2">-24</EvIDSTSlope>
  <EvIDSTSlope lead="V3">10</EvIDSTSlope>
  <EvIDSTSlope lead="V4">23</EvIDSTSlope>
  <EvIDSTSlope lead="V5">38</EvIDSTSlope>
  <EvIDSTSlope lead="V6">24</EvIDSTSlope>
</Stage>
<Stage id="5" stage_time="00:15">
  <EvIDComment>Peak</EvIDComment>
</Stage>
<Stage id="5" stage_time="00:15">
  <EvIDExStage>STAGE 5</EvIDExStage>
  <EvIDExTotalStageTime>00:15</EvIDExTotalStageTime>
  <EvIDLogCurrentHR>119</EvIDLogCurrentHR>
  <EvIDLogCurrentBP>126/88</EvIDLogCurrentBP>
  <EvIDLogHRxBP>7560</EvIDLogHRxBP>
  <EvIDExTreadmillSpeed unit="MPH">5.0</EvIDExTreadmillSpeed>
  <EvIDExTreadmillGrade unit="%">18.0</EvIDExTreadmillGrade>
  <EvIDSTLevel lead="I">-0.1</EvIDSTLevel>
  <EvIDSTLevel lead="II">-0.1</EvIDSTLevel>
  <EvIDSTLevel lead="III">0.0</EvIDSTLevel>
  <EvIDSTLevel lead="aVR">0.0</EvIDSTLevel>
  <EvIDSTLevel lead="aVL">-0.1</EvIDSTLevel>
  <EvIDSTLevel lead="aVF">-0.1</EvIDSTLevel>
  <EvIDSTLevel lead="V1">0.0</EvIDSTLevel>
  <EvIDSTLevel lead="V2">0.1</EvIDSTLevel>

```

```

<EvIDSTLevel lead="V3">-0.1</EvIDSTLevel>
<EvIDSTLevel lead="V4">-0.2</EvIDSTLevel>
<EvIDSTLevel lead="V5">-0.2</EvIDSTLevel>
<EvIDSTLevel lead="V6">-0.2</EvIDSTLevel>
<EvIDSTSlope lead="I">14</EvIDSTSlope>
<EvIDSTSlope lead="II">17</EvIDSTSlope>
<EvIDSTSlope lead="III">3</EvIDSTSlope>
<EvIDSTSlope lead="aVR">-16</EvIDSTSlope>
<EvIDSTSlope lead="aVL">5</EvIDSTSlope>
<EvIDSTSlope lead="aVF">10</EvIDSTSlope>
<EvIDSTSlope lead="V1">-10</EvIDSTSlope>
<EvIDSTSlope lead="V2">-24</EvIDSTSlope>
<EvIDSTSlope lead="V3">10</EvIDSTSlope>
<EvIDSTSlope lead="V4">23</EvIDSTSlope>
<EvIDSTSlope lead="V5">38</EvIDSTSlope>
<EvIDSTSlope lead="V6">24</EvIDSTSlope>
</Stage>
<Stage id="RECOVERY" stage_time="00:10">
  <EvIDExStage>RECOVERY</EvIDExStage>
  <EvIDExTotalStageTime>00:10</EvIDExTotalStageTime>
  <EvIDLogCurrentHR>119</EvIDLogCurrentHR>
  <EvIDLogCurrentBP>126/88</EvIDLogCurrentBP>
  <EvIDLogHRxBP>7560</EvIDLogHRxBP>
  <EvIDExTreadmillSpeed unit="MPH">1.5</EvIDExTreadmillSpeed>
  <EvIDExTreadmillGrade unit="%">0.0</EvIDExTreadmillGrade>
  <EvIDSTLevel lead="I">-0.1</EvIDSTLevel>
  <EvIDSTLevel lead="II">-0.1</EvIDSTLevel>
  <EvIDSTLevel lead="III">-0.1</EvIDSTLevel>
  <EvIDSTLevel lead="aVR">0.0</EvIDSTLevel>
  <EvIDSTLevel lead="aVL">-0.1</EvIDSTLevel>
  <EvIDSTLevel lead="aVF">-0.1</EvIDSTLevel>
  <EvIDSTLevel lead="V1">0.0</EvIDSTLevel>
  <EvIDSTLevel lead="V2">0.1</EvIDSTLevel>
  <EvIDSTLevel lead="V3">-0.1</EvIDSTLevel>
  <EvIDSTLevel lead="V4">-0.2</EvIDSTLevel>
  <EvIDSTLevel lead="V5">-0.2</EvIDSTLevel>
  <EvIDSTLevel lead="V6">-0.2</EvIDSTLevel>
  <EvIDSTSlope lead="I">14</EvIDSTSlope>
  <EvIDSTSlope lead="II">17</EvIDSTSlope>
  <EvIDSTSlope lead="III">3</EvIDSTSlope>
  <EvIDSTSlope lead="aVR">-16</EvIDSTSlope>
  <EvIDSTSlope lead="aVL">5</EvIDSTSlope>
  <EvIDSTSlope lead="aVF">10</EvIDSTSlope>
  <EvIDSTSlope lead="V1">-10</EvIDSTSlope>
  <EvIDSTSlope lead="V2">-24</EvIDSTSlope>
  <EvIDSTSlope lead="V3">10</EvIDSTSlope>
  <EvIDSTSlope lead="V4">23</EvIDSTSlope>
  <EvIDSTSlope lead="V5">38</EvIDSTSlope>
  <EvIDSTSlope lead="V6">24</EvIDSTSlope>
</Stage>
<Stage id="RECOVERY" stage_time="01:10">
  <EvIDExStage>RECOVERY</EvIDExStage>
  <EvIDExTotalStageTime>01:10</EvIDExTotalStageTime>
  <EvIDLogCurrentHR>90</EvIDLogCurrentHR>
  <EvIDLogCurrentBP>126/88</EvIDLogCurrentBP>
  <EvIDLogHRxBP>7560</EvIDLogHRxBP>
  <EvIDExTreadmillSpeed unit="MPH">1.5</EvIDExTreadmillSpeed>
  <EvIDExTreadmillGrade unit="%">0.0</EvIDExTreadmillGrade>
  <EvIDSTLevel lead="I">-0.1</EvIDSTLevel>
  <EvIDSTLevel lead="II">-0.2</EvIDSTLevel>
  <EvIDSTLevel lead="III">0.0</EvIDSTLevel>
  <EvIDSTLevel lead="aVR">0.0</EvIDSTLevel>
  <EvIDSTLevel lead="aVL">-0.1</EvIDSTLevel>
  <EvIDSTLevel lead="aVF">-0.1</EvIDSTLevel>
  <EvIDSTLevel lead="V1">0.0</EvIDSTLevel>
  <EvIDSTLevel lead="V2">0.1</EvIDSTLevel>
  <EvIDSTLevel lead="V3">-0.1</EvIDSTLevel>
  <EvIDSTLevel lead="V4">-0.2</EvIDSTLevel>
  <EvIDSTLevel lead="V5">-0.3</EvIDSTLevel>
  <EvIDSTLevel lead="V6">-0.2</EvIDSTLevel>
  <EvIDSTSlope lead="I">3</EvIDSTSlope>
  <EvIDSTSlope lead="II">3</EvIDSTSlope>
  <EvIDSTSlope lead="III">1</EvIDSTSlope>
  <EvIDSTSlope lead="aVR">-3</EvIDSTSlope>
  <EvIDSTSlope lead="aVL">1</EvIDSTSlope>
  <EvIDSTSlope lead="aVF">2</EvIDSTSlope>

```

```

<EvIDSTSlope lead="V1">-3</EvIDSTSlope>
<EvIDSTSlope lead="V2">-4</EvIDSTSlope>
<EvIDSTSlope lead="V3">2</EvIDSTSlope>
<EvIDSTSlope lead="V4">3</EvIDSTSlope>
<EvIDSTSlope lead="V5">5</EvIDSTSlope>
<EvIDSTSlope lead="V6">4</EvIDSTSlope>
</Stage>
<Stage id="RECOVERY" stage_time="01:31">
  <EvIDComment>Bookmark-Recovering</EvIDComment>
</Stage>
<Stage id="RECOVERY" stage_time="01:31">
  <EvIDExStage>RECOVERY</EvIDExStage>
  <EvIDExTotalStageTime>01:31</EvIDExTotalStageTime>
  <EvIDLogCurrentHR>90</EvIDLogCurrentHR>
  <EvIDLogCurrentBP>126/88</EvIDLogCurrentBP>
  <EvIDLogHRxBP>7560</EvIDLogHRxBP>
  <EvIDExTreadmillSpeed unit="MPH">1.5</EvIDExTreadmillSpeed>
  <EvIDExTreadmillGrade unit="%">0.0</EvIDExTreadmillGrade>
  <EvIDSTLevel lead="I">-0.2</EvIDSTLevel>
  <EvIDSTLevel lead="II">-0.2</EvIDSTLevel>
  <EvIDSTLevel lead="III">0.0</EvIDSTLevel>
  <EvIDSTLevel lead="aVR">0.0</EvIDSTLevel>
  <EvIDSTLevel lead="aVL">-0.1</EvIDSTLevel>
  <EvIDSTLevel lead="aVF">-0.1</EvIDSTLevel>
  <EvIDSTLevel lead="V1">0.0</EvIDSTLevel>
  <EvIDSTLevel lead="V2">0.1</EvIDSTLevel>
  <EvIDSTLevel lead="V3">-0.1</EvIDSTLevel>
  <EvIDSTLevel lead="V4">-0.2</EvIDSTLevel>
  <EvIDSTLevel lead="V5">-0.3</EvIDSTLevel>
  <EvIDSTLevel lead="V6">-0.2</EvIDSTLevel>
  <EvIDSTSlope lead="I">3</EvIDSTSlope>
  <EvIDSTSlope lead="II">3</EvIDSTSlope>
  <EvIDSTSlope lead="III">1</EvIDSTSlope>
  <EvIDSTSlope lead="aVR">-3</EvIDSTSlope>
  <EvIDSTSlope lead="aVL">1</EvIDSTSlope>
  <EvIDSTSlope lead="aVF">2</EvIDSTSlope>
  <EvIDSTSlope lead="V1">-3</EvIDSTSlope>
  <EvIDSTSlope lead="V2">-4</EvIDSTSlope>
  <EvIDSTSlope lead="V3">2</EvIDSTSlope>
  <EvIDSTSlope lead="V4">3</EvIDSTSlope>
  <EvIDSTSlope lead="V5">5</EvIDSTSlope>
  <EvIDSTSlope lead="V6">4</EvIDSTSlope>
</Stage>
<Stage id="RECOVERY" stage_time="01:45">
  <EvIDExStage>RECOVERY</EvIDExStage>
  <EvIDExTotalStageTime>01:45</EvIDExTotalStageTime>
  <EvIDLogCurrentHR>90</EvIDLogCurrentHR>
  <EvIDLogCurrentBP>126/88</EvIDLogCurrentBP>
  <EvIDLogHRxBP>7560</EvIDLogHRxBP>
  <EvIDExTreadmillSpeed unit="MPH">1.5</EvIDExTreadmillSpeed>
  <EvIDExTreadmillGrade unit="%">0.0</EvIDExTreadmillGrade>
  <EvIDSTLevel lead="I">-0.2</EvIDSTLevel>
  <EvIDSTLevel lead="II">-0.2</EvIDSTLevel>
  <EvIDSTLevel lead="III">0.0</EvIDSTLevel>
  <EvIDSTLevel lead="aVR">0.0</EvIDSTLevel>
  <EvIDSTLevel lead="aVL">-0.1</EvIDSTLevel>
  <EvIDSTLevel lead="aVF">-0.1</EvIDSTLevel>
  <EvIDSTLevel lead="V1">0.0</EvIDSTLevel>
  <EvIDSTLevel lead="V2">0.1</EvIDSTLevel>
  <EvIDSTLevel lead="V3">-0.1</EvIDSTLevel>
  <EvIDSTLevel lead="V4">-0.2</EvIDSTLevel>
  <EvIDSTLevel lead="V5">-0.3</EvIDSTLevel>
  <EvIDSTLevel lead="V6">-0.2</EvIDSTLevel>
  <EvIDSTSlope lead="I">3</EvIDSTSlope>
  <EvIDSTSlope lead="II">3</EvIDSTSlope>
  <EvIDSTSlope lead="III">1</EvIDSTSlope>
  <EvIDSTSlope lead="aVR">-3</EvIDSTSlope>
  <EvIDSTSlope lead="aVL">1</EvIDSTSlope>
  <EvIDSTSlope lead="aVF">2</EvIDSTSlope>
  <EvIDSTSlope lead="V1">-3</EvIDSTSlope>
  <EvIDSTSlope lead="V2">-4</EvIDSTSlope>
  <EvIDSTSlope lead="V3">2</EvIDSTSlope>
  <EvIDSTSlope lead="V4">3</EvIDSTSlope>
  <EvIDSTSlope lead="V5">5</EvIDSTSlope>
  <EvIDSTSlope lead="V6">4</EvIDSTSlope>
</Stage>

```

</Tabular>
</Q-Stress_Final_Report>

Q-Stress Export Welch Allyn XML

XML Tag	Description
/StressTest	
./Manufacturer	Name of manufacturer of the system that produced the report. Always "Welch Allyn, Inc."
./Version	Name and version of the system that produced the report.
./PDF_Path	Full path and filename of the exported report in PDF format.
/StressTest/PatientDemographics	
./LastName/Value	Patient's last name.
./FirstName/Value	Patient's first name.
./MiddleName/Value	Patient's middle name.
./ID/Value	Patient's primary medical record number.
./SecondaryID/Value	Patient's alternate ID. Site-specific use.
./DOB/Value	Patient's date of birth in format displayed to the user.
./DobEx/Value	Patient's date of birth in XML format, yyyy-MM-dd.
./Age/Value	Patient's age at time of exam.
./Age/Units	Always years .
./TargetHR/Value	Target heart rate to be reached in this exam.
./TargetHR/Units	Always BPM (beats per minute).
./Gender/Value	Patient's gender. Values can be: <ul style="list-style-type: none"> • Male • Female • Unknown
./Race/Value	Patient's race, according to the definition in CFD. Factory default choices in English are: <ul style="list-style-type: none"> • Caucasian • Black • Oriental • Hispanic • American Indian • Aleut • Hawaiian • Pacific Islander • Mongolian • Asian
./Height/Value	Patient's height at time of exam.
./Height/Units	<ul style="list-style-type: none"> • in = inches • cm = centimeters
./Weight/Value	Patient's weight at time of exam.
./Weight/Units	<ul style="list-style-type: none"> • lbs = pounds • kg = kilograms
./Address/Value	Patient's home address. House number and street.
./City/Value	Patient's home city
./State/Value	Patient's home state.
./PostalCode/Value	Patient's home postal (zip) code.

XML Tag	Description
./Country/Value	Patient's home country.
./HomePhone/Value	Patient's home phone number.
./WorkPhone/Value	Patient's work phone number.
./ReferringPhysician/Value	Full name of referring physician.
./AttendingPhysician/Value	Full name of the physician attending the exam .
./Authenticator/Value	Full name of the non-legal signer.
./LegalAuthenticator/Value	Full name of the legal signer.
./Smoker/Value	Values can be: <ul style="list-style-type: none"> • Yes • No • Unknown
./Diabetic/Value	Values can be: <ul style="list-style-type: none"> • Yes • No • Unknown
./HistoryOfMI/Value	Values can be: <ul style="list-style-type: none"> • Yes • No • Unknown
./FamilyHistory/Value	Values can be: <ul style="list-style-type: none"> • Yes • No • Unknown
./PriorCABG/Value	Values can be: <ul style="list-style-type: none"> • Yes • No • Unknown
./PriorCath/Value	Values can be: <ul style="list-style-type: none"> • Yes • No • Unknown
./Angina/Value	Values can be: <ul style="list-style-type: none"> • Atypical • Typical • None
./Indications/Line	There is one Line per indication.
./Medications/Line	There is one Line per medication. Free text or selected from the customizable pick list configured in CFD. Factory list is: <ul style="list-style-type: none"> • Antianginal, • Antiarrhythmic, • Anticholesterol, • Anticoagulants, • Antihypertensive, • Antihypotensive, • Aspirin, • Beta Blockers, • Calcium Blockers, • Digoxin, • Diurectics,

XML Tag	Description
	<ul style="list-style-type: none"> Nitroglycerin, Psychotropic
./Notes/Line	There is one Line per note. Free text or selected from the customizable pick list configured in NotesList.txt.
./MessageID/Value	Values carried over from the XML requests.
./OrderNumber/Value	
./BillingCode1/Value	
./BillingCode2/Value	
./BillingCode3/Value	
./ExpansionField1/Value	
./ExpansionField2/Value	
./ExpansionField3/Value	
./ExpansionField4/Value	
./AdmissionID/Value	
./AccessionNumber/Value	
/StressTest/TestSummary	
./Institution/Value	From "Dept. Footer" setting on the Miscellaneous tab of the User Settings.
./Protocol/Value	Name of the stress protocol used. Factory defaults include: <ul style="list-style-type: none"> BRUCE Cycle Modified Bruce Balke Ellestad Naughton Pharmacological Low Ramp Medium Ramp High Ramp Astrand USAF/SAM 2.0 USAF/SAM 3.3 Time Ramp METs Ramp Cycle Time Ramp
./ExamDate/Value	Date of exam, in format displayed to user.
./ExamDateEx/Value	Date of exam, in XML format, yyyy-MM-dd.
./ExamTime/Value	Local time of day when exam began in hh:mm format.
./ExcerciseTime/Value	Total exercise time in h:mm:ss format.
./JPoint/Value	Milliseconds from J-point where ST level is measured.
./JPoint/Unit	Always ms (milliseconds).
./LeadsWith100uV_ST/Value	One Value for every lead having at least 100 uV of ST elevation or depression. Values can be: <ul style="list-style-type: none"> I II III

XML Tag	Description
	<ul style="list-style-type: none"> • aVR • aVL • aVF • V1 • V2 • V3 • V4 • V5 • V6
./PVCs/Value	Total number of PVCs detected during the exam.
./DukeScore/Value	Duke treadmill score when the Bruce exercise protocol is used. Ranges from approximately -57 to 21.
./FAI/Value	Functional Aerobic Impairment score, expressed as a percentage. Two values are given separated by a / slash. The first value listed is for a person with a sedentary lifestyle (does not exercise at least once per week sufficient to perspire) and the second value is for an active person (exercises at least once per week sufficient to perspire).
./MaxSpeed/Value	Maximum treadmill speed during exam. Expressed as a number with units (e.g., "5.0 MPH").
./MaxSpeed/Units	<ul style="list-style-type: none"> • MPH = miles per hour • km/h = kilometers per hour
./MaxGrade/Value	Maximum treadmill grade during exam. Expressed as a number with a percentage sign (e.g., "18.0%").
./MaxGrade/Units	Always %.
./MaxPower/Value	Maximum ergometer power during exam. Expressed as a number.
./MaxPower/Units	Always Watts.
./MaxMets/Value	Maximum METs (estimated metabolic equivalents) achieved during test.
./MaxHR/Value	Maximum heart rate achieved during exam.
./MaxHR/Units	Always BPM (beats per minute).
./MaxSBP/Value	Maximum systolic blood pressure during exam. Expressed as "systolic/diastolic" (e.g. "160/80").
./MaxSBP/SBP	Systolic value.
./MaxSBP/DBP	Diastolic value.
./MaxSBP/Time	Time of measurement, from beginning of the exercise phase. Expressed as h:mm:ss.
./MaxSBP/Units	Always mm Hg (millimeters of mercury).
./MaxDBP/Value	Maximum diastolic blood pressure during exam. Expressed as "systolic/diastolic" (e.g. "160/80").
./MaxDBP/SBP	Systolic value.
./MaxDBP/DBP	Diastolic value.
./MaxDBP/Time	Time of measurement, from beginning of the exercise phase. Expressed as h:mm:ss.
./MaxDBP/Units	Always mm Hg (millimeters of mercury).

XML Tag	Description
./MaxDoubleProduct/Value	Maximum double product (systolic BP * HR) achieved during exam.
./MaxPercentTargetHR/Value	Maximum percentage of target heart rate achieved during exam.
./MaxPercentTargetHR/Unit	Always %.
./MaxST_Elevation/Value	ST level of leading having the most elevation during exam.
./MaxST_Elevation/Units	<ul style="list-style-type: none"> • mm = millimeters • uV = microvolts
./MaxST_Elevation/Lead	Lead having the most ST elevation during the exam.
./MaxST_Elevation/Time	Time elapsed from the beginning of the exam when the maximum ST elevation was measured. Expressed in h:mm:ss format.
./MaxST_Depression/Value	ST level of lead having the most depression during the exam.
./MaxST_Depression/Units	<ul style="list-style-type: none"> • mm = millimeters • uV = microvolts
./MaxST_Depression/Lead	Lead having the most ST depression during the exam.
./MaxST_Depression/Time	Time elapsed from the beginning of the exam when the maximum ST depression was measured. Expressed in h:mm:ss format.
./MaxST_ElevationChange/Value	The amount of change measured in lead having the most positive ST change during the exam.
./MaxST_ElevationChange/Units	<ul style="list-style-type: none"> • mm = millimeters • uV = microvolts
./MaxST_ElevationChange/Lead	Lead having the most positive ST change during the exam.
./MaxST_ElevationChange/Time	Time elapsed from the beginning of the exam when the most positive ST change was measured. Expressed in h:mm:ss format.
./MaxST_DepressionChange/Value	The amount of change measured in lead having the most negative ST change during the exam.
./MaxST_DepressionChange/Unit	<ul style="list-style-type: none"> • mm = millimeters • uV = microvolts
./MaxST_DepressionChange/Lead	Lead having the most negative ST change during the exam.
./MaxST_DepressionChange/Time	Time elapsed from the beginning of the exam when the most negative ST change was measured. Expressed in h:mm:ss format.
./MaxSTHR_Index/Value	The maximum ST/HR index measured during the exam.
./ReasonsForEnd/Line	<p>One Line per reason. Free text or selected from the customizable pick list configured in CFD. Factory default list is:</p> <ul style="list-style-type: none"> • T1 Target HR • T2 Planned Submax • T3 Chest Pain • T4 Ischemic ECG • T5 Fatigue • T6 Arm Pain • T7 Neck Pain • T8 MD Discretion

XML Tag	Description
	<ul style="list-style-type: none"> • T9 Dyspnea Maximum heart rate obtained • T10 Nausea/Headache • T11 Dizziness • T12 Hypotension • T13 Vent Arrhythmia • T14 Atrial Arrhythmia • T15 Claudication • T16 Poor Motivation • T17 Syncope • T18 Completion of Infusion • T19 Completion of Protocol • T20 Other
./Symptoms/Line	One Line per symptom. Free text or selected from the customizable pick list configured in CFD.XML.
./Conclusions/Line	<p>One Line per line of conclusion block. Free text, template, or selected from the customizable acronym list configured in ConclusionsList.txt. Factory default list is:</p> <ul style="list-style-type: none"> • myo ECG finding suggestive of myocardial ischemia • C1 No ST Changes • C2 Min Depr ST (0.5-0.9 mm) • C3 Mod ST Depr (1.0-1.9 mm) • C4 Marked Depr ST (=>2.0 mm) • C5 ST Elevation During Exercise • C6 Non-Diagnostic TW Abn • C7 Cond Defects Appeared • C8 RBBB Appeared • C9 Inadequate BP Resp (<30) • C10 Hypertensive BP Response • C11 Inadequate HR c/w Betablocker • C12 Inadequate HR c/w Low level Exercise • C13 Normal Stress Test • C14 Abnormal Stress Test • C15 No Evidence of Ischemia • C16 Chest Pain did not Occur • C17 Atypical Chest Pain • C18 Typical Angina Occured • C19 Exertional Hypotension • C20 Inappropriate Dyspnea • C21 ECG & Sx Typical of CAD • C22 ECG typical of CAD • C23 Sx Typical of CAD • C24 ECG and Sx Suggest CAD • C25 ECG Suggests CAD • C26 Sx Suggest CAD • C27 Markedly abnormal test c/w Extensive CAD • C28 Equivocal Study • C29 Nondiagnostic Test, Inadequate HR Response • C30 Nondiagnostic test, Pt unable to complete • C31 Nondiagnostic Test, Baseline ST depression • C32 Nondiagnostic Test, Conduction Abnormality • C33 Nondiagnostic, Technically Inadequate

XML Tag	Description
	<ul style="list-style-type: none"> • C34 Baseline ST abnormality increased during Stress • C35 Baseline ST abnormality unchanged during Stress • C36 Report of Radionuclide study attached • C37 Test within normal limits
./Technician/Value	Name of technician performing the stress exam. Free text or selected from the customizable pick list configured in CFD.XML.
./ReviewingPhysician/Value	Full name of physician reviewing the stress report. Free text or selected from the customizable pick list configured in CFD.XML.
/StressTest/SummaryTable	
/StressTest/SummaryTable/StageSummaryLine	One StageSummaryLine per stage. One per line of STAGE SUMMARY section of the stress report. Each line reports values at the end of that stage.
./Stage/Value	Name of stage. Values can be: <ul style="list-style-type: none"> • M-LIKAR = Mason-Likar event during pre-exercise • STANDING = Standing event during pre-exercise • HYPERV = Hyperventilation event during pre-exercise • SUPINE = Supine event during pre-exercise • START EXE = end of pre-exercise phase • STAGE 1 = end of stage 1 • STAGE 2 =end of stage 2 • STAGE n = end of stage n, where n is the stage number • PEAK EXE = time and values of peak exercise before entering the recovery phase • RECOVERY = end of 1 minute of recovery. There can be multiple RECOVERY stages, one per minute. • END REC = end of recovery
./StageTime/Value	Time when stage ended, expressed as time elapsed from beginning of exercise or recovery phase. Format is: <ul style="list-style-type: none"> • PRE-X = pre exercise stage • EXE h:mm:ss = exercise stage • REC h:mm:ss = recovery stage
./Speed/Value	Treadmill speed at end of stage.
./Speed/Unit	<ul style="list-style-type: none"> • MPH = miles per hour • km/h = kilometers per hour
./Power/Value	Ergometer workload at end of stage.
./Power/Unit	Always Watts.
./Grade/Value	Treadmill grade at end of stage.
./Grade/Unit	Always %.
./HR/Value	Heart rate at end of stage.
./HR/Unit	Always BPM (beats per minute).
./SystolicBP/Value	Last measured systolic blood pressure in stage.
./SystolicBP/Unit	Always mm Hg (millimeters of mercury).

XML Tag	Description
./DiastolicBP/Value	Last measured diastolic blood pressure in stage.
./DiastolicBP/Unit	Always mm Hg (millimeters of mercury).
./METS/Value	METs (estimated metabolic equivalents) at end of stage.
./DoubleProduct/Value	Double product (systolic BP * HR) at end of stage.
./ST_Level/Lead_I/Value	ST level at end of stage.
./ST_Level/Lead_I/Unit	<ul style="list-style-type: none"> • mm = millimeters • uV = microvolts
./ST_Level/Lead_II/Value	ST level at end of stage.
./ST_Level/Lead_II/Unit	<ul style="list-style-type: none"> • mm = millimeters • uV = microvolts
./ST_Level/Lead_III/Value	ST level at end of stage.
./ST_Level/Lead_III/Unit	<ul style="list-style-type: none"> • mm = millimeters • uV = microvolts
./ST_Level/Lead_aVR/Value	ST level at end of stage.
./ST_Level/Lead_aVR/Unit	<ul style="list-style-type: none"> • mm = millimeters • uV = microvolts
./ST_Level/Lead_-aVR/Value	ST level at end of stage.
./ST_Level/Lead_-aVR/Unit	<ul style="list-style-type: none"> • mm = millimeters • uV = microvolts
./ST_Level/Lead_aVL/Value	ST level at end of stage.
./ST_Level/Lead_aVL/Unit	<ul style="list-style-type: none"> • mm = millimeters • uV = microvolts
./ST_Level/Lead_aVF/Value	ST level at end of stage.
./ST_Level/Lead_aVF/Unit	<ul style="list-style-type: none"> • mm = millimeters • uV = microvolts
./ST_Level/Lead_V1/Value	ST level at end of stage.
./ST_Level/Lead_V1/Unit	<ul style="list-style-type: none"> • mm = millimeters • uV = microvolts
./ST_Level/Lead_V2/Value	ST level at end of stage.
./ST_Level/Lead_V2/Unit	<ul style="list-style-type: none"> • mm = millimeters • uV = microvolts
./ST_Level/Lead_V3/Value	ST level at end of stage.
./ST_Level/Lead_V3/Unit	<ul style="list-style-type: none"> • mm = millimeters • uV = microvolts
./ST_Level/Lead_V4/Value	ST level at end of stage.
./ST_Level/Lead_V4/Unit	<ul style="list-style-type: none"> • mm = millimeters • uV = microvolts
./ST_Level/Lead_V5/Value	ST level at end of stage.
./ST_Level/Lead_V5/Unit	<ul style="list-style-type: none"> • mm = millimeters • uV = microvolts
./ST_Level/Lead_V6/Value	ST level at end of stage.
./ST_Level/Lead_V6/Unit	<ul style="list-style-type: none"> • mm = millimeters • uV = microvolts
./ST_Slope/Lead_I/Value	Slope of waveform at ST measurement point.

XML Tag	Description
./ST_Slope/Lead_I/Unit	Always mV/s (millivolts per second).
./ST_Slope/Lead_II/Value	Slope of waveform at ST measurement point.
./ST_Slope/Lead_II/Unit	Always mV/s (millivolts per second).
./ST_Slope/Lead_III/Value	Slope of waveform at ST measurement point.
./ST_Slope/Lead_III/Unit	Always mV/s (millivolts per second).
./ST_Slope/Lead_aVR/Value	Slope of waveform at ST measurement point.
./ST_Slope/Lead_aVR/Unit	Always mV/s (millivolts per second).
./ST_Slope/Lead_-aVR/Value	Slope of waveform at ST measurement point.
./ST_Slope/Lead_-aVR/Unit	Always mV/s (millivolts per second).
./ST_Slope/Lead_aVL/Value	Slope of waveform at ST measurement point.
./ST_Slope/Lead_aVL/Unit	Always mV/s (millivolts per second).
./ST_Slope/Lead_aVF/Value	Slope of waveform at ST measurement point.
./ST_Slope/Lead_aVF/Unit	Always mV/s (millivolts per second).
./ST_Slope/Lead_V1/Value	Slope of waveform at ST measurement point.
./ST_Slope/Lead_V1/Unit	Always mV/s (millivolts per second).
./ST_Slope/Lead_V2/Value	Slope of waveform at ST measurement point.
./ST_Slope/Lead_V2/Unit	Always mV/s (millivolts per second).
./ST_Slope/Lead_V3/Value	Slope of waveform at ST measurement point.
./ST_Slope/Lead_V3/Unit	Always mV/s (millivolts per second).
./ST_Slope/Lead_V4/Value	Slope of waveform at ST measurement point.
./ST_Slope/Lead_V4/Unit	Always mV/s (millivolts per second).
./ST_Slope/Lead_V5/Value	Slope of waveform at ST measurement point.
./ST_Slope/Lead_V5/Unit	Always mV/s (millivolts per second).
./ST_Slope/Lead_V6/Value	Slope of waveform at ST measurement point.
./ST_Slope/Lead_V6/Unit	Always mV/s (millivolts per second).
/StressTest/SummaryTable/MinuteSummaryLine	The XML structure of the MinuteSummaryLine is the same as StageSummaryLine described above except for the tags described below. Each MinuteSummaryLine describes the state of the patient at the end of each minute and at manually created events and recorded RPEs.
./Stage/Value	Blank for automatically-created minute lines. Contains the name of the event for manually-created events. If the event is "Shortness of Breath", Q-Stress exports "Short of Breath". For other events, it exports the first 16 characters of the event name. When an RPE is recorded, this is RPE _n , where n is the value on the configured scale of 0-10 or 6-20.

Q-Stress Order XML

XML Tag	Description
/StressRequest	
./Manufacturer	Leave blank.
./Version	Leave blank.
/StressRequest/PatientDemographics	
./LastName/Value	Patient's last name.
./FirstName/Value	Patient's first name.
./MiddleName/Value	Patient's middle name.
./ID/Value	Patient's primary medical record number.
./SecondaryID/Value	Patient's alternate ID. Site-specific use.
./DobEx/Value	Patient's date of birth in XML format, yyyy-MM-dd .
./Age/Value	Patient's age in years, if DOB is unknown. If DOB is known, age will be calculated at the time of the exam.
./Age/Units	Leave blank.
./MaxHR/Value	Leave blank. Calculated by Q-Stress.
./TargetHR/Value	Leave blank. Calculated by Q-Stress.
./TargetWatts/Value	Target workload for tests with the ergometer.
./Gender/Value	Patient's gender. Values can be: <ul style="list-style-type: none"> • Male • Female • Unknown
./Race/Value	Patient's race. Free text. Factory defaults in English are: <ul style="list-style-type: none"> • Caucasian • Afro American • Black • Asian • Hispanic • Indian • Other
./Height/Value	Patient's height.
./Height/Units	<ul style="list-style-type: none"> • in = inches • cm = centimeters
./Weight/Value	Patient's weight.
./Weight/Units	<ul style="list-style-type: none"> • lbs = pounds • kg = kilograms
./Address/Value	Patient's home address. House number and street.
./City/Value	Patient's home city.
./State/Value	Patient's home state.
./PostalCode/Value	Patient's home postal (zip) code.
./Country/Value	Patient's home country.
./HomePhone/Value	Patient's home phone number.
./WorkPhone/Value	Patient's work phone number.
./ReferringPhysician/Value	Full name of referring physician. Free text.
./AttendingPhysician/Value	Full name of the attending physician. Free text.
./Smoker/Value	Values can be: <ul style="list-style-type: none"> • Yes • No

XML Tag	Description
	<ul style="list-style-type: none"> • Unknown
./Diabetic/Value	Values can be: <ul style="list-style-type: none"> • Yes • No • Unknown
./HistoryOfMI/Value	Values can be: <ul style="list-style-type: none"> • Yes • No • Unknown
./FamilyHistory/Value	Values can be: <ul style="list-style-type: none"> • Yes • No • Unknown
./PriorCABG/Value	Values can be: <ul style="list-style-type: none"> • Yes • No • Unknown
./PriorCath/Value	Values can be: <ul style="list-style-type: none"> • Yes • No • Unknown
./Angina/Value	Values can be: <ul style="list-style-type: none"> • Atypical • Typical • None
./Indications/Line	There is one Line per indication. Lines are free text.
./Medications/Line	There is one Line per medication. Lines are free text.
./Notes/Line	There is one Line per note. Lines are free text.
./MessageID/Value	Values can be used to carry information from the stress order to the stress results. None of the values are displayed to the user on the screen or on the report.
./OrderNumber/Value	
./BillingCode1/Value	
./BillingCode2/Value	
./BillingCode3/Value	
./ExpansionField1/Value	
./ExpansionField2/Value	
./ExpansionField3/Value	
./ExpansionField4/Value	
./AdmissionID/Value	
./AccessionNumber/Value	

Q-Stress Export Q-Exchange XML (v1.0)

XML Tag	Description
STRESS REFERENCE DATA	
Q-Stress_Final_Report UNC	Full pathname of export PDF files
STRESS TEST SUMMARY DATA	
EvIDProductName	Device or product description
EvIDPatientFullName	Patient full name
EvIDPatientMRN	Patient ID
EvIDPatientSSN	Patient Social Security Number
EvIDStudyAcqDate	Test Acquisition date
EvIDStudyAcqTime	Test Acquisition time
EvIDStudyDepartment	Name of Dept. where Test Is Taken
EvIDStudyInstitution	Name of Institution
EvIDStudyInstitutionAddress1	Street Address *NS
EvIDStudyInstitutionAddress2	2nd component of Street *NS
EvIDStudyInstitutionCity	City *NS
EvIDStudyInstitutionState	State *NS
EvIDStudyInstitutionZipCode	Zip code *NS
EvIDStudyInstitutionCountry	Country *NS
EvIDStudySite	Study location at an institution
EvIDStudyAttendingPhysicianEntry	Name of Attending Physician
EvIDStudyReferringPhysicianEntry	Name of Referring Physician
EvIDStudyTechnicianEntry	Name of Technician
EvIDPatientBirthdate	Patient Date of Birth
EvIDPatientAge	Patient Age
EvIDPatientGender	Patient gender
EvIDPatientHeight	Patient Height
EvIDPatientWeight	Patient Weight
EvIDPatientAddress1	Patient Home Address (Street)
EvIDPatientAddress2	2nd component of Street
EvIDPatientCity	Patient Home Address (City)
EvIDPatientState	Patient Home Address (State)
EvIDPatientZipCode	Patient Home Address (Zip Code)
EvIDPatientCountry	Patient Home Address (Country)
EvIDPatientAddress1Mailing	Patient Mailing Address (Street) *NS
EvIDPatientAddress2Mailing	2nd component of Street *NS
EvIDPatientCityMailing	Patient Mailing Address (City) *NS
EvIDPatientStateMailing	Patient Mailing Address (State) *NS

XML Tag	Description
EvIDPatientZipCodeMailing	Patient Mailing Address (Zip Code) *NS
EvIDPatientCountryMailing	Patient Mailing Address (Country) *NS
EvIDPatientAddress1Office	Patient Office Address (Street) *NS
EvIDPatientAddress2Office	2nd component of Street *NS
EvIDPatientCityOffice	Patient Office Address (City) *NS
EvIDPatientStateOffice	Patient Office Address (State) *NS
EvIDPatientZipCodeOffice	Patient Office Address (Zip Code) *NS
EvIDPatientCountryOffice	Patient Office Address (Country) *NS
EvIDPatientPhone	Patient Home Telephone Number
EvIDPatientPhoneWork	Patient Work Telephone Number
EvIDPatientMedicationEntry	Patient Medication
EvIDFinalRestingHR	Resting HR for study
EvIDFinalRestingSysBP	Resting Systolic BP
EvIDFinalRestingDiaBP	Resting Diastolic BP
EvIDStudyTargetRate	Target HR for study
EvIDStudyMaxPredictedRate	Maximum Predicted Heart rate
EvIDFinalPercentMaxHR	Percent Max HR of study
EvIDFinalMaxHR	Max HR
EvIDFinalMaxSysBP	Max Systolic BP
EvIDFinalMaxDiaBP	Max Diastolic BP
EvIDProtocol	Protocol name
EvIDFinalMaxHRxBP	Rate Pressure Product
EvIDFinalOverallWCSlope	Worst-case ST Slope Value
EvIDFinalOverallWCLLevel	Worst-case ST Level Value
EvIDFinalTotalExerciseTime	Elapsed time for all exercise stages.
EvIDFinalMETsAchieved	Final METs achieved
EvIDReasonForTest	Reason For Stress Test
EvIDReasonForEndingTest	Reason For Ending Test
EvIDTestObservation	Observations during the test.
EvIDTestConclusion	Stress Test Summary Analysis
EvIDExerDevWkldLabel	Defines what device is creating the workload
EvIDPatientDiagnosisEntry	Patients diagnosis
EvIDPatientProcedureEntry	Patients procedures
EvIDPatientRestingECGEntry	Patients resting ECG statements *NS
STRESS TEST TABULAR HEADER	
EvIDExStage	Name of the stage
EvIDExTotalStageTime	Total time for the stage

XML Tag	Description
EvIDLogCurrentHR	Heart Rate
EvIDLogCurrentER	Ectopic Rate
EvIDLogCurrentBP	BP
EvIDLogHRxBP	HRxBP
EvIDExTreadmillSpeed	Device (Treadmill) Speed
EvIDExTreadmillGrade	Device (Treadmill) Grade
EvIDExErgometerRpm	Device (Ergometer) RPM
EvIDExErgometer Workload	Device (Ergometer) workload
EvIDSTLevel	There will be an entry for every lead
EvIDSTSlope	There will be an entry for every lead
EvIDExerDevSpeed	Defines the exercise device's speed units
EvIDExerDevWkld	Defines the exercise device's workload units
STRESS TEST TABULAR DATA	
EvIDExStage	Name of the stage
EvIDComment	Description of the event or stage.
EvIDExTotalStageTime	Total time for the stage
EvIDLogCurrentHR	Heart Rate
EvIDLogCurrentER	Ectopic Rate *NS
EvIDLogCurrentBP	BP
EvIDLogHRxBP	HRxBP
EvIDExTreadmillSpeed	Device (Treadmill) Speed
EvIDExTreadmillGrade	Device (Treadmill) Grade
EvIDExErgometerRpm	Device (Ergometer) RPM
EvIDExErgometer Workload	Device (Ergometer) workload
EvIDSTLevel	There will be an entry for every lead and it's corresponding to ST level measurement.
EvIDSTSlope	There will be an entry for every lead and it's corresponding to ST slope measurement.
EvIDComment	User Comments *NS

*NS – Indicates this field is not supported.

The following is an example of Q-Exchange V1.0 XML file exported from Q-Stress.

```
<?xml version="1.0" encoding="utf-16"?>
<Q-Stress_Final_Report
UNC="C:\CSImpExp\XmlOutputDir\X^EXMGR^manual^4704IU22_1^8_1148LK12^Anderson^Thomas^Jack^^_20170516081413_20170516084520.p
df" LCID="1033">
<Summary>
  <EvIDProductName>X-Scribe Final Report</EvIDProductName>
  <EvIDPatientFullName>Anderson, Thomas Jack</EvIDPatientFullName>
  <EvIDPatientMRN>1148LK12</EvIDPatientMRN>
  <EvIDPatientSSN></EvIDPatientSSN>
  <EvIDStudyAcqDate>05/16/2017</EvIDStudyAcqDate>
  <EvIDStudyAcqTime>08.14.13 AM</EvIDStudyAcqTime>
  <EvIDStudyDepartment>Yup</EvIDStudyDepartment>

```

```

<EvIDStudyInstitution>testInstitution</EvIDStudyInstitution>
<EvIDStudyInstitutionAddress1 />
<EvIDStudyInstitutionAddress2 />
<EvIDStudyInstitutionCity />
<EvIDStudyInstitutionState />
<EvIDStudyInstitutionZipCode />
<EvIDStudyInstitutionCountry />
<EvIDStudySite>Room 123</EvIDStudySite>
<EvIDStudyAttendingPhysicianEntry>Dr. Maier,,</EvIDStudyAttendingPhysicianEntry>
<EvIDStudyReferringPhysicianEntry>Dr. Ramirez,,</EvIDStudyReferringPhysicianEntry>
<EvIDStudyTechnicianEntry>Jones,,</EvIDStudyTechnicianEntry>
<EvIDPatientBirthdate>09/07/1964</EvIDPatientBirthdate>
<EvIDPatientAge>52</EvIDPatientAge>
<EvIDPatientGender>MALE</EvIDPatientGender>
<EvIDPatientHeight>45 in</EvIDPatientHeight>
<EvIDPatientWeight>145 lb</EvIDPatientWeight>
<EvIDPatientAddress1>1005 My Street</EvIDPatientAddress1>
<EvIDPatientAddress2 />
<EvIDPatientCity>Riverside</EvIDPatientCity>
<EvIDPatientState>Michigan</EvIDPatientState>
<EvIDPatientZipCode>12482</EvIDPatientZipCode>
<EvIDPatientCountry>USA</EvIDPatientCountry>
<EvIDPatientAddress1Mailing />
<EvIDPatientAddress2Mailing />
<EvIDPatientCityMailing />
<EvIDPatientStateMailing />
<EvIDPatientZipCodeMailing />
<EvIDPatientCountryMailing />
<EvIDPatientAddress1Office />
<EvIDPatientAddress2Office />
<EvIDPatientCityOffice />
<EvIDPatientStateOffice />
<EvIDPatientZipCodeOffice />
<EvIDPatientCountryOffice />
<EvIDPatientPhone>913-965-5851</EvIDPatientPhone>
<EvIDPatientPhoneWork>819-436-9332</EvIDPatientPhoneWork>
<EvIDPatientMedicationEntry>Aspirin,,,,,</EvIDPatientMedicationEntry>
<EvIDPatientMedicationEntry />
<EvIDPatientMedicationEntry />
<EvIDPatientMedicationEntry />
<EvIDPatientMedicationEntry />
<EvIDPatientMedicationEntry />
<EvIDPatientMedicationEntry />
<EvIDPatientMedicationEntry />
<EvIDPatientMedicationEntry />
<EvIDPatientMedicationEntry />
<EvIDPatientMedicationEntry />
<EvIDPatientMedicationEntry />
<EvIDPatientMedicationEntry />
<EvIDPatientMedicationEntry />
<EvIDPatientMedicationEntry />
<EvIDPatientMedicationEntry />
<EvIDPatientMedicationEntry />
<EvIDPatientMedicationEntry />
<EvIDPatientMedicationEntry />
<EvIDFinalRestingHR>60</EvIDFinalRestingHR>
<EvIDFinalRestingSysBP>125</EvIDFinalRestingSysBP>
<EvIDFinalRestingDiaBP>82</EvIDFinalRestingDiaBP>
<EvIDStudyTargetRate>139</EvIDStudyTargetRate>
<EvIDStudyMaxPredictedRate>171</EvIDStudyMaxPredictedRate>
<EvIDFinalPercentMaxHR>70</EvIDFinalPercentMaxHR>
<EvIDFinalMaxHR>120</EvIDFinalMaxHR>
<EvIDFinalMaxSysBP>126</EvIDFinalMaxSysBP>
<EvIDFinalMaxDiaBP>88</EvIDFinalMaxDiaBP>
<EvIDProtocol>Bruce</EvIDProtocol>
<EvIDFinalMaxHRxBP>7560</EvIDFinalMaxHRxBP>
<EvIDFinalOverallWCslope>--</EvIDFinalOverallWCslope>
<EvIDFinalOverallWCLLevel>-0.9 V5</EvIDFinalOverallWCLLevel>
<EvIDFinalTotalExerciseTime>07:49</EvIDFinalTotalExerciseTime>
<EvIDFinalMETsAchieved>9.3</EvIDFinalMETsAchieved>
<EvIDReasonForTest>Abnormal ECG</EvIDReasonForTest>
<EvIDReasonForEndingTest>Completion of Protocol</EvIDReasonForEndingTest>
<EvIDTestObservation>Shortness of breath</EvIDTestObservation>
<EvIDTestConclusion>The patient was tested using the Bruce protocol for a duration of 07:49 mm:ss and achieved 9.3
METs. A maximum heart rate of 120 bpm with a target predicted heart rate of 86% was obtained at 08:10. A maximum
systolic blood pressure of 126/88 was obtained at 02:40 and a maximum diastolic blood pressure of 126/88 was obtained at
02:40. A maximum ST depression of -0.9 mm in V5 occurred at 00:10. A maximum ST elevation of +0.5 mm in V2 occurred at
00:10. The patient reached target heart rate with appropriate heart rate and blood pressure response to exercise. No
significant ST changes during exercise or recovery. No evidence of ischemia. Normal exercise stress
test.</EvIDTestConclusion>
<EvIDExerDevWkldLabel>TM Grade</EvIDExerDevWkldLabel>
<EvIDPatientDiagnosisEntry>,No issues</EvIDPatientDiagnosisEntry>
<EvIDPatientDiagnosisEntry />

```

```

<EvIDPatientDiagnosisEntry />
<EvIDPatientDiagnosisEntry />
<EvIDPatientDiagnosisEntry />
<EvIDPatientDiagnosisEntry />
<EvIDPatientDiagnosisEntry />
<EvIDPatientDiagnosisEntry />
<EvIDPatientDiagnosisEntry />
<EvIDPatientDiagnosisEntry />
<EvIDPatientDiagnosisEntry />
<EvIDPatientDiagnosisEntry />
<EvIDPatientDiagnosisEntry />
<EvIDPatientProcedureEntry>Stress Test</EvIDPatientProcedureEntry>
<EvIDPatientProcedureEntry />
<EvIDPatientProcedureEntry />
<EvIDPatientProcedureEntry />
<EvIDPatientProcedureEntry />
<EvIDPatientProcedureEntry />
<EvIDPatientProcedureEntry />
<EvIDPatientProcedureEntry />
<EvIDPatientProcedureEntry />
<EvIDPatientProcedureEntry />
<EvIDPatientProcedureEntry />
<EvIDPatientProcedureEntry />
<EvIDPatientRestingECGEntry />
<EvIDPatientRestingECGEntry />
<EvIDPatientRestingECGEntry />
<EvIDPatientRestingECGEntry />
<EvIDPatientRestingECGEntry />
<EvIDPatientRestingECGEntry />
<EvIDPatientRestingECGEntry />
<EvIDPatientRestingECGEntry />
<EvIDPatientRestingECGEntry />
<EvIDPatientRestingECGEntry />
<EvIDPatientRestingECGEntry />
<EvIDPatientRestingECGEntry />
<EvIDPatientRestingECGEntry />
<EvIDPatientRestingECGEntry />
</Summary>
<Tabular>
  <Header>
    <EvIDExStage>Stage</EvIDExStage>
    <EvIDExTotalStageTime>Total Stage Time</EvIDExTotalStageTime>
    <EvIDLogCurrentHR>HR</EvIDLogCurrentHR>
    <EvIDLogCurrentER>ER</EvIDLogCurrentER>
    <EvIDLogCurrentBP>BP</EvIDLogCurrentBP>
    <EvIDLogHRxBP>HRxBP</EvIDLogHRxBP>
    <EvIDExTreadmillSpeed>TM Speed</EvIDExTreadmillSpeed>
    <EvIDExTreadmillGrade>TM Grade</EvIDExTreadmillGrade>
    <EvIDSTLevel>LVL I</EvIDSTLevel>
    <EvIDSTLevel>LVL II</EvIDSTLevel>
    <EvIDSTLevel>LVL III</EvIDSTLevel>
    <EvIDSTLevel>LVL aVR</EvIDSTLevel>
    <EvIDSTLevel>LVL aVL</EvIDSTLevel>
    <EvIDSTLevel>LVL aVF</EvIDSTLevel>
    <EvIDSTLevel>LVL V1</EvIDSTLevel>
    <EvIDSTLevel>LVL V2</EvIDSTLevel>
    <EvIDSTLevel>LVL V3</EvIDSTLevel>
    <EvIDSTLevel>LVL V4</EvIDSTLevel>
    <EvIDSTLevel>LVL V5</EvIDSTLevel>
    <EvIDSTLevel>LVL V6</EvIDSTLevel>
    <EvIDSTSlope>SLP I</EvIDSTSlope>
    <EvIDSTSlope>SLP II</EvIDSTSlope>
    <EvIDSTSlope>SLP III</EvIDSTSlope>
    <EvIDSTSlope>SLP aVR</EvIDSTSlope>
    <EvIDSTSlope>SLP aVL</EvIDSTSlope>
    <EvIDSTSlope>SLP aVF</EvIDSTSlope>
    <EvIDSTSlope>SLP V1</EvIDSTSlope>
    <EvIDSTSlope>SLP V2</EvIDSTSlope>
    <EvIDSTSlope>SLP V3</EvIDSTSlope>
    <EvIDSTSlope>SLP V4</EvIDSTSlope>
    <EvIDSTSlope>SLP V5</EvIDSTSlope>
    <EvIDSTSlope>SLP V6</EvIDSTSlope>
    <EvIDExerDevSpeed>MPH</EvIDExerDevSpeed>
    <EvIDExerDevWkId>%</EvIDExerDevWkId>
  </Header>
  <REST>
    <EvIDComment>rest </EvIDComment>
  </REST>
</REST>

```

```

<EvIDExStage>REST</EvIDExStage>
<EvIDExTotalStageTime>01:16</EvIDExTotalStageTime>
<EvIDLogCurrentHR>60</EvIDLogCurrentHR>
<EvIDLogCurrentER>---</EvIDLogCurrentER>
<EvIDLogCurrentBP>125/82</EvIDLogCurrentBP>
<EvIDLogHRxBP>7500</EvIDLogHRxBP>
<EvIDExTreadmillSpeed>0.0</EvIDExTreadmillSpeed>
<EvIDExTreadmillGrade>0.0</EvIDExTreadmillGrade>
<EvIDSTLevel>-0.4</EvIDSTLevel>
<EvIDSTLevel>-0.5</EvIDSTLevel>
<EvIDSTLevel>-0.1</EvIDSTLevel>
<EvIDSTLevel>0.3</EvIDSTLevel>
<EvIDSTLevel>-0.2</EvIDSTLevel>
<EvIDSTLevel>-0.3</EvIDSTLevel>
<EvIDSTLevel>0.2</EvIDSTLevel>
<EvIDSTLevel>0.5</EvIDSTLevel>
<EvIDSTLevel>-0.2</EvIDSTLevel>
<EvIDSTLevel>-0.6</EvIDSTLevel>
<EvIDSTLevel>-0.9</EvIDSTLevel>
<EvIDSTLevel>-0.6</EvIDSTLevel>
<EvIDSTSlope>2</EvIDSTSlope>
<EvIDSTSlope>3</EvIDSTSlope>
<EvIDSTSlope>1</EvIDSTSlope>
<EvIDSTSlope>-3</EvIDSTSlope>
<EvIDSTSlope>1</EvIDSTSlope>
<EvIDSTSlope>2</EvIDSTSlope>
<EvIDSTSlope>-1</EvIDSTSlope>
<EvIDSTSlope>-3</EvIDSTSlope>
<EvIDSTSlope>2</EvIDSTSlope>
<EvIDSTSlope>3</EvIDSTSlope>
<EvIDSTSlope>6</EvIDSTSlope>
<EvIDSTSlope>4</EvIDSTSlope>
</REST>
<Stage_1>
  <EvIDExStage>Stage 1</EvIDExStage>
  <EvIDExTotalStageTime>01:00</EvIDExTotalStageTime>
  <EvIDLogCurrentHR>60</EvIDLogCurrentHR>
  <EvIDLogCurrentER>---</EvIDLogCurrentER>
  <EvIDLogCurrentBP>125/82</EvIDLogCurrentBP>
  <EvIDLogHRxBP>7500</EvIDLogHRxBP>
  <EvIDExTreadmillSpeed>1.7</EvIDExTreadmillSpeed>
  <EvIDExTreadmillGrade>10.0</EvIDExTreadmillGrade>
  <EvIDSTLevel>-0.4</EvIDSTLevel>
  <EvIDSTLevel>-0.5</EvIDSTLevel>
  <EvIDSTLevel>-0.1</EvIDSTLevel>
  <EvIDSTLevel>0.3</EvIDSTLevel>
  <EvIDSTLevel>-0.2</EvIDSTLevel>
  <EvIDSTLevel>-0.3</EvIDSTLevel>
  <EvIDSTLevel>0.2</EvIDSTLevel>
  <EvIDSTLevel>0.5</EvIDSTLevel>
  <EvIDSTLevel>-0.2</EvIDSTLevel>
  <EvIDSTLevel>-0.6</EvIDSTLevel>
  <EvIDSTLevel>-0.9</EvIDSTLevel>
  <EvIDSTLevel>-0.6</EvIDSTLevel>
  <EvIDSTSlope>2</EvIDSTSlope>
  <EvIDSTSlope>3</EvIDSTSlope>
  <EvIDSTSlope>1</EvIDSTSlope>
  <EvIDSTSlope>-3</EvIDSTSlope>
  <EvIDSTSlope>1</EvIDSTSlope>
  <EvIDSTSlope>2</EvIDSTSlope>
  <EvIDSTSlope>-1</EvIDSTSlope>
  <EvIDSTSlope>-3</EvIDSTSlope>
  <EvIDSTSlope>2</EvIDSTSlope>
  <EvIDSTSlope>3</EvIDSTSlope>
  <EvIDSTSlope>6</EvIDSTSlope>
  <EvIDSTSlope>4</EvIDSTSlope>
</Stage_1>
<Stage_1>
  <EvIDComment>Manual Event Record</EvIDComment>
</Stage_1>
<Stage_1>
  <EvIDExTotalStageTime>01:45</EvIDExTotalStageTime>
  <EvIDLogCurrentHR>60</EvIDLogCurrentHR>
  <EvIDLogCurrentER>---</EvIDLogCurrentER>
  <EvIDLogCurrentBP>125/82</EvIDLogCurrentBP>
  <EvIDLogHRxBP>7500</EvIDLogHRxBP>

```

```

<EvIDExTreadmillSpeed>1.7</EvIDExTreadmillSpeed>
<EvIDExTreadmillGrade>10.0</EvIDExTreadmillGrade>
<EvIDSTLevel>-0.4</EvIDSTLevel>
<EvIDSTLevel>-0.5</EvIDSTLevel>
<EvIDSTLevel>-0.1</EvIDSTLevel>
<EvIDSTLevel>0.3</EvIDSTLevel>
<EvIDSTLevel>-0.2</EvIDSTLevel>
<EvIDSTLevel>-0.3</EvIDSTLevel>
<EvIDSTLevel>0.2</EvIDSTLevel>
<EvIDSTLevel>0.5</EvIDSTLevel>
<EvIDSTLevel>-0.2</EvIDSTLevel>
<EvIDSTLevel>-0.6</EvIDSTLevel>
<EvIDSTLevel>-0.9</EvIDSTLevel>
<EvIDSTLevel>-0.6</EvIDSTLevel>
<EvIDSTSlope>2</EvIDSTSlope>
<EvIDSTSlope>3</EvIDSTSlope>
<EvIDSTSlope>1</EvIDSTSlope>
<EvIDSTSlope>-3</EvIDSTSlope>
<EvIDSTSlope>1</EvIDSTSlope>
<EvIDSTSlope>2</EvIDSTSlope>
<EvIDSTSlope>-1</EvIDSTSlope>
<EvIDSTSlope>-3</EvIDSTSlope>
<EvIDSTSlope>2</EvIDSTSlope>
<EvIDSTSlope>3</EvIDSTSlope>
<EvIDSTSlope>6</EvIDSTSlope>
<EvIDSTSlope>4</EvIDSTSlope>
</Stage_1>
<Stage_1>
<EvIDExTotalStageTime>02:00</EvIDExTotalStageTime>
<EvIDLogCurrentHR>60</EvIDLogCurrentHR>
<EvIDLogCurrentER>---</EvIDLogCurrentER>
<EvIDLogCurrentBP>125/82</EvIDLogCurrentBP>
<EvIDLogHRxBP>7500</EvIDLogHRxBP>
<EvIDExTreadmillSpeed>1.7</EvIDExTreadmillSpeed>
<EvIDExTreadmillGrade>10.0</EvIDExTreadmillGrade>
<EvIDSTLevel>-0.4</EvIDSTLevel>
<EvIDSTLevel>-0.5</EvIDSTLevel>
<EvIDSTLevel>-0.1</EvIDSTLevel>
<EvIDSTLevel>0.3</EvIDSTLevel>
<EvIDSTLevel>-0.2</EvIDSTLevel>
<EvIDSTLevel>-0.3</EvIDSTLevel>
<EvIDSTLevel>0.2</EvIDSTLevel>
<EvIDSTLevel>0.5</EvIDSTLevel>
<EvIDSTLevel>-0.2</EvIDSTLevel>
<EvIDSTLevel>-0.6</EvIDSTLevel>
<EvIDSTLevel>-0.9</EvIDSTLevel>
<EvIDSTLevel>-0.6</EvIDSTLevel>
<EvIDSTSlope>2</EvIDSTSlope>
<EvIDSTSlope>3</EvIDSTSlope>
<EvIDSTSlope>1</EvIDSTSlope>
<EvIDSTSlope>-3</EvIDSTSlope>
<EvIDSTSlope>1</EvIDSTSlope>
<EvIDSTSlope>2</EvIDSTSlope>
<EvIDSTSlope>-1</EvIDSTSlope>
<EvIDSTSlope>-3</EvIDSTSlope>
<EvIDSTSlope>2</EvIDSTSlope>
<EvIDSTSlope>3</EvIDSTSlope>
<EvIDSTSlope>6</EvIDSTSlope>
<EvIDSTSlope>4</EvIDSTSlope>
</Stage_1>
<Stage_1>
<EvIDExTotalStageTime>03:00</EvIDExTotalStageTime>
<EvIDLogCurrentHR>60</EvIDLogCurrentHR>
<EvIDLogCurrentER>---</EvIDLogCurrentER>
<EvIDLogCurrentBP>126/88</EvIDLogCurrentBP>
<EvIDLogHRxBP>7560</EvIDLogHRxBP>
<EvIDExTreadmillSpeed>1.7</EvIDExTreadmillSpeed>
<EvIDExTreadmillGrade>10.0</EvIDExTreadmillGrade>
<EvIDSTLevel>-0.4</EvIDSTLevel>
<EvIDSTLevel>-0.5</EvIDSTLevel>
<EvIDSTLevel>-0.1</EvIDSTLevel>
<EvIDSTLevel>0.3</EvIDSTLevel>
<EvIDSTLevel>-0.2</EvIDSTLevel>
<EvIDSTLevel>-0.3</EvIDSTLevel>
<EvIDSTLevel>0.2</EvIDSTLevel>
<EvIDSTLevel>0.5</EvIDSTLevel>

```

```

<EvIDSTLevel>-0.2</EvIDSTLevel>
<EvIDSTLevel>-0.6</EvIDSTLevel>
<EvIDSTLevel>-0.9</EvIDSTLevel>
<EvIDSTLevel>-0.6</EvIDSTLevel>
<EvIDSTSlope>2</EvIDSTSlope>
<EvIDSTSlope>3</EvIDSTSlope>
<EvIDSTSlope>1</EvIDSTSlope>
<EvIDSTSlope>-3</EvIDSTSlope>
<EvIDSTSlope>1</EvIDSTSlope>
<EvIDSTSlope>2</EvIDSTSlope>
<EvIDSTSlope>-1</EvIDSTSlope>
<EvIDSTSlope>-3</EvIDSTSlope>
<EvIDSTSlope>2</EvIDSTSlope>
<EvIDSTSlope>3</EvIDSTSlope>
<EvIDSTSlope>6</EvIDSTSlope>
<EvIDSTSlope>4</EvIDSTSlope>
</Stage_1>
<Stage_2>
  <EvIDExStage>Stage 2</EvIDExStage>
  <EvIDExTotalStageTime>01:00</EvIDExTotalStageTime>
  <EvIDLogCurrentHR>90</EvIDLogCurrentHR>
  <EvIDLogCurrentER>---</EvIDLogCurrentER>
  <EvIDLogCurrentBP>126/88</EvIDLogCurrentBP>
  <EvIDLogHRxBP>7560</EvIDLogHRxBP>
  <EvIDExTreadmillSpeed>2.5</EvIDExTreadmillSpeed>
  <EvIDExTreadmillGrade>12.0</EvIDExTreadmillGrade>
  <EvIDSTLevel>-0.2</EvIDSTLevel>
  <EvIDSTLevel>-0.2</EvIDSTLevel>
  <EvIDSTLevel>-0.1</EvIDSTLevel>
  <EvIDSTLevel>0.1</EvIDSTLevel>
  <EvIDSTLevel>-0.1</EvIDSTLevel>
  <EvIDSTLevel>-0.1</EvIDSTLevel>
  <EvIDSTLevel>0.1</EvIDSTLevel>
  <EvIDSTLevel>0.2</EvIDSTLevel>
  <EvIDSTLevel>-0.2</EvIDSTLevel>
  <EvIDSTLevel>-0.3</EvIDSTLevel>
  <EvIDSTLevel>-0.4</EvIDSTLevel>
  <EvIDSTLevel>-0.3</EvIDSTLevel>
  <EvIDSTSlope>1</EvIDSTSlope>
  <EvIDSTSlope>2</EvIDSTSlope>
  <EvIDSTSlope>1</EvIDSTSlope>
  <EvIDSTSlope>-2</EvIDSTSlope>
  <EvIDSTSlope>0</EvIDSTSlope>
  <EvIDSTSlope>1</EvIDSTSlope>
  <EvIDSTSlope>-1</EvIDSTSlope>
  <EvIDSTSlope>-2</EvIDSTSlope>
  <EvIDSTSlope>1</EvIDSTSlope>
  <EvIDSTSlope>2</EvIDSTSlope>
  <EvIDSTSlope>4</EvIDSTSlope>
  <EvIDSTSlope>2</EvIDSTSlope>
</Stage_2>
<Stage_2>
  <EvIDComment>Shortness of Breath</EvIDComment>
</Stage_2>
<Stage_2>
  <EvIDExTotalStageTime>01:53</EvIDExTotalStageTime>
  <EvIDLogCurrentHR>90</EvIDLogCurrentHR>
  <EvIDLogCurrentER>---</EvIDLogCurrentER>
  <EvIDLogCurrentBP>126/88</EvIDLogCurrentBP>
  <EvIDLogHRxBP>7560</EvIDLogHRxBP>
  <EvIDExTreadmillSpeed>2.5</EvIDExTreadmillSpeed>
  <EvIDExTreadmillGrade>12.0</EvIDExTreadmillGrade>
  <EvIDSTLevel>-0.2</EvIDSTLevel>
  <EvIDSTLevel>-0.2</EvIDSTLevel>
  <EvIDSTLevel>-0.1</EvIDSTLevel>
  <EvIDSTLevel>0.1</EvIDSTLevel>
  <EvIDSTLevel>-0.1</EvIDSTLevel>
  <EvIDSTLevel>-0.1</EvIDSTLevel>
  <EvIDSTLevel>0.1</EvIDSTLevel>
  <EvIDSTLevel>0.2</EvIDSTLevel>
  <EvIDSTLevel>-0.2</EvIDSTLevel>
  <EvIDSTLevel>-0.3</EvIDSTLevel>
  <EvIDSTLevel>-0.4</EvIDSTLevel>
  <EvIDSTLevel>-0.3</EvIDSTLevel>
  <EvIDSTSlope>1</EvIDSTSlope>
  <EvIDSTSlope>2</EvIDSTSlope>

```

```

<EvIDSTSlope>1</EvIDSTSlope>
<EvIDSTSlope>-2</EvIDSTSlope>
<EvIDSTSlope>0</EvIDSTSlope>
<EvIDSTSlope>1</EvIDSTSlope>
<EvIDSTSlope>-1</EvIDSTSlope>
<EvIDSTSlope>-2</EvIDSTSlope>
<EvIDSTSlope>1</EvIDSTSlope>
<EvIDSTSlope>2</EvIDSTSlope>
<EvIDSTSlope>4</EvIDSTSlope>
<EvIDSTSlope>2</EvIDSTSlope>
</Stage_2>
<Stage_2>
  <EvIDExTotalStageTime>02:00</EvIDExTotalStageTime>
  <EvIDLogCurrentHR>90</EvIDLogCurrentHR>
  <EvIDLogCurrentER>---</EvIDLogCurrentER>
  <EvIDLogCurrentBP>126/88</EvIDLogCurrentBP>
  <EvIDLogHRxBP>7560</EvIDLogHRxBP>
  <EvIDExTreadmillSpeed>2.5</EvIDExTreadmillSpeed>
  <EvIDExTreadmillGrade>12.0</EvIDExTreadmillGrade>
  <EvIDSTLevel>-0.2</EvIDSTLevel>
  <EvIDSTLevel>-0.2</EvIDSTLevel>
  <EvIDSTLevel>-0.1</EvIDSTLevel>
  <EvIDSTLevel>0.1</EvIDSTLevel>
  <EvIDSTLevel>-0.1</EvIDSTLevel>
  <EvIDSTLevel>-0.1</EvIDSTLevel>
  <EvIDSTLevel>0.1</EvIDSTLevel>
  <EvIDSTLevel>0.2</EvIDSTLevel>
  <EvIDSTLevel>-0.2</EvIDSTLevel>
  <EvIDSTLevel>-0.3</EvIDSTLevel>
  <EvIDSTLevel>-0.4</EvIDSTLevel>
  <EvIDSTLevel>-0.3</EvIDSTLevel>
  <EvIDSTSlope>1</EvIDSTSlope>
  <EvIDSTSlope>2</EvIDSTSlope>
  <EvIDSTSlope>1</EvIDSTSlope>
  <EvIDSTSlope>-2</EvIDSTSlope>
  <EvIDSTSlope>0</EvIDSTSlope>
  <EvIDSTSlope>1</EvIDSTSlope>
  <EvIDSTSlope>-1</EvIDSTSlope>
  <EvIDSTSlope>-2</EvIDSTSlope>
  <EvIDSTSlope>1</EvIDSTSlope>
  <EvIDSTSlope>2</EvIDSTSlope>
  <EvIDSTSlope>4</EvIDSTSlope>
  <EvIDSTSlope>2</EvIDSTSlope>
</Stage_2>
<Stage_2>
  <EvIDExTotalStageTime>03:00</EvIDExTotalStageTime>
  <EvIDLogCurrentHR>90</EvIDLogCurrentHR>
  <EvIDLogCurrentER>---</EvIDLogCurrentER>
  <EvIDLogCurrentBP>126/88</EvIDLogCurrentBP>
  <EvIDLogHRxBP>7560</EvIDLogHRxBP>
  <EvIDExTreadmillSpeed>2.5</EvIDExTreadmillSpeed>
  <EvIDExTreadmillGrade>12.0</EvIDExTreadmillGrade>
  <EvIDSTLevel>-0.2</EvIDSTLevel>
  <EvIDSTLevel>-0.2</EvIDSTLevel>
  <EvIDSTLevel>-0.1</EvIDSTLevel>
  <EvIDSTLevel>0.1</EvIDSTLevel>
  <EvIDSTLevel>-0.1</EvIDSTLevel>
  <EvIDSTLevel>-0.1</EvIDSTLevel>
  <EvIDSTLevel>0.1</EvIDSTLevel>
  <EvIDSTLevel>0.2</EvIDSTLevel>
  <EvIDSTLevel>-0.2</EvIDSTLevel>
  <EvIDSTLevel>-0.3</EvIDSTLevel>
  <EvIDSTLevel>-0.4</EvIDSTLevel>
  <EvIDSTLevel>-0.3</EvIDSTLevel>
  <EvIDSTSlope>1</EvIDSTSlope>
  <EvIDSTSlope>2</EvIDSTSlope>
  <EvIDSTSlope>0</EvIDSTSlope>
  <EvIDSTSlope>-2</EvIDSTSlope>
  <EvIDSTSlope>1</EvIDSTSlope>
  <EvIDSTSlope>1</EvIDSTSlope>
  <EvIDSTSlope>-1</EvIDSTSlope>
  <EvIDSTSlope>-2</EvIDSTSlope>
  <EvIDSTSlope>1</EvIDSTSlope>
  <EvIDSTSlope>2</EvIDSTSlope>
  <EvIDSTSlope>4</EvIDSTSlope>
  <EvIDSTSlope>2</EvIDSTSlope>

```



```

</Stage_2>
<Stage_3>
  <EvIDExStage>Stage 3</EvIDExStage>
  <EvIDExTotalStageTime>01:00</EvIDExTotalStageTime>
  <EvIDLogCurrentHR>119</EvIDLogCurrentHR>
  <EvIDLogCurrentER>---</EvIDLogCurrentER>
  <EvIDLogCurrentBP>126/88</EvIDLogCurrentBP>
  <EvIDLogHRxBP>7560</EvIDLogHRxBP>
  <EvIDExTreadmillSpeed>3.4</EvIDExTreadmillSpeed>
  <EvIDExTreadmillGrade>14.0</EvIDExTreadmillGrade>
  <EvIDSTLevel>-0.1</EvIDSTLevel>
  <EvIDSTLevel>-0.1</EvIDSTLevel>
  <EvIDSTLevel>-0.1</EvIDSTLevel>
  <EvIDSTLevel>0.0</EvIDSTLevel>
  <EvIDSTLevel>-0.1</EvIDSTLevel>
  <EvIDSTLevel>-0.1</EvIDSTLevel>
  <EvIDSTLevel>0.0</EvIDSTLevel>
  <EvIDSTLevel>0.1</EvIDSTLevel>
  <EvIDSTLevel>-0.1</EvIDSTLevel>
  <EvIDSTLevel>-0.2</EvIDSTLevel>
  <EvIDSTLevel>-0.2</EvIDSTLevel>
  <EvIDSTLevel>-0.2</EvIDSTLevel>
  <EvIDSTSlope>14</EvIDSTSlope>
  <EvIDSTSlope>17</EvIDSTSlope>
  <EvIDSTSlope>3</EvIDSTSlope>
  <EvIDSTSlope>-15</EvIDSTSlope>
  <EvIDSTSlope>5</EvIDSTSlope>
  <EvIDSTSlope>10</EvIDSTSlope>
  <EvIDSTSlope>-10</EvIDSTSlope>
  <EvIDSTSlope>-24</EvIDSTSlope>
  <EvIDSTSlope>9</EvIDSTSlope>
  <EvIDSTSlope>23</EvIDSTSlope>
  <EvIDSTSlope>38</EvIDSTSlope>
  <EvIDSTSlope>24</EvIDSTSlope>
</Stage_3>
<Stage_3>
  <EvIDExTotalStageTime>01:04</EvIDExTotalStageTime>
  <EvIDLogCurrentHR>119</EvIDLogCurrentHR>
  <EvIDLogCurrentER>---</EvIDLogCurrentER>
  <EvIDLogCurrentBP>126/88</EvIDLogCurrentBP>
  <EvIDLogHRxBP>7560</EvIDLogHRxBP>
  <EvIDExTreadmillSpeed>4.2</EvIDExTreadmillSpeed>
  <EvIDExTreadmillGrade>16.0</EvIDExTreadmillGrade>
  <EvIDSTLevel>-0.1</EvIDSTLevel>
  <EvIDSTLevel>-0.1</EvIDSTLevel>
  <EvIDSTLevel>-0.1</EvIDSTLevel>
  <EvIDSTLevel>0.0</EvIDSTLevel>
  <EvIDSTLevel>-0.1</EvIDSTLevel>
  <EvIDSTLevel>-0.1</EvIDSTLevel>
  <EvIDSTLevel>0.0</EvIDSTLevel>
  <EvIDSTLevel>0.1</EvIDSTLevel>
  <EvIDSTLevel>-0.1</EvIDSTLevel>
  <EvIDSTLevel>-0.2</EvIDSTLevel>
  <EvIDSTLevel>-0.2</EvIDSTLevel>
  <EvIDSTLevel>-0.2</EvIDSTLevel>
  <EvIDSTSlope>14</EvIDSTSlope>
  <EvIDSTSlope>17</EvIDSTSlope>
  <EvIDSTSlope>3</EvIDSTSlope>
  <EvIDSTSlope>-15</EvIDSTSlope>
  <EvIDSTSlope>5</EvIDSTSlope>
  <EvIDSTSlope>10</EvIDSTSlope>
  <EvIDSTSlope>-10</EvIDSTSlope>
  <EvIDSTSlope>-24</EvIDSTSlope>
  <EvIDSTSlope>9</EvIDSTSlope>
  <EvIDSTSlope>23</EvIDSTSlope>
  <EvIDSTSlope>38</EvIDSTSlope>
  <EvIDSTSlope>24</EvIDSTSlope>
</Stage_3>
<Stage_4>
  <EvIDExStage>Stage 4</EvIDExStage>
  <EvIDExTotalStageTime>00:30</EvIDExTotalStageTime>
  <EvIDLogCurrentHR>119</EvIDLogCurrentHR>
  <EvIDLogCurrentER>---</EvIDLogCurrentER>
  <EvIDLogCurrentBP>126/88</EvIDLogCurrentBP>
  <EvIDLogHRxBP>7560</EvIDLogHRxBP>
  <EvIDExTreadmillSpeed>5.0</EvIDExTreadmillSpeed>

```

```

<EvIDExTreadmillGrade>18.0</EvIDExTreadmillGrade>
<EvIDSTLevel>-0.1</EvIDSTLevel>
<EvIDSTLevel>-0.1</EvIDSTLevel>
<EvIDSTLevel>0.0</EvIDSTLevel>
<EvIDSTLevel>0.0</EvIDSTLevel>
<EvIDSTLevel>-0.1</EvIDSTLevel>
<EvIDSTLevel>-0.1</EvIDSTLevel>
<EvIDSTLevel>0.0</EvIDSTLevel>
<EvIDSTLevel>0.1</EvIDSTLevel>
<EvIDSTLevel>-0.1</EvIDSTLevel>
<EvIDSTLevel>-0.2</EvIDSTLevel>
<EvIDSTLevel>-0.2</EvIDSTLevel>
<EvIDSTLevel>-0.2</EvIDSTLevel>
<EvIDSTLevel>-0.2</EvIDSTLevel>
<EvIDSTSlope>14</EvIDSTSlope>
<EvIDSTSlope>17</EvIDSTSlope>
<EvIDSTSlope>3</EvIDSTSlope>
<EvIDSTSlope>-16</EvIDSTSlope>
<EvIDSTSlope>5</EvIDSTSlope>
<EvIDSTSlope>10</EvIDSTSlope>
<EvIDSTSlope>-10</EvIDSTSlope>
<EvIDSTSlope>-24</EvIDSTSlope>
<EvIDSTSlope>10</EvIDSTSlope>
<EvIDSTSlope>23</EvIDSTSlope>
<EvIDSTSlope>38</EvIDSTSlope>
<EvIDSTSlope>24</EvIDSTSlope>
</Stage_4>
<Stage_5>
  <EvIDComment>Peak</EvIDComment>
</Stage_5>
<Stage_5>
  <EvIDExStage>Stage 5</EvIDExStage>
  <EvIDExTotalStageTime>00:15</EvIDExTotalStageTime>
  <EvIDLogCurrentHR>119</EvIDLogCurrentHR>
  <EvIDLogCurrentER>---</EvIDLogCurrentER>
  <EvIDLogCurrentBP>126/88</EvIDLogCurrentBP>
  <EvIDLogHRxBP>7560</EvIDLogHRxBP>
  <EvIDExTreadmillSpeed>5.0</EvIDExTreadmillSpeed>
  <EvIDExTreadmillGrade>18.0</EvIDExTreadmillGrade>
  <EvIDSTLevel>-0.1</EvIDSTLevel>
  <EvIDSTLevel>-0.1</EvIDSTLevel>
  <EvIDSTLevel>0.0</EvIDSTLevel>
  <EvIDSTLevel>0.0</EvIDSTLevel>
  <EvIDSTLevel>-0.1</EvIDSTLevel>
  <EvIDSTLevel>-0.1</EvIDSTLevel>
  <EvIDSTLevel>0.0</EvIDSTLevel>
  <EvIDSTLevel>0.1</EvIDSTLevel>
  <EvIDSTLevel>-0.1</EvIDSTLevel>
  <EvIDSTLevel>-0.2</EvIDSTLevel>
  <EvIDSTLevel>-0.2</EvIDSTLevel>
  <EvIDSTLevel>-0.2</EvIDSTLevel>
  <EvIDSTSlope>14</EvIDSTSlope>
  <EvIDSTSlope>17</EvIDSTSlope>
  <EvIDSTSlope>3</EvIDSTSlope>
  <EvIDSTSlope>-16</EvIDSTSlope>
  <EvIDSTSlope>5</EvIDSTSlope>
  <EvIDSTSlope>10</EvIDSTSlope>
  <EvIDSTSlope>-10</EvIDSTSlope>
  <EvIDSTSlope>-24</EvIDSTSlope>
  <EvIDSTSlope>10</EvIDSTSlope>
  <EvIDSTSlope>23</EvIDSTSlope>
  <EvIDSTSlope>38</EvIDSTSlope>
  <EvIDSTSlope>24</EvIDSTSlope>
</Stage_5>
<RECOVERY>
  <EvIDExStage>RECOVERY</EvIDExStage>
  <EvIDExTotalStageTime>00:10</EvIDExTotalStageTime>
  <EvIDLogCurrentHR>119</EvIDLogCurrentHR>
  <EvIDLogCurrentER>---</EvIDLogCurrentER>
  <EvIDLogCurrentBP>126/88</EvIDLogCurrentBP>
  <EvIDLogHRxBP>7560</EvIDLogHRxBP>
  <EvIDExTreadmillSpeed>1.5</EvIDExTreadmillSpeed>
  <EvIDExTreadmillGrade>0.0</EvIDExTreadmillGrade>
  <EvIDSTLevel>-0.1</EvIDSTLevel>
  <EvIDSTLevel>-0.1</EvIDSTLevel>
  <EvIDSTLevel>-0.1</EvIDSTLevel>
  <EvIDSTLevel>0.0</EvIDSTLevel>

```

```

<EvIDSTLevel>-0.1</EvIDSTLevel>
<EvIDSTLevel>-0.1</EvIDSTLevel>
<EvIDSTLevel>0.0</EvIDSTLevel>
<EvIDSTLevel>0.1</EvIDSTLevel>
<EvIDSTLevel>-0.1</EvIDSTLevel>
<EvIDSTLevel>-0.2</EvIDSTLevel>
<EvIDSTLevel>-0.2</EvIDSTLevel>
<EvIDSTLevel>-0.2</EvIDSTLevel>
<EvIDSTLevel>-0.2</EvIDSTLevel>
<EvIDSTSlope>14</EvIDSTSlope>
<EvIDSTSlope>17</EvIDSTSlope>
<EvIDSTSlope>3</EvIDSTSlope>
<EvIDSTSlope>-16</EvIDSTSlope>
<EvIDSTSlope>5</EvIDSTSlope>
<EvIDSTSlope>10</EvIDSTSlope>
<EvIDSTSlope>-10</EvIDSTSlope>
<EvIDSTSlope>-24</EvIDSTSlope>
<EvIDSTSlope>10</EvIDSTSlope>
<EvIDSTSlope>23</EvIDSTSlope>
<EvIDSTSlope>38</EvIDSTSlope>
<EvIDSTSlope>24</EvIDSTSlope>
</RECOVERY>
<RECOVERY>
  <EvIDExTotalStageTime>01:10</EvIDExTotalStageTime>
  <EvIDLogCurrentHR>90</EvIDLogCurrentHR>
  <EvIDLogCurrentER>---</EvIDLogCurrentER>
  <EvIDLogCurrentBP>126/88</EvIDLogCurrentBP>
  <EvIDLogHRxBP>7560</EvIDLogHRxBP>
  <EvIDExTreadmillSpeed>1.5</EvIDExTreadmillSpeed>
  <EvIDExTreadmillGrade>0.0</EvIDExTreadmillGrade>
  <EvIDSTLevel>-0.1</EvIDSTLevel>
  <EvIDSTLevel>-0.2</EvIDSTLevel>
  <EvIDSTLevel>0.0</EvIDSTLevel>
  <EvIDSTLevel>0.0</EvIDSTLevel>
  <EvIDSTLevel>-0.1</EvIDSTLevel>
  <EvIDSTLevel>-0.1</EvIDSTLevel>
  <EvIDSTLevel>0.0</EvIDSTLevel>
  <EvIDSTLevel>0.1</EvIDSTLevel>
  <EvIDSTLevel>-0.1</EvIDSTLevel>
  <EvIDSTLevel>-0.2</EvIDSTLevel>
  <EvIDSTLevel>-0.3</EvIDSTLevel>
  <EvIDSTLevel>-0.2</EvIDSTLevel>
  <EvIDSTSlope>3</EvIDSTSlope>
  <EvIDSTSlope>3</EvIDSTSlope>
  <EvIDSTSlope>1</EvIDSTSlope>
  <EvIDSTSlope>-3</EvIDSTSlope>
  <EvIDSTSlope>1</EvIDSTSlope>
  <EvIDSTSlope>2</EvIDSTSlope>
  <EvIDSTSlope>-3</EvIDSTSlope>
  <EvIDSTSlope>-4</EvIDSTSlope>
  <EvIDSTSlope>2</EvIDSTSlope>
  <EvIDSTSlope>3</EvIDSTSlope>
  <EvIDSTSlope>5</EvIDSTSlope>
  <EvIDSTSlope>4</EvIDSTSlope>
</RECOVERY>
<RECOVERY>
  <EvIDComment>Bookmark-Recovering</EvIDComment>
</RECOVERY>
<RECOVERY>
  <EvIDExTotalStageTime>01:31</EvIDExTotalStageTime>
  <EvIDLogCurrentHR>90</EvIDLogCurrentHR>
  <EvIDLogCurrentER>---</EvIDLogCurrentER>
  <EvIDLogCurrentBP>126/88</EvIDLogCurrentBP>
  <EvIDLogHRxBP>7560</EvIDLogHRxBP>
  <EvIDExTreadmillSpeed>1.5</EvIDExTreadmillSpeed>
  <EvIDExTreadmillGrade>0.0</EvIDExTreadmillGrade>
  <EvIDSTLevel>-0.2</EvIDSTLevel>
  <EvIDSTLevel>-0.2</EvIDSTLevel>
  <EvIDSTLevel>0.0</EvIDSTLevel>
  <EvIDSTLevel>0.0</EvIDSTLevel>
  <EvIDSTLevel>-0.1</EvIDSTLevel>
  <EvIDSTLevel>-0.1</EvIDSTLevel>
  <EvIDSTLevel>0.0</EvIDSTLevel>
  <EvIDSTLevel>0.1</EvIDSTLevel>
  <EvIDSTLevel>-0.1</EvIDSTLevel>
  <EvIDSTLevel>-0.2</EvIDSTLevel>
  <EvIDSTLevel>-0.3</EvIDSTLevel>

```

```

<EvIDSTLevel>-0.2</EvIDSTLevel>
<EvIDSTSlope>3</EvIDSTSlope>
<EvIDSTSlope>3</EvIDSTSlope>
<EvIDSTSlope>1</EvIDSTSlope>
<EvIDSTSlope>-3</EvIDSTSlope>
<EvIDSTSlope>1</EvIDSTSlope>
<EvIDSTSlope>2</EvIDSTSlope>
<EvIDSTSlope>-3</EvIDSTSlope>
<EvIDSTSlope>-4</EvIDSTSlope>
<EvIDSTSlope>2</EvIDSTSlope>
<EvIDSTSlope>3</EvIDSTSlope>
<EvIDSTSlope>5</EvIDSTSlope>
<EvIDSTSlope>4</EvIDSTSlope>
</RECOVERY>
<RECOVERY>
<EvIDExTotalStageTime>01:45</EvIDExTotalStageTime>
<EvIDLogCurrentHR>90</EvIDLogCurrentHR>
<EvIDLogCurrentER>---</EvIDLogCurrentER>
<EvIDLogCurrentBP>126/88</EvIDLogCurrentBP>
<EvIDLogHRxBP>7560</EvIDLogHRxBP>
<EvIDExTreadmillSpeed>1.5</EvIDExTreadmillSpeed>
<EvIDExTreadmillGrade>0.0</EvIDExTreadmillGrade>
<EvIDSTLevel>-0.2</EvIDSTLevel>
<EvIDSTLevel>-0.2</EvIDSTLevel>
<EvIDSTLevel>0.0</EvIDSTLevel>
<EvIDSTLevel>0.0</EvIDSTLevel>
<EvIDSTLevel>-0.1</EvIDSTLevel>
<EvIDSTLevel>-0.1</EvIDSTLevel>
<EvIDSTLevel>0.0</EvIDSTLevel>
<EvIDSTLevel>0.1</EvIDSTLevel>
<EvIDSTLevel>-0.1</EvIDSTLevel>
<EvIDSTLevel>-0.2</EvIDSTLevel>
<EvIDSTLevel>-0.3</EvIDSTLevel>
<EvIDSTLevel>-0.2</EvIDSTLevel>
<EvIDSTSlope>3</EvIDSTSlope>
<EvIDSTSlope>3</EvIDSTSlope>
<EvIDSTSlope>1</EvIDSTSlope>
<EvIDSTSlope>-3</EvIDSTSlope>
<EvIDSTSlope>1</EvIDSTSlope>
<EvIDSTSlope>2</EvIDSTSlope>
<EvIDSTSlope>-3</EvIDSTSlope>
<EvIDSTSlope>-4</EvIDSTSlope>
<EvIDSTSlope>2</EvIDSTSlope>
<EvIDSTSlope>3</EvIDSTSlope>
<EvIDSTSlope>5</EvIDSTSlope>
<EvIDSTSlope>4</EvIDSTSlope>
</RECOVERY>
</Tabular>
</Q-Stress_Final_Report>

```

23. Q-STRESS PHYSICIAN'S GUIDE

Q-Stress Signal Analysis

This appendix of the user manual is intended for qualified health care professionals who want to learn more about the Q-Stress cardiac stress testing system methods for analysis. It describes various aspects of the Welch Allyn VERITAS™ algorithm for cardiac stress testing analysis.

The Q-Stress analysis process consists of the following steps and components:

1. Acquiring the raw digital ECG data and then processing and storing the digital ECG data.
2. Beat detection and creation of the dominant QRS template
3. Determination of Normal, ventricular, and paced beat types
4. Resting ECG analysis during the Pre-Exercise phase
5. Identification of dominant QRS change in rhythm
6. ST segment analysis of all 12-leads
7. Arrhythmia detection
8. Cardiac stress testing calculations and algorithms
9. Creation of summary data to provide results reporting

Data Acquisition

The Q-Stress patient cable acquires the ECG signal that is digitized at a sampling rate of 40,000 samples per second per channel by the Q-Stress front end (AM12Q). The AM12Q also provides a mode of operation for measuring the patient electrode impedance. The ECG data is filtered and stored by the Q-Stress system at a sampling rate of 500 samples per second per lead, with a resolution of 2.5 microvolts per LSB. The frequency bandwidth of the ECG signal meets AAMI standard EC11:1991/(R)2001 for diagnostic quality ECG data.

Full Disclosure Display and Storage

Full disclosure of historic ECG data is navigable through use of the Context View from the start of the Pre-exercise phase through Recovery end. A miniature single lead is user defined and can be changed to any of the 12-leads at any time. The Context View area highlight stored ECG events and allows addition of new ECG events as well as deletion of stored events that are not desired.

Post exam review supports full disclosure data navigation beat-by-beat as well as quick display of any event from Pre-exercise to Recovery end by a click on ECG events that occurred during the exam, or by a selection of any point in the trends.

Final Report

Cardiac stress testing results can be reported and exported in PDF, XML, and DICOM formats. The final report pages are numbered sequentially with examples explained in this guide.

Filters

Source Consistency Filter (SCF)

Welch Allyn's patented Source Consistency Filter (SCF) is an exclusive feature used for reducing noise associated with stress testing. Using the morphology learned during the **Pre-exercise** phase or during a **relearn** operation, the SCF distinguishes between noise and the actual signal in each of the 12 leads. This filtering reduces muscle tremor noise, low-frequency and high-frequency noise, and baseline artifact while preserving diagnostic-quality waveforms. No low-pass or high-pass frequency filters are needed.

- SCF provides noise reduction without signal degradation.
- SCF first "learns" the morphology of the patient's ECG to determine the true cardiac signal for consistency in all leads.
- SCF then removes inconsistent signals originating from other sources, such as muscle interference, without affecting the actual ECG.

Each signal is consistent, best seen in the 12x1 format

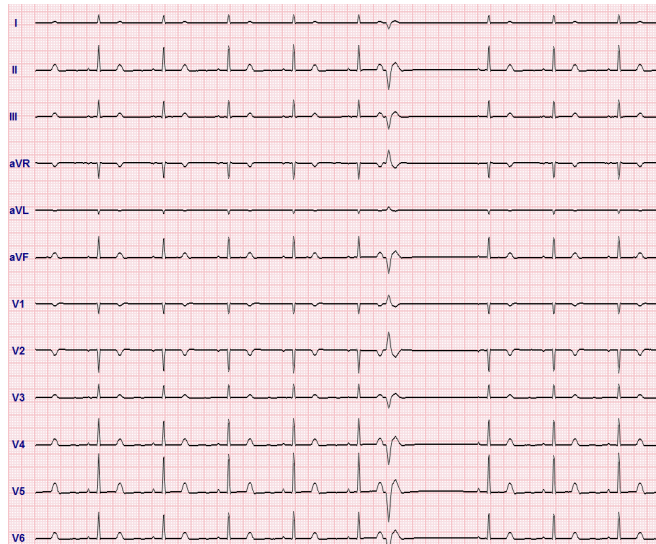

The default state of the filter (enabled or disabled) is determined by the modality settings. When the filter is on, SCF© appears in the lower border of the real-time ECG display. This setting can be changed at any time during a stress exam.

NOTE: When the SCF is enabled, a motionless patient should be maintained in the position that will be assumed during stress testing while the SCF is learning. This will ensure a clean and clear signal during the stress test. A message will appear at the top right-hand side of the display with notification that the SCF filter is in the process of learning. Once this message disappears the SCF has completed its learning process indicating that it's okay for the patient to move.

Beat Consistency Filter (SCF)

The **Beat Consistency Filter (BCF)** provides an averaged ECG printout utilizing the median ECG complexes. Printed lead labels designate 'BCF' next to the lead label (e.g. I BCF, II BCF, III BCF, etc.). The rhythm lead below the 12-lead ECG is real-time and does not reflect the BCF.

NOTE: The BCF introduces an additional two-second delay in the real-time ECG.

Real-time ECG is always displayed on the screen during the exam.

- BCF links averaged ECG to create a noise-free baseline while preserving rhythm and ectopic beats.
- BCF printouts are available in 3x4+1 and 3x4+3 formats with each lead labeled with BCF as defined in the Q-Stress system Modality Settings.
- The rhythm leads in the BCF printout are not beat consistency filtered, representing the true quality of the waveform.

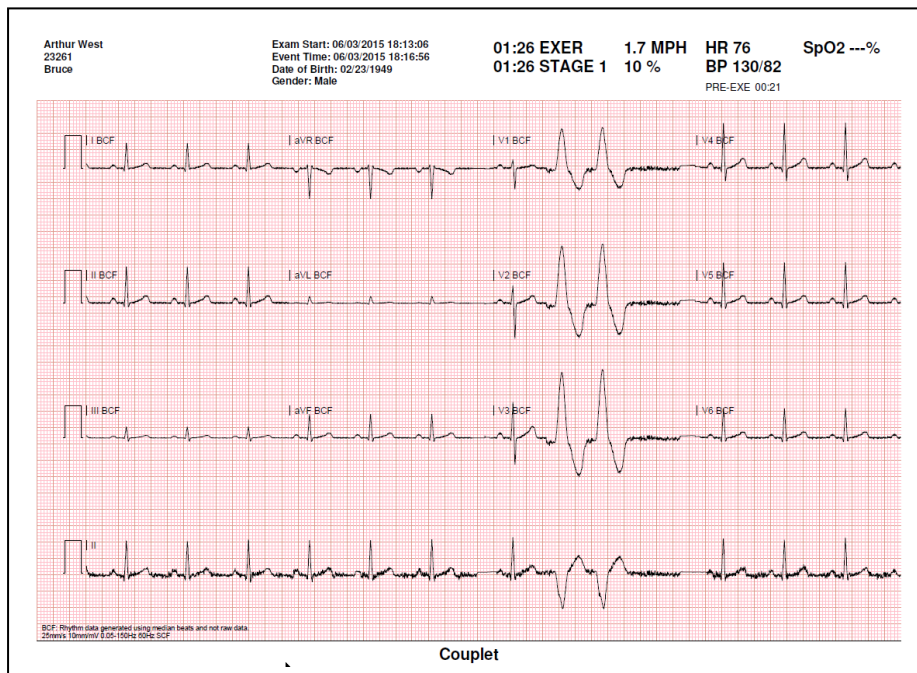

AC Filter (SCF)

The Q-Stress **AC Filter** should always be set to the local power-line frequency at 50 or 60 Hertz. This removes AC 50/60 Hz interference artifact associated with alternating current at the frequency of the mains electricity. When AC interference is present in the trace, 50 or 60 very regular spikes or deflections are observed in 1-second.

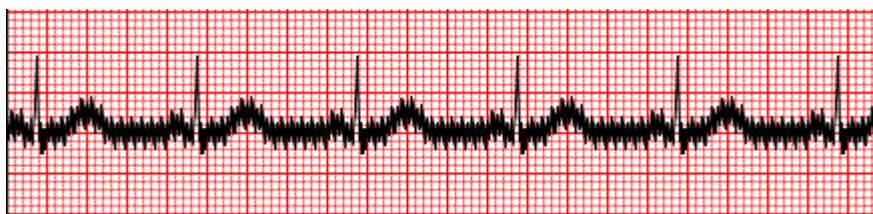

60 Hz AC Interference

40 Hz Filter

The 40 Hz filter is a plot filter, meaning that it affects only the plotted/printed information similar to a 40 Hz filter on an electrocardiograph. The default state of this filter (enabled or disabled) is determined by the selected profile. When the filter is on, 40 Hz appears in the lower border of the real-time ECG display. This filter setting can be toggled between 150 Hz and 40 Hz as needed during a stress test as well as during post-exam review.

It is recommended that the 40 Hz filter is disabled for most exams. This results in a standard ECG filter at 150 Hz. The 40 Hz filter may be used when poor ECG quality causes interpretation difficulties after good electrode to skin preparation has been performed.



WARNING: *When the 40 Hz filter is used, the frequency response requirement for diagnostic ECG equipment cannot be met. The 40 Hz filter significantly reduces high-frequency components of the ECG and pacemaker spike amplitudes, and is recommended only if high-frequency noise cannot be reduced by proper procedures.*

Beat Identification and Accuracy

At the start of a stress exam, Q-Stress initially acquires a dominant QRS complex for each lead to build the first QRS template for all 12 ECG leads. The average QRS waveform for each of the 12 leads is updated after every beat.

If the dominant QRS morphology changes, it is automatically detected and the new morphology is “learned” as the new dominant beat morphology. This event is labeled as DRC (Dominant Rhythm Change) on the displayed trends.

Resting ECG Interpretation

The Q-Stress allows for the acquisition and printing of a baseline supine 12-lead resting ECG with Welch Allyn's VERITAS™ resting ECG interpretation algorithm. A Mason-Likar labeled resting ECG with interpretation may also be performed with torso located leads used for comparison throughout the exam.

For additional information on this algorithm, please refer to the *Physician's Guide to VERITAS with Adult and Pediatric Resting ECG Interpretation*.

Q-Stress Calculations and Algorithms

Heart Rate Calculation

The Q-Stress calculates and displays the HR derived from rhythm leads V1 and V5 with lead II as a confirmation lead using a sliding average window of 16 consecutive R to R intervals.

Q-Stress calculates and displays the current Double Product (DP) value (systolic BP x HR) once a blood pressure is manually or automatically entered. The DP value updates dynamically when the next BP is obtained and is maintained on the display in relation to the BP timestamp.

Displayed and trended heart rate values are averaged over 17 RR intervals that addresses normal physiological increases and decreases in heart rate during exercise. This results in a more gradual response to RR changes and lessens the possibility for false detections that are typically caused by movement artifact.

Analog and TTL signal is output as beat-to-beat triggers for use with external devices that require synchronization pulses.

Estimated Metabolic Equivalents (METs)

The STEADY STATE METs is calculated according to the following formulas:

For Treadmill Protocols –

If (Speed <= 4.0 mph AND Stage Protocol) OR (Ramp Protocol)

$$\text{METs} = 1.0 + 0.8 * \text{Speed} + 0.1375 * \text{Speed} * \% \text{Grade}$$

(Formula for walking)

If (Speed > 4.0 mph AND Stage Protocol)

$$\text{METs} = 1.0 + 1.54 * \text{Speed} + 0.069 * \text{Speed} * \% \text{Grade}$$

(Formula for running)

For Ergometer Protocols –

If (20kg < Weight) AND (Weight < 400kg)

$$\text{METs} = (90.0 + 3.44 * \text{Power}) / \text{Weight}$$

If (Weight <= 20kg) OR (400kg <= Weight)

$$\text{METs} = (90.0 + 3.44 * \text{Power}) / 70$$

The STEADY STATE METs value is not always the value displayed. METs estimation calculation updates every 10 seconds. At each update, the previous actual MET's value is compared with the STEADY STATE value, and will approach the STEADY STATE with no more than 0.3 MET at each calculation. This is done to emulate the gradual change of oxygen uptake in a staged protocol each time the speed and grade or the load changes. Effectively, this method limits the rate of change of the estimated METs to 1.2 MET/minute. In clinically used protocols, the STEADY STATE value will be reached before the end of each stage; for instance with a change of 2.4 METs, it takes 80 seconds into the stage to reach STEADY STATE. However, in some faster changing protocols, such as those used for athletes, the reported estimated METs value may jump if the STEADY STATE has not been achieved. In manual mode, the displayed METs shall update instantaneously as the Speed or Grade is changed.

When viewing the METs, Speed, Grade and Watts in the report summary there are differences in how the values are displayed between the Stage Summary and Minute Summary formats. If the stage changes on the minute, the Stage Summary format will display the Speed, Grade and Watts and maximum METs of that stage. The Minute Summary format will display the values as they appear at that minute, which would be the Speed, Grade and Watts of the next stage.

ST Segment Analysis

When **the Pre-exercise phase is started**, Q-Stress will acquire and analyze the incoming ECG data to develop the dominant beat template. **ST LEARN...** notification is displayed during this process and is replaced by the measured ST level once the dominant template is established.

The ST Profile, when enabled, displays ST value for the on-screen average in a graph format. When the Pre-exercise phase is started, Q-Stress will acquire and analyze the incoming ECG data to develop the current ST level at the beginning of the procedure. The graph displays the current ST levels in black and the reference levels in green.

The ST-segment measurement point can be adjusted and reanalyzed post-exam.

The ST/HR index value is optionally displayed and the value is present only when Q-Stress detects a change in HR with an increase of greater than 10% and ST depression greater than 100 μV . The value is updated every 10-seconds.

Arrhythmia Analysis

The Q-Stress automatically captures and documents ventricular ectopic events such as isolated premature ventricular complexes (PVCs), ventricular couplets, and ventricular runs as arrhythmias.

A dominant rhythm change (DRC) resulting from a change in the dominant QRS configuration is also automatically documented and stored in memory for later review, editing and results reporting. A DRC is likely to occur when a rate-related bundle branch block presents during exercise.

Arrhythmia detection is provided for the convenience of automatic documentation. The device offers no diagnostic opinion but provides documentation during the exam for which the operator renders their own medical opinion. Documentation is presented and stored for verification by a physician.

Risk Scoring

Duke Score

The Duke Score, a quantitative exercise treadmill score for predicting prognosis at Duke University, is present only when a Bruce protocol has been conducted and the patient presents ST change during the exam. Clinical assessment of the Duke Score can be chosen from a drop-down list with the following selections that will affect the resulting value.

- None (No angina)
- Non-limiting angina
- Exercise-limiting angina

The Duke Score is calculated using the following equation:

$$\text{Duke Score} = \text{Exercise Time (minutes)} - 5 * \text{Max Delta ST}(\mu\text{V})/100 - 4 * \text{Angina Score}$$

Functional Aerobic Impairment Percent (FAI%)

Percent of Functional Aerobic Impairment, or FAI %, is present only when a Bruce protocol has been conducted.

The FAI score is shown as a range from Sedentary to Active using the following calculation:

- Female Sedentary Lifestyle

$$\text{FAI} = (10035 - \text{Age} * 86 - 14 * \text{ExerciseTimeSeconds}) / (103 - \text{Age} * 86 / 100)$$

- Female Active Lifestyle

$$\text{FAI} = (10835 - \text{Age} * 86 - 14 * \text{ExerciseTimeSeconds}) / (111 - \text{Age} * 86 / 100)$$
- Male Sedentary Lifestyle

$$\text{FAI} = (13480 - \text{Age} * 111 - 14 * \text{ExerciseTimeSeconds}) / (144 - \text{Age} * 111 / 100)$$
- Male Active Lifestyle

$$\text{FAI} = (16455 - \text{Age} * 153 - 14 * \text{ExerciseTimeSeconds}) / (174 - \text{Age} * 153 / 100)$$

If the calculated FAI is less than 0 then the FAI displayed will be 0.

Maximum and Target HR/Workload

Target HR calculation with treadmill and pharmacological testing is based on age and percent of maximum predicted HR using 220 minus age, or 210 minus age, or 210 minus (0.65 x age).

Maximum workload with ergometer testing is calculated using the following formula:

$$\text{Max Workload Men} = 6.773 + (136.141 * \text{BSA}) - (0.064 * \text{Age}) - (0.916 * \text{BSA} * \text{Age})$$

$$\text{Max Workload Women} = 3.933 + (86.641 * \text{BSA}) - (0.015 * \text{Age}) - (0.346 * \text{BSA} * \text{Age})$$

$$\text{Where BSA} = 0.007184 * (\text{Height} ^ 0.725) * (\text{Weight} ^ 0.425)$$

Age in years / Height in cm / Weight in kg

Target HR or Target Workload can be calculated from a range of 75% to 100% in increments of 5%. Clinicians may also manually enter the target value they would like the patient to obtain.